

Cedar

Shed & Garden Kits

12x8 Garden in a Box Deer Fence Option Kit Assembly Manual

Made with North American Western Red Cedar

www.CedarShedAndGardenKits.com

info@CedarShedAndGardenKits.com

Thanks for your interest in the
8x12 Garden Box, John and Pat

**Delivery is Free from the
Factory to your Home, Farm,
Ranch or Business**

Please review this Assembly Manual
and the Spec Sheet thoroughly before
ordering. We want you to become
familiar with all of the tools required and
where and when assistants may be
necessary. More than anything we want
this to be successful and FUN!



**Estimated Assembly Time for
the Deer Fence Kit = 1 Hour.**

Deer Fence Height



Safety Equipment Required

(Not Provided)



Safety Glasses



Work Gloves

**In the event of a missing or broken piece, simply call the OLT Customer Support Line @
1-888-658-1658 within 30 days of the delivery of your purchase. It is our commitment to you to
courier replacement parts, free of charge, within 10 business days of this notification.
Replacement parts will not be provided free of charge after the 30 day grace period.**

*Cedar Shed and Garden Kits LLC is an Authorized Dealer of OLT Manufacturing
OLT reserves complete title and full intellectual property and copyright rights in any and all content within*

Exploded View and Parts List for 8x12 Raised Bed Deer Fence Option Kit

Parts List

- Part 1** 9 pcs - Side/Rear Deer Fence Panels (46"wide x 33 1/2"high)
- Part 2** 2 pcs - Door Deer Fence Panels (22 3/4"wide x 33 1/2"high)
- Part 4** 4 pcs - Corner Brackets (angle cut ends) (1 1/2" x 1 1/2" x 24")
- Part 5** 4 pcs - Vertical Panel Supports - Long (3/4" x 2 1/2" x 45")
- Part 6** 4 pcs - Vertical Panel Supports - Short (3/4" x 2 1/2" x 22")

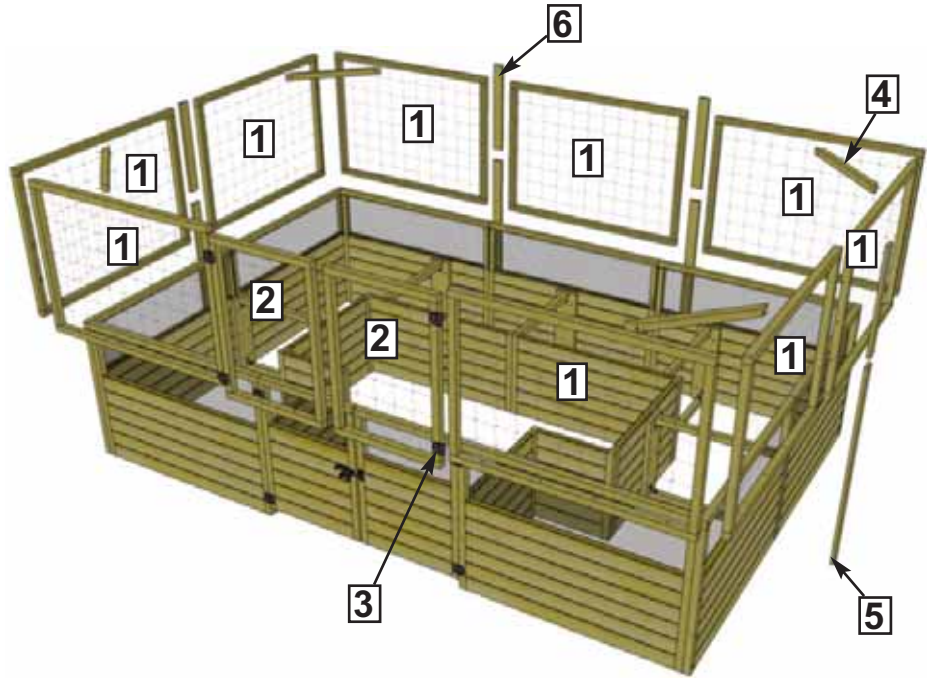

Hardware Kit (Provided)

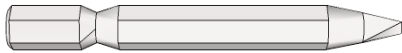

#2 Square Drive Bit x 1 pc



2 1/2" 8 pcs

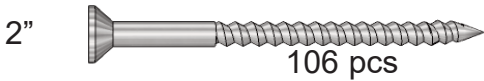

2" 106 pcs



3/4" Black 30 pcs



Part 3 - Black Plastic Butt Hinges - 4 pcs

Tools Required (Not Provided)



Screw Gun/Drill



1/8" Drill Bit



Level



Wood Clamp



Hammer



Tape Measure

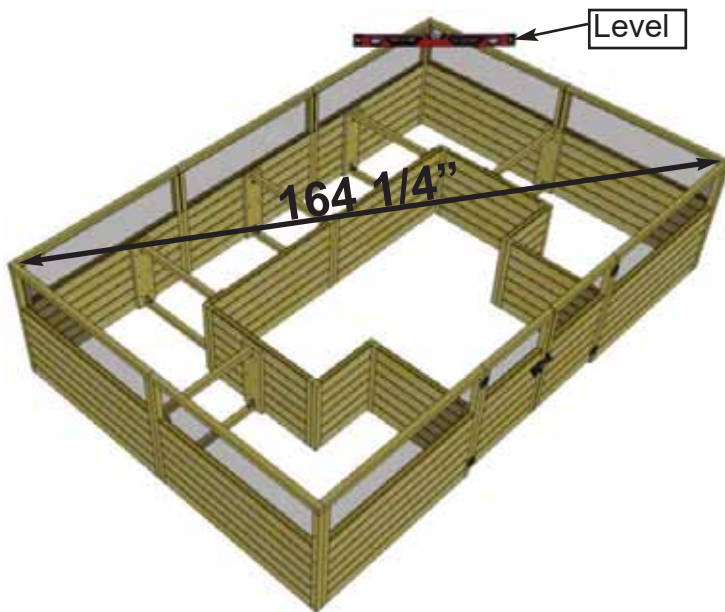

1. Prior to installing your Deer Fence Option Kit, confirm your 12x8 Raised Bed is level and square. Measure diagonally inside corner to corner (approximately 164 1/4") in both directions. Adjust as required. Use a level to determine if the tops of the bed frames are sloped and adjust if necessary.

We recommend filling your raised bed with soil prior to installing your Deer Fence Option Kit.

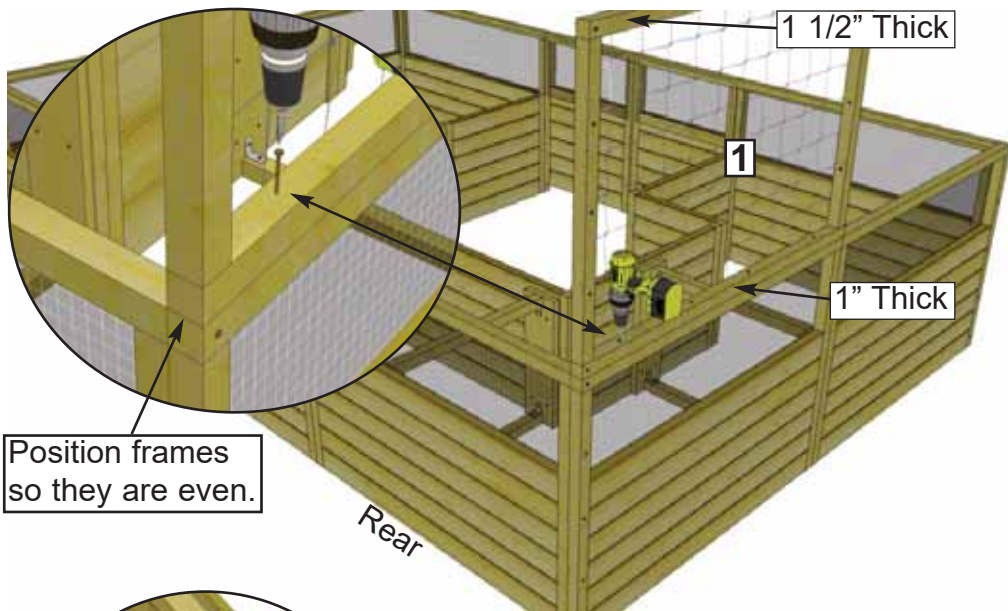

2. Starting on the side of the rear corner, position the frame of a **Side Panel (1) - 46" wide x 33 1/2" high** directly on top of the raised bed frame. Screw frames together with **4 - 2" Screws** as shown on the left. Install panels with the 1 1/2" thick side on top.

Expert Advice:
Use a Wood Clamp when positioning and attaching deer fence panels together.

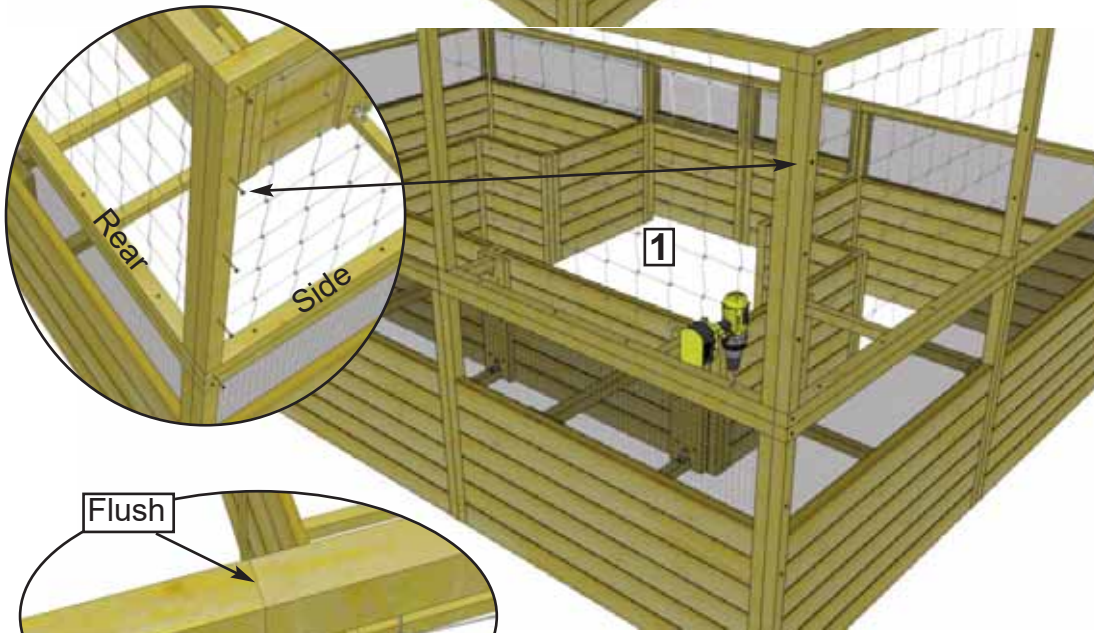

3. Position a **Rear Panel (1) - 46" wide x 33 1/2" high** directly on top of the side raised bed frame. Hold both deer fence frames together and starting at the top, screw together with **5 - 2" Screws** as shown on the left. Screw bottom of frame down to raised bed frame with **4 - 2" Screws**.

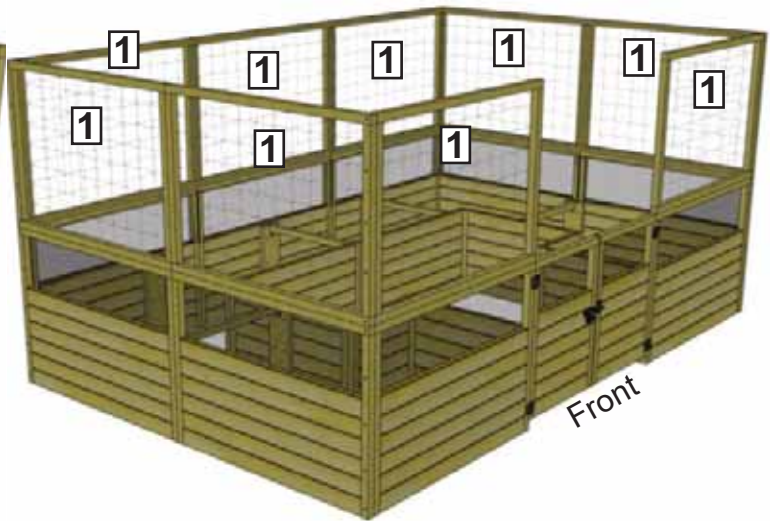
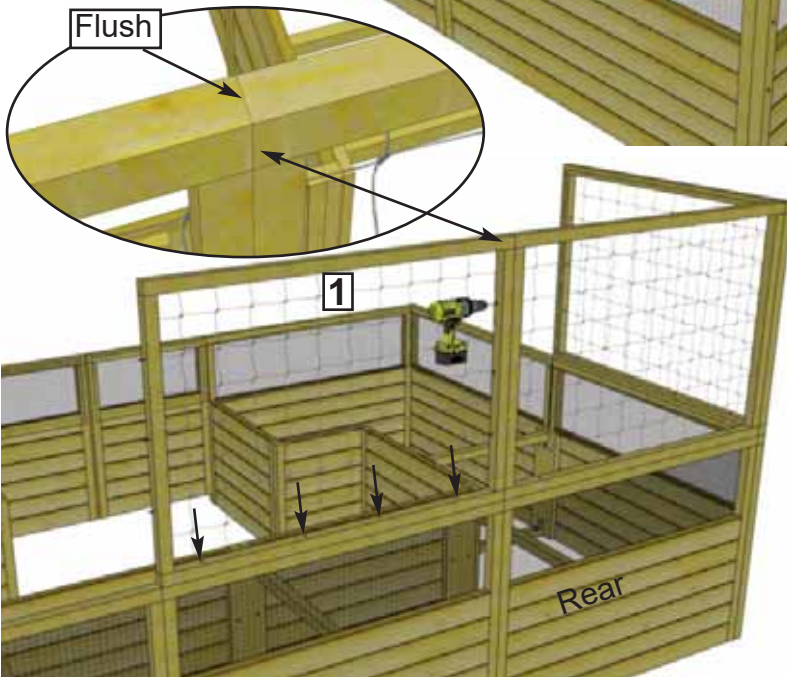

4. Position a second **Rear Panel (1) - 46" wide x 33 1/2" high** on top of the rear raised bed frame. Hold both rear deer fence frames together and starting at the top, screw together with **4 - 2" Screws** as shown above. Screw bottom of frame down to raised bed frame with **4 - 2" Screws**. Complete remaining side and rear panels attachments following **Steps 2 and 3**.

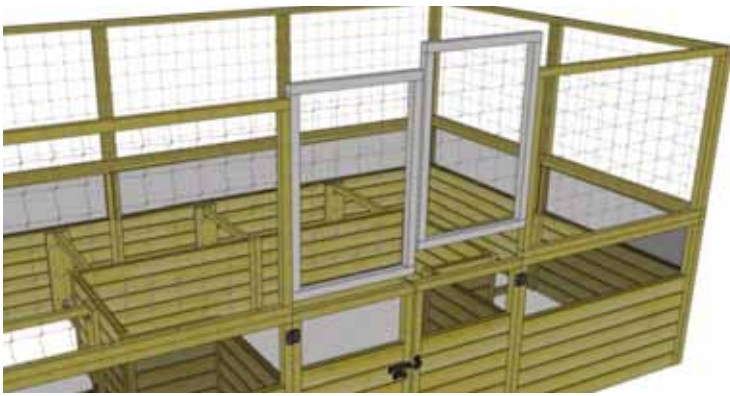

5. Locate both **Deer Fence Door Panels (2) - 22 3/4" wide x 33 1/2" high**. Position and install both Door Panels, screwing only from bottom frame into top of raised bed door frame with **3 - 2" screws** per panel as shown above.

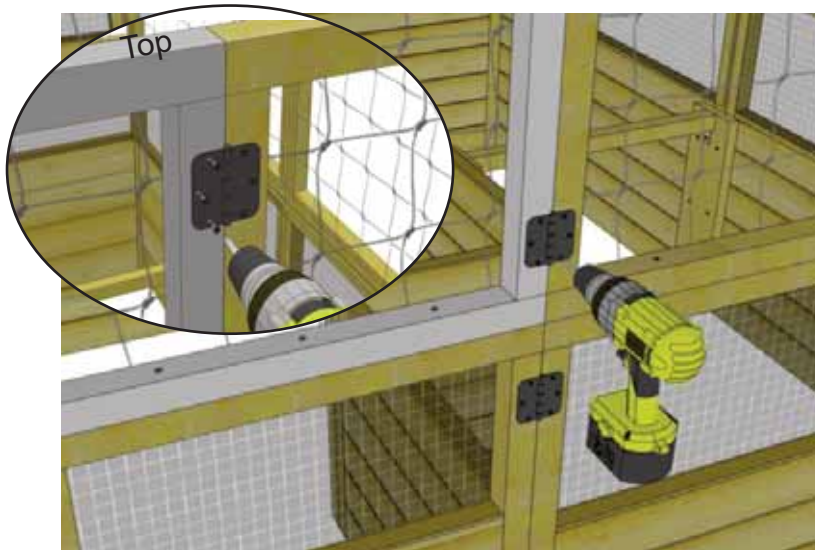

6. Locate all four **Black Plastic Hinges (3)** and attach to deer fence frame with **6 - 3/4" black screws** per hinge as shown above. Use 1/8" drill bit to pilot hole shallow holes before attaching to avoid splitting deer fence framing. Open and close door to check door aligned correctly. Adjust as required.

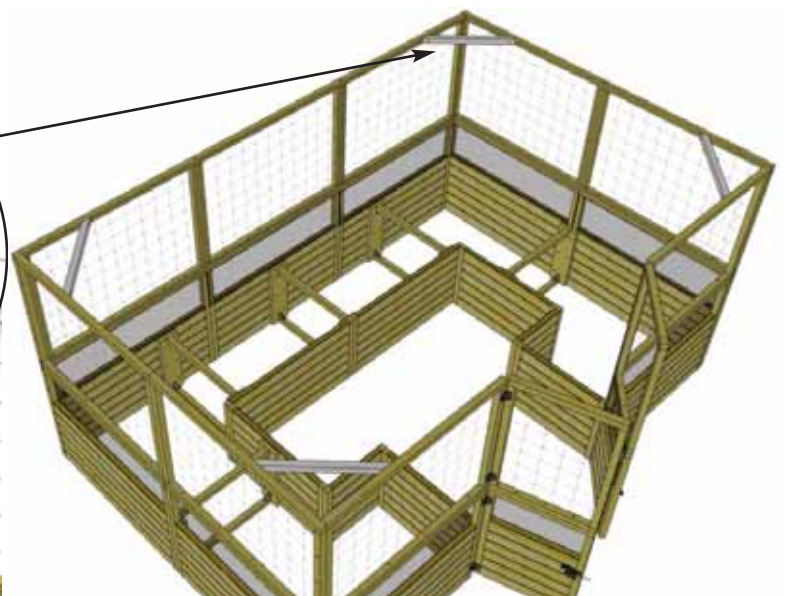
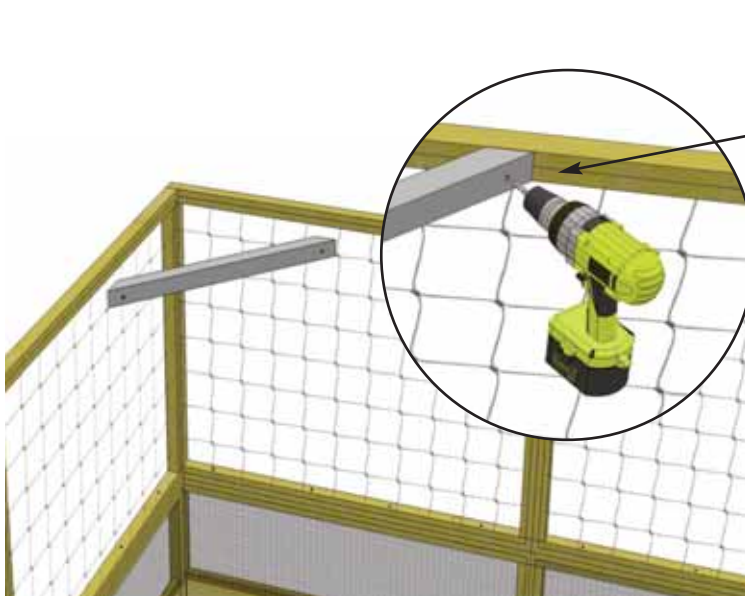

7. Attach **Corner Brackets with angle cut ends - (4)** on the inside frames at the top. Use **2 - 2 1/2" Screws** per bracket. Screw on an angle. Pre-drill ends with 1/8" drill bit to prevent wood splitting.

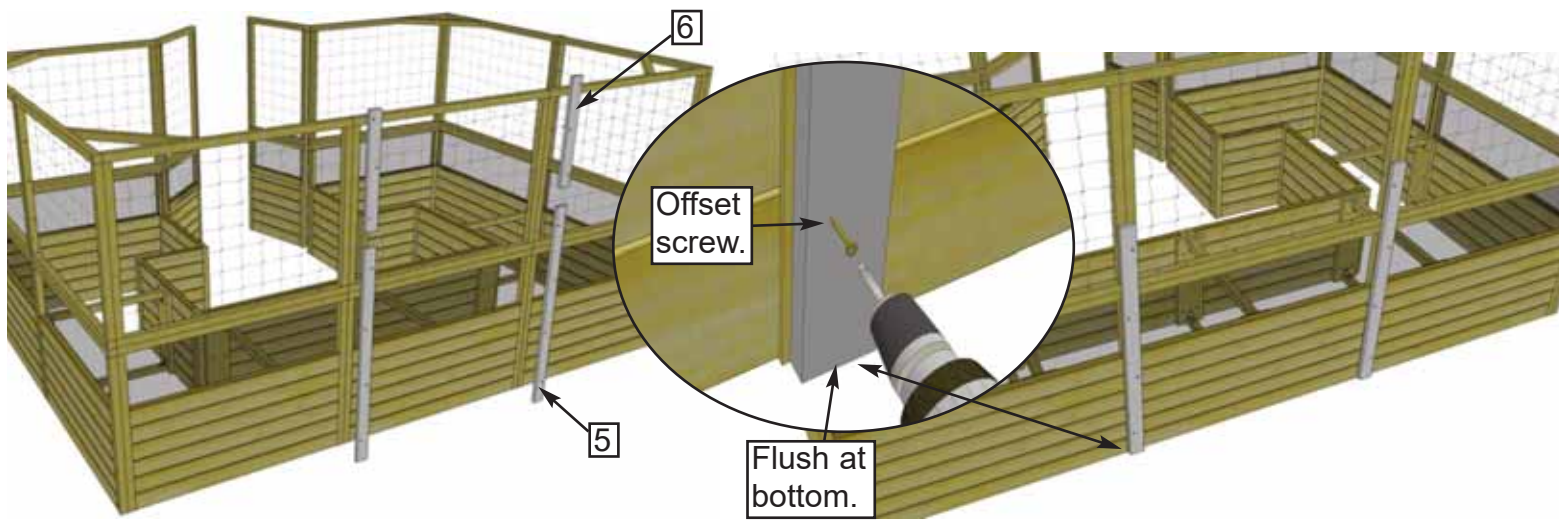

8. Locate **Vertical Panel Supports - Long (5) - 3/4" x 2 1/2" x 45"** and **Vertical Panel Supports - Short (6) - 3/4" x 2 1/2" x 22"**. Starting with 45" long support first, center on panel frames, flush at bottom and attach with **4 - 2" Screws**. Offset the screw to either side of the support to ensure you contact the heart of the bed frame.

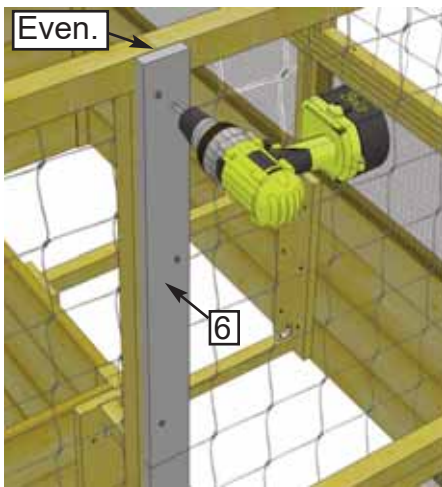

9. Position and attach short Vertical Panel Support using **3 - 2" Screws** as per Step 7. Complete remaining rear and side walls.

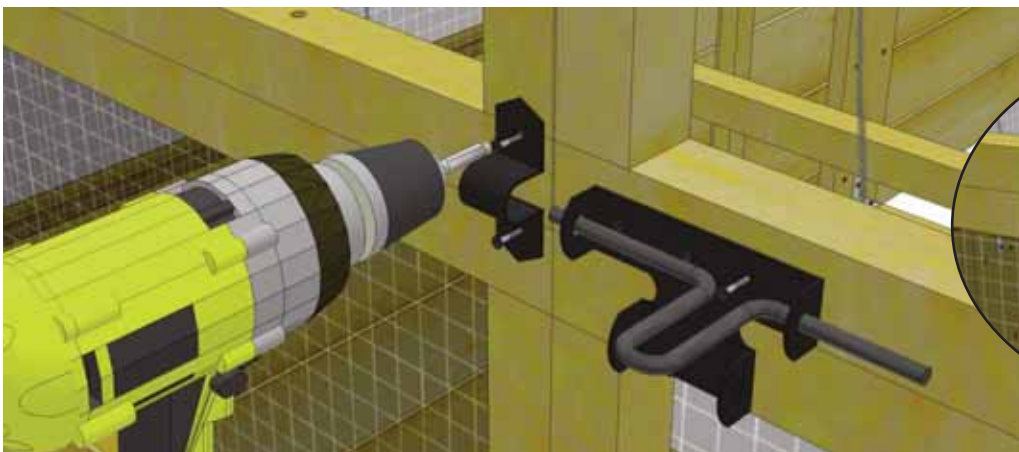

10. Attach Black Barrel Bolt to door and panel frame using **6 - 3/4" Black Screws**. Note how female part of Barrel Bolt is positioned higher than male. Do a dry run first to position Barrel Bolt correctly, then attach. Pre-drill with 1/8" drill bit to prevent wood from splitting.

Made with North American Western Red Cedar

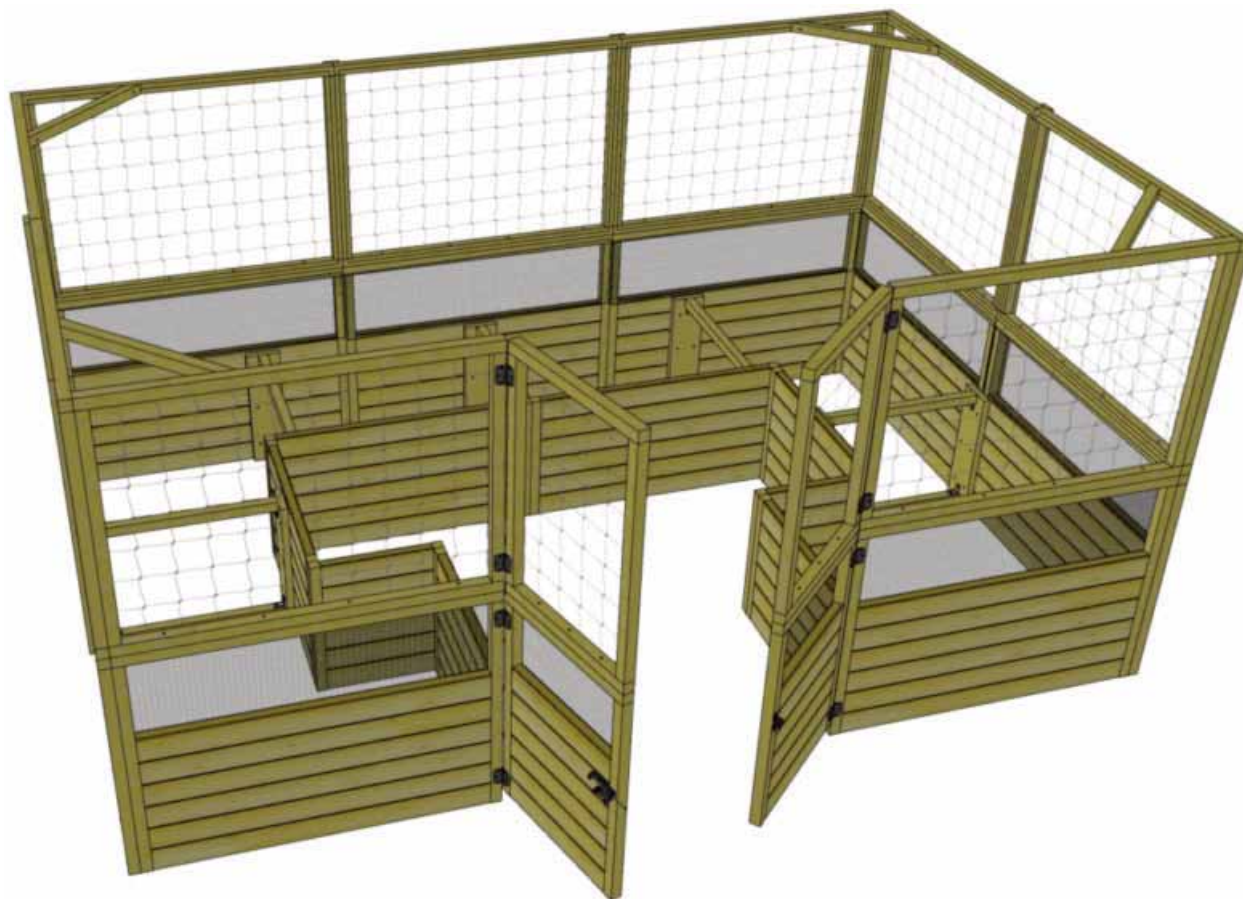

We value your feedback and would like to hear back from you on how well we are doing in the following areas:

- 1. Customer Service**
- 2. On Time Shipping**
- 3. Motor Freight Delivery**
- 4. Quality of Materials**
- 5. Assembly Manual**
- 6. Overall Satisfaction.**

**Please email John and Pat Motley
info@CedarShedandGardenKits.com**

The materials contained in this Assembly Manual may be downloaded or copied provided that ALL copies retain the copyright and any other proprietary notices contained on the materials. No material may be modified, edited or taken out of context such that its use creates a false or misleading statement or impression as to the positions, statements or actions.