

Cedar

Shed & Garden Kits

8x12 Garden in a Box with Greenhouse Cover Assembly Manual

Made with North American Western Red Cedar

www.CedarShedAndGardenKits.com

info@CedarShedAndGardenKits.com

**Thanks for your interest in the
8x12 Greenhouse, John and Pat**

**Delivery is Free from the
Factory to your Home, Farm,
Ranch or Business**

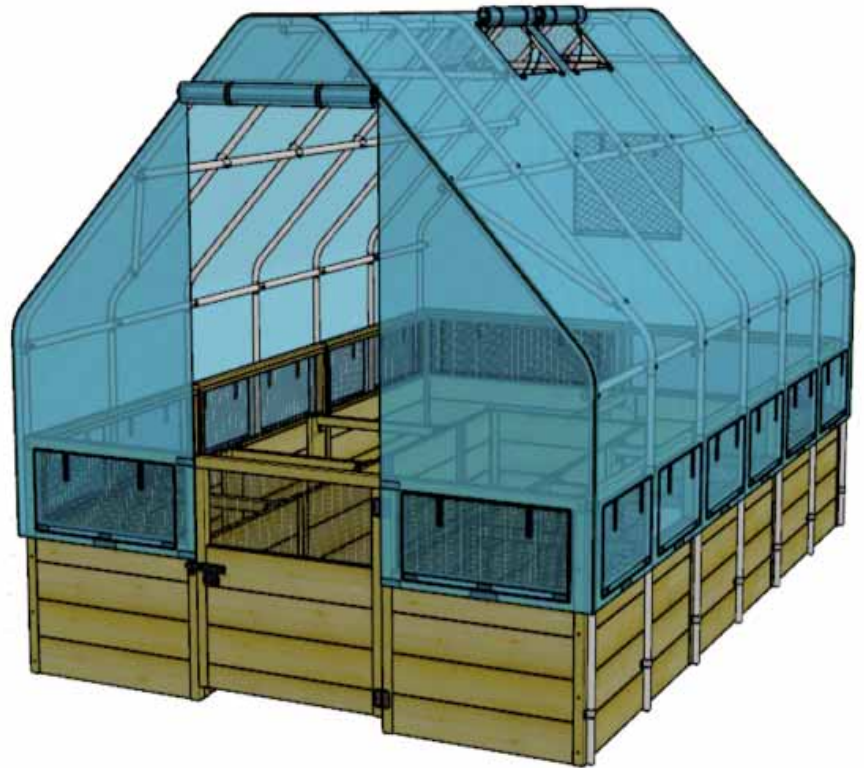

Please review this Assembly Manual and the Spec Sheet thoroughly before ordering. We want you to become familiar with all of the tools required and where and when assistants may be necessary. More than anything we want this to be successful and FUN!

In colder climates, please remove your Garden in a Box Plastic Cover during the winter months and store in included bag in a dry warm location ~ Do not leave cover on during any large snow storms or extreme weather phenomenon such as hurricanes, tornadoes or heavy wind storms ~ Cover can easily be taken off in minutes if such weather patterns are forecast in your area ~ We recommend once a year in the early spring to check that all fasteners are snug and to tighten if loose ~ Plastic cover can be cleaned with a mild soap and a cloth.











Customer agrees to hold Outdoor Living Today and Cedar Shed and Garden Kits LLC, Authorized Dealer, free of any liability for improper installation, maintenance and repair.

In the event of a missing or broken piece, call the OLT Customer Support Line @ 1-888-658-1658 with-in 30 days of the delivery of your purchase. It is our commitment to you to courier replacement parts, free of charge, within 10 business days of this notification. Replacement parts will not be provided free of charge after the 30 day grace period.

All structures purchased from OLT are covered for a period of one year for defects in manufacturing and workmanship. Costs incurred for customer installations are not included.

Failure to use supplied parts included in this kit could result in poor product performance and may void your warranty. Please contact OLT's Customer Toll Free Line if you plan to deviate from our written instructions.

*Cedar Shed and Garden Kits LLC is an Authorized Dealer of OLT Manufacturing
OLT reserves complete title and full intellectual property and copyright rights in any and all content within*

Part 1		x 14
Part 2		x 5
Part 3		x 20
Part 4		x 5
Part 5		x 6
Part 6		x 12
Part 7		x 2
Part 8		x 3
Part 9		x 4
Part 10		x 3
Part 11		x 4

Hardware & Miscellaneous

56 x S2 - 1 1/4" Screws



2 x M6x60



33 x M6x55



10 x M6x35



2 x Protective Stripping Rolls (40ft each)



16 x Clips

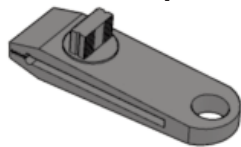

16 x 1 1/4" Pan Head Screws

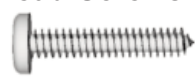

Greenhouse Cover

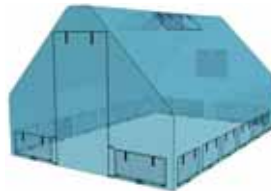

1 x BR1 - Square Drive Bit



Storage Bag



16 x Washers



28 x Pipe Clamps



Tools Required

(Not Provided)



Screw Gun/Drill





Pliers

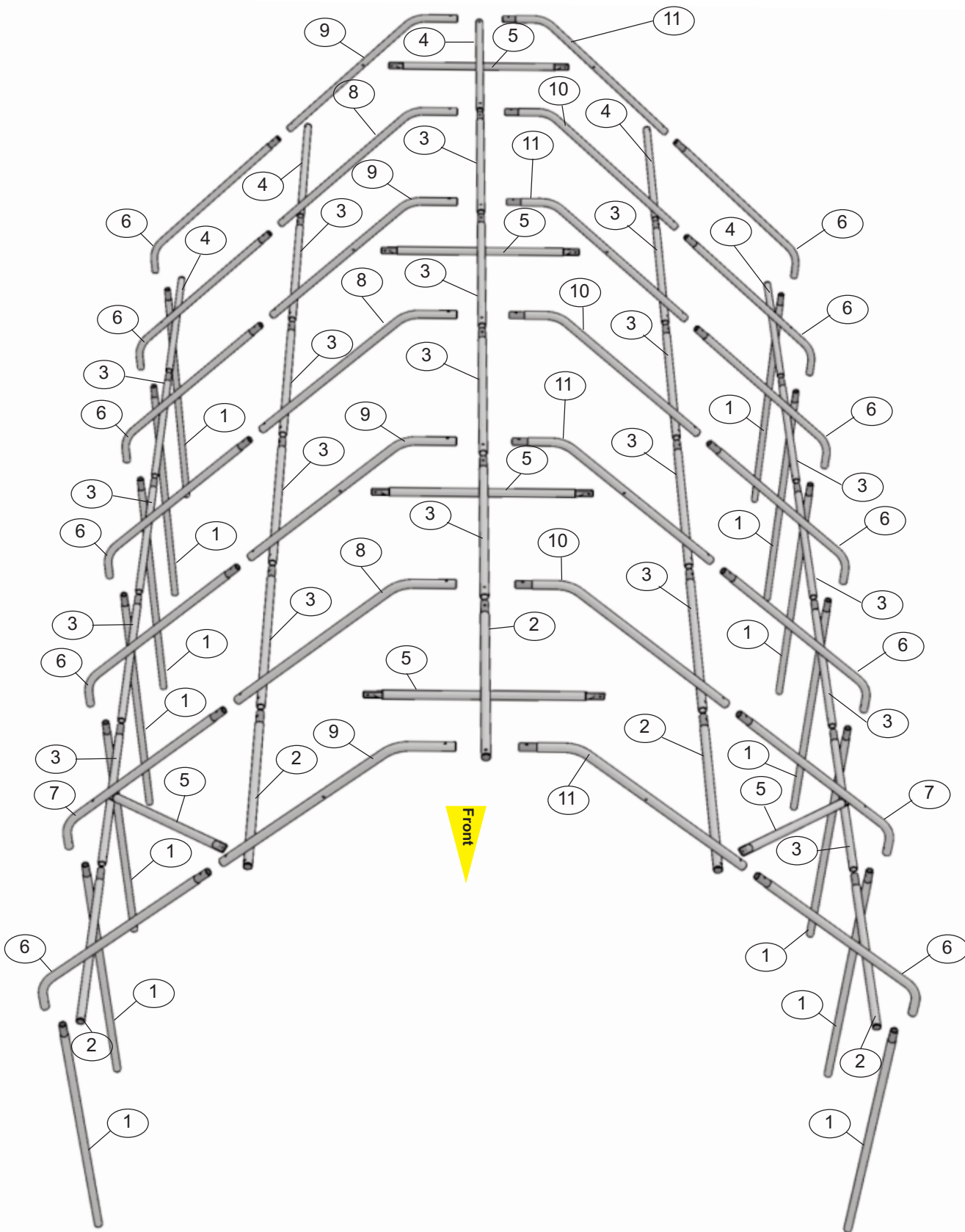

Phillips Screwdriver

Exploded View



Step	Parts & Hardware	
	1	1 x Part 4
1 x Part 9		1 x M6x55
		

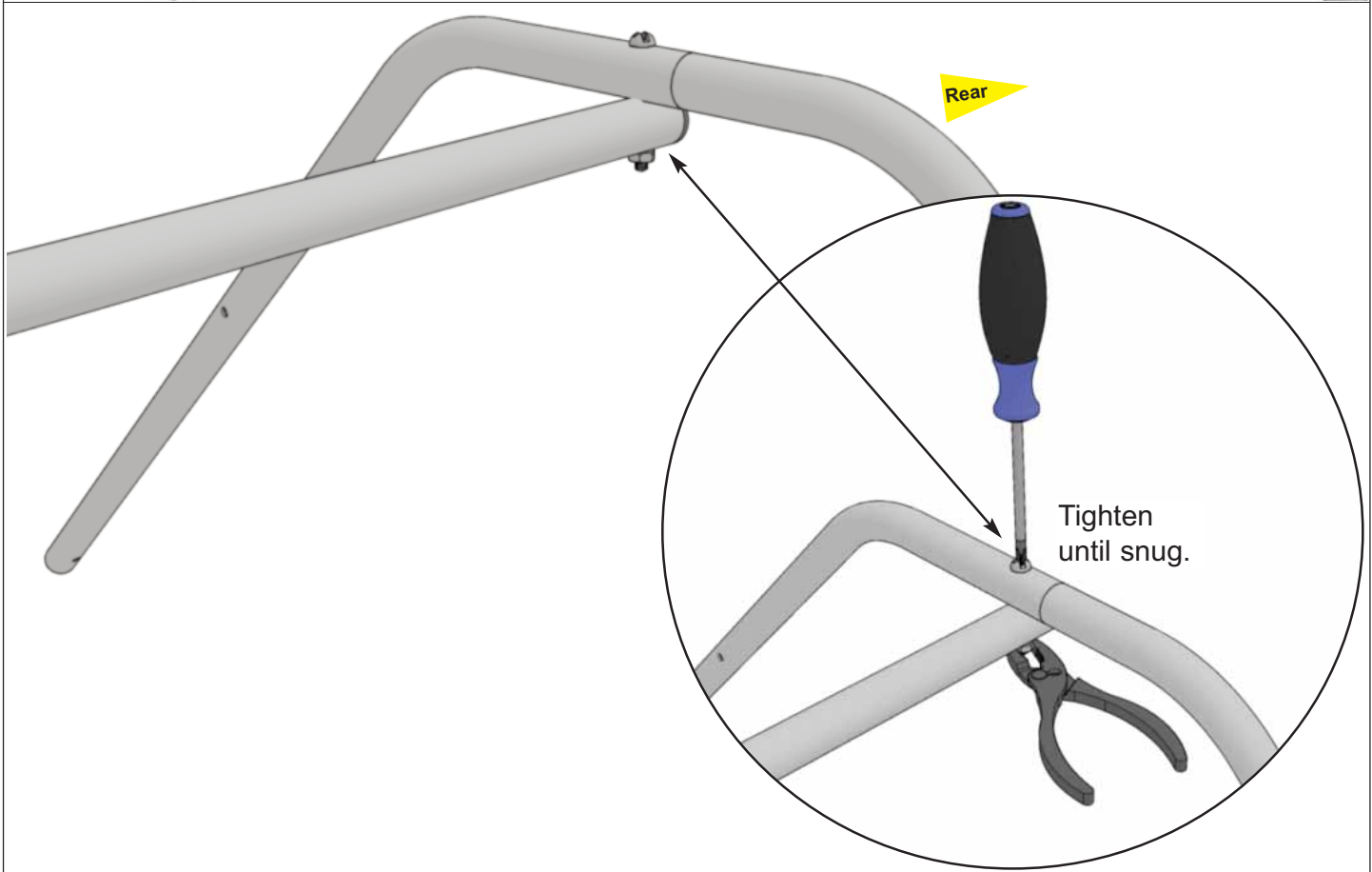
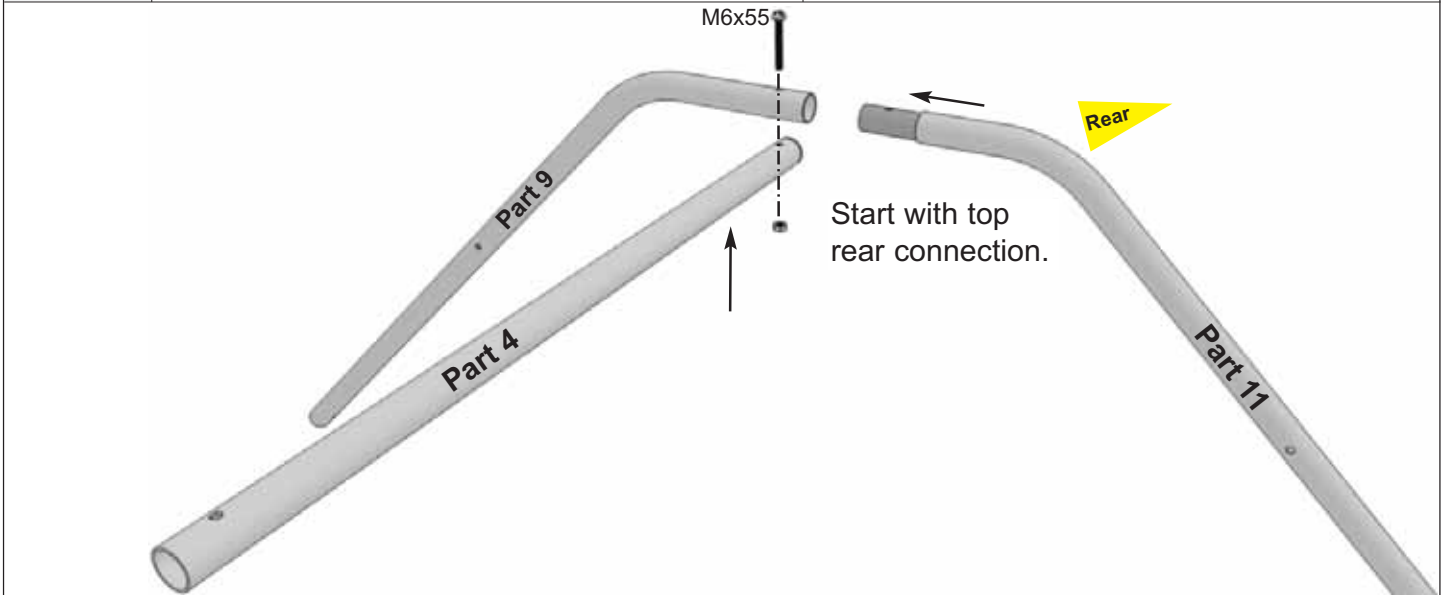

Step

2

Parts & Hardware

1 x Part 5



2 x M6x35

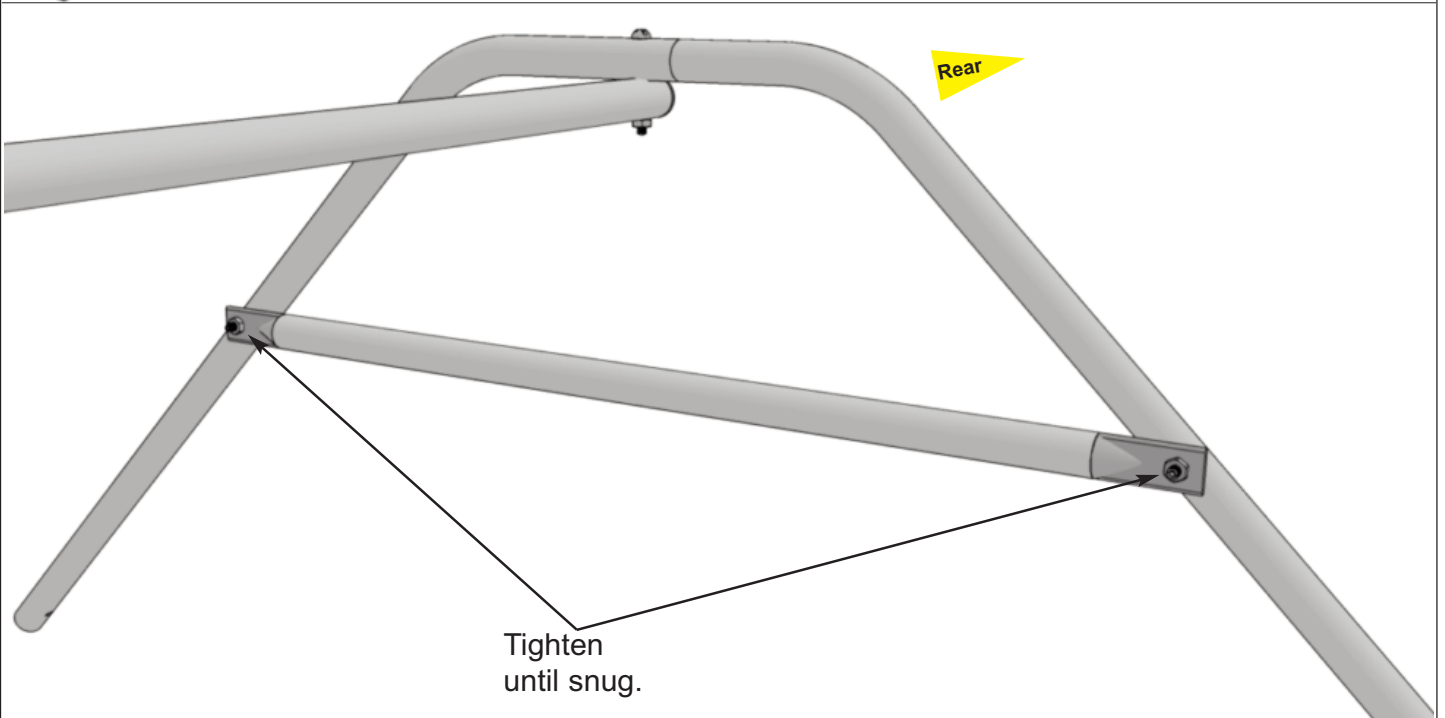
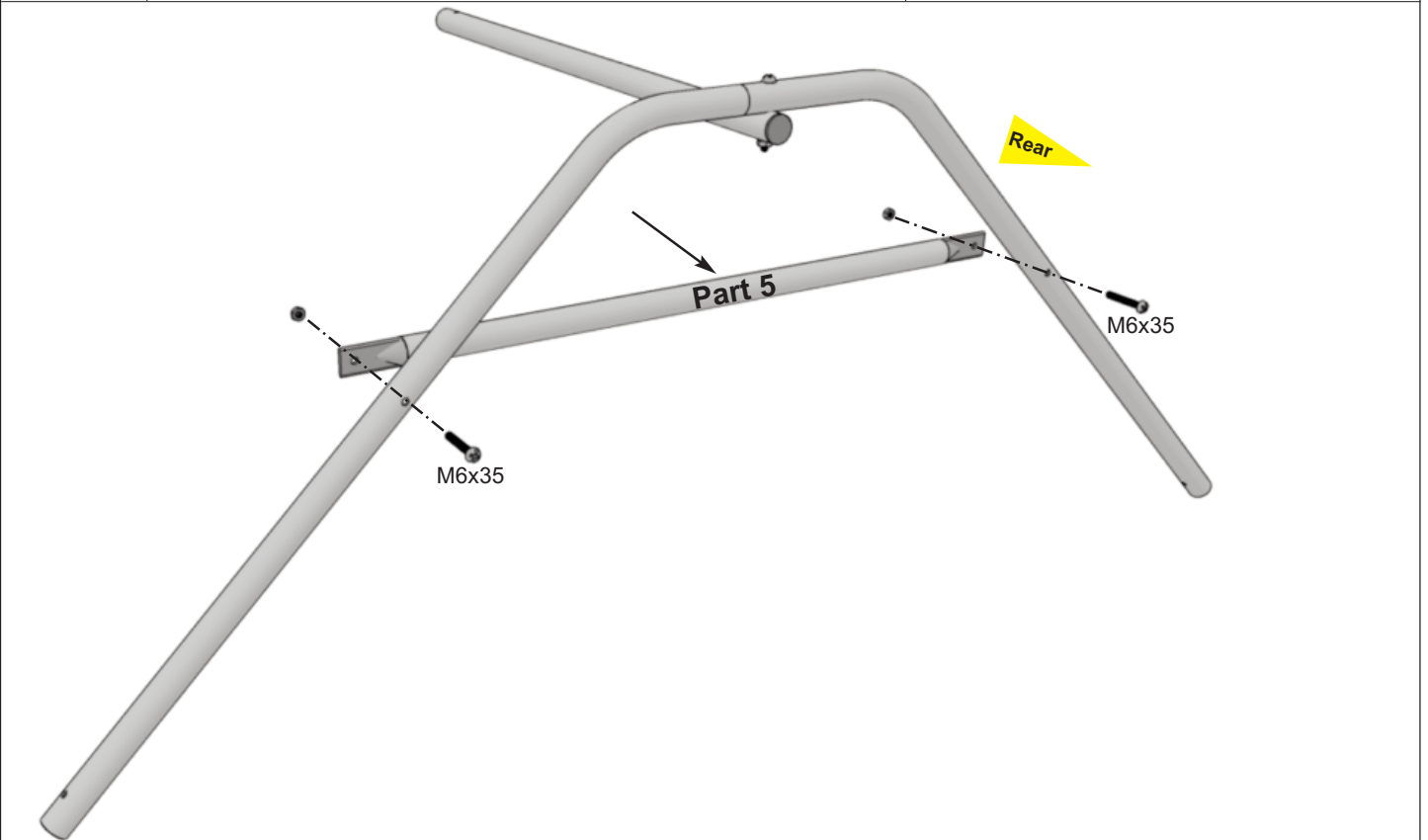

Step 3	Parts & Hardware	
	1 x Part 3	1 x Part 10
	1 x Part 8	1 x M6x55

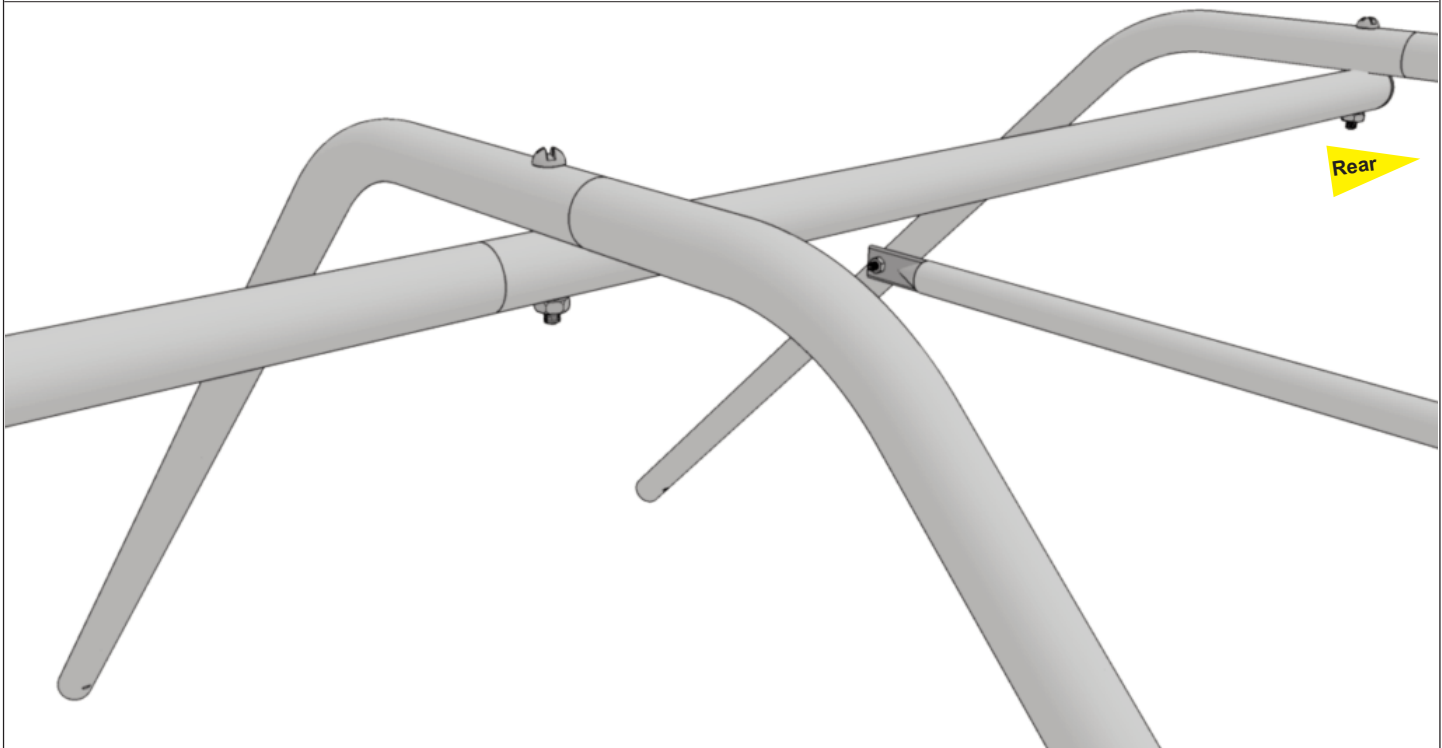
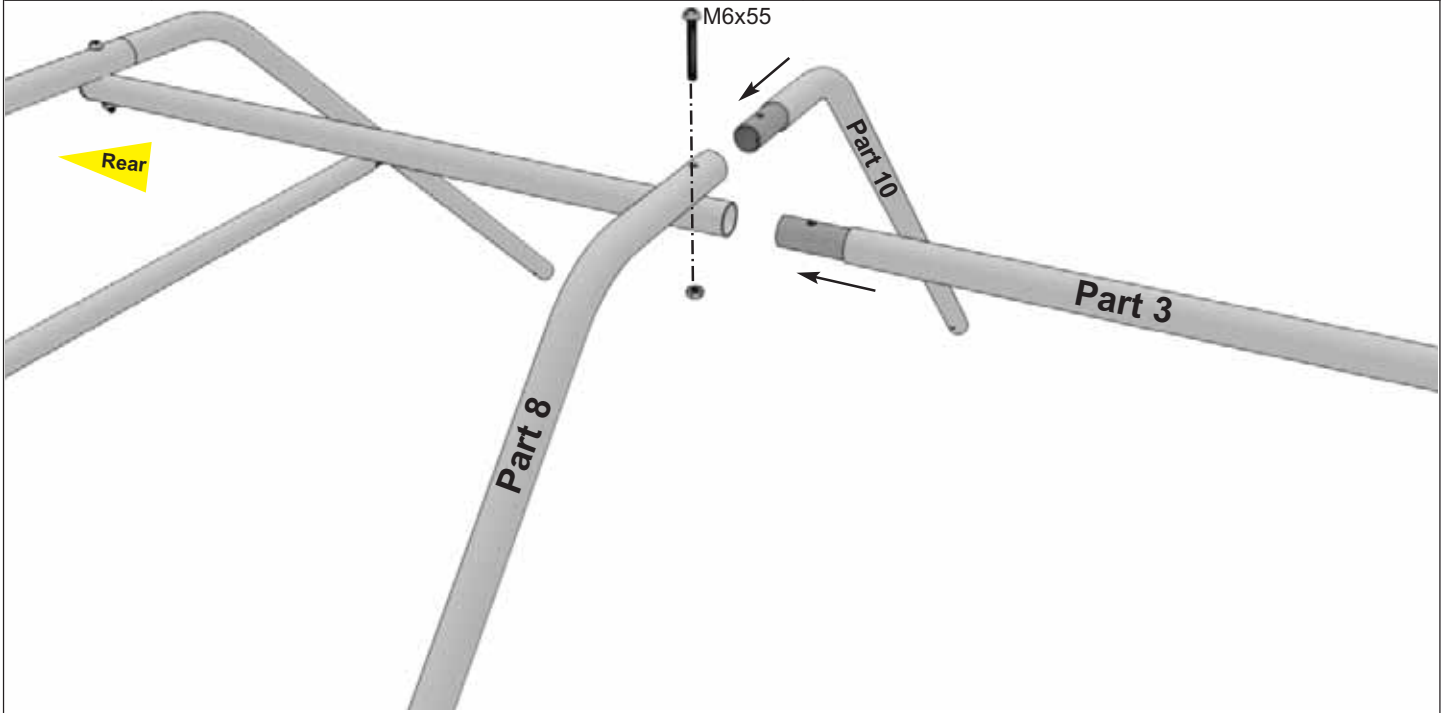

Step 4	Parts & Hardware	
	2 x Part 8	2 x Part 10
1 x Part 2	3 x Part 3	
3 x Part 9	3 x Part 11	
6 x M6x35	5 x M6x55	3 x Part 5

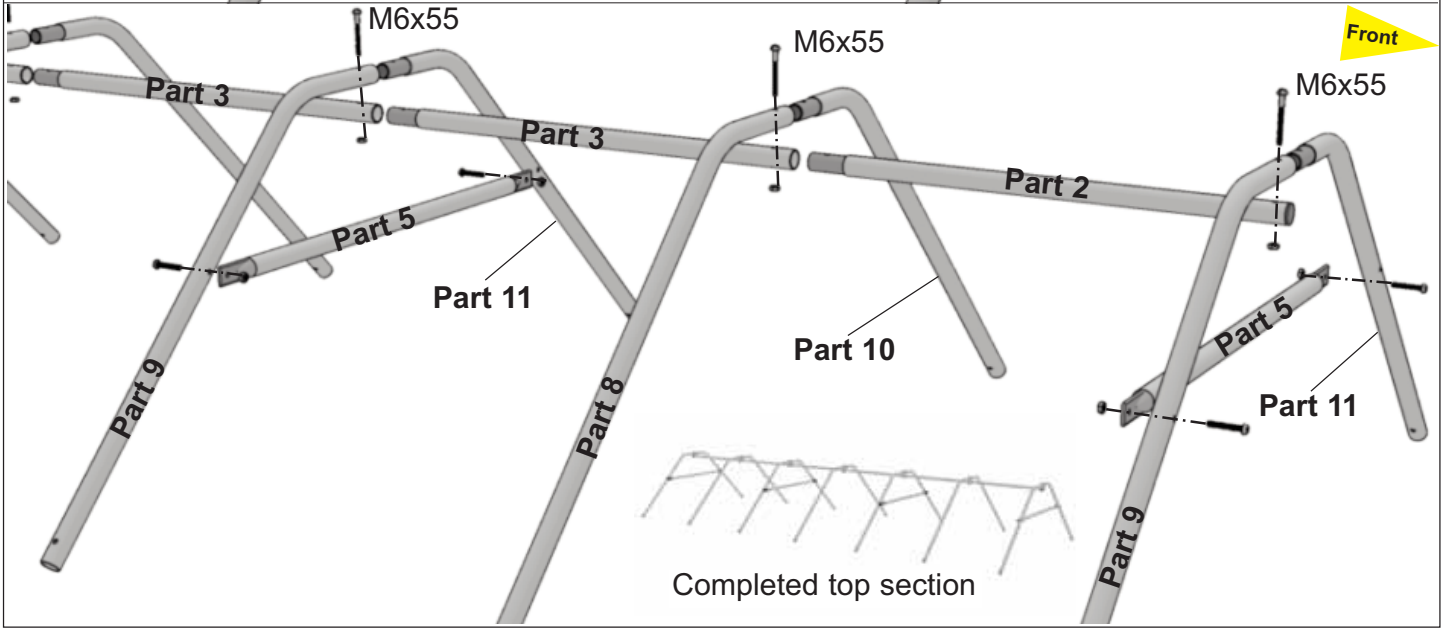
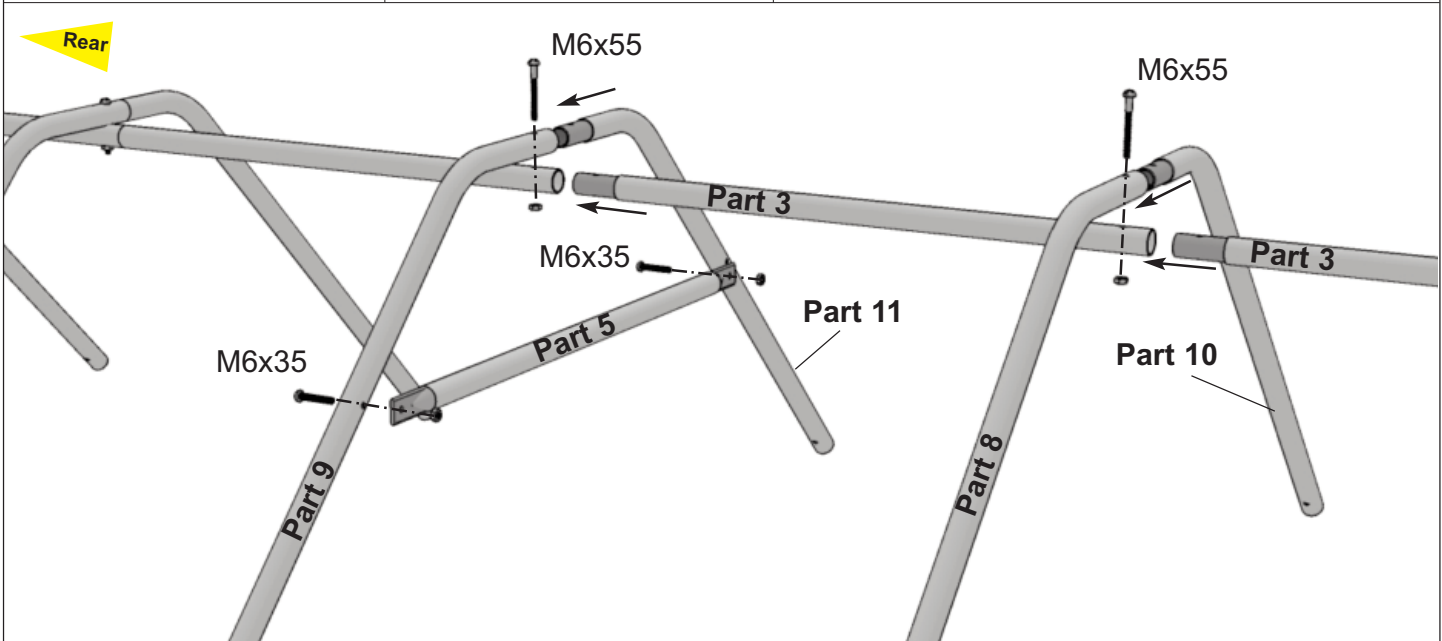

Step	Parts & Hardware		
	5	1 x Part 7	6 x Part 6
1 x Part 4		4 x Part 3	
1 x Part 2		1 x Part 5	
1 x M6x35		6 x M6x55	1 x M6x60

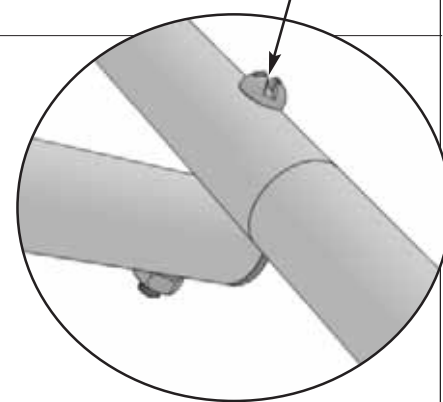
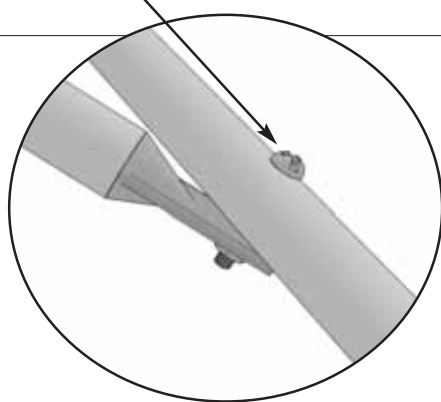
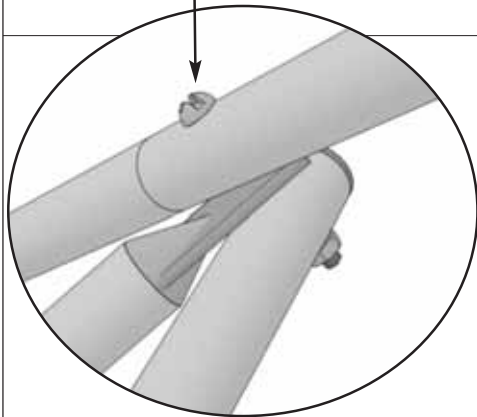
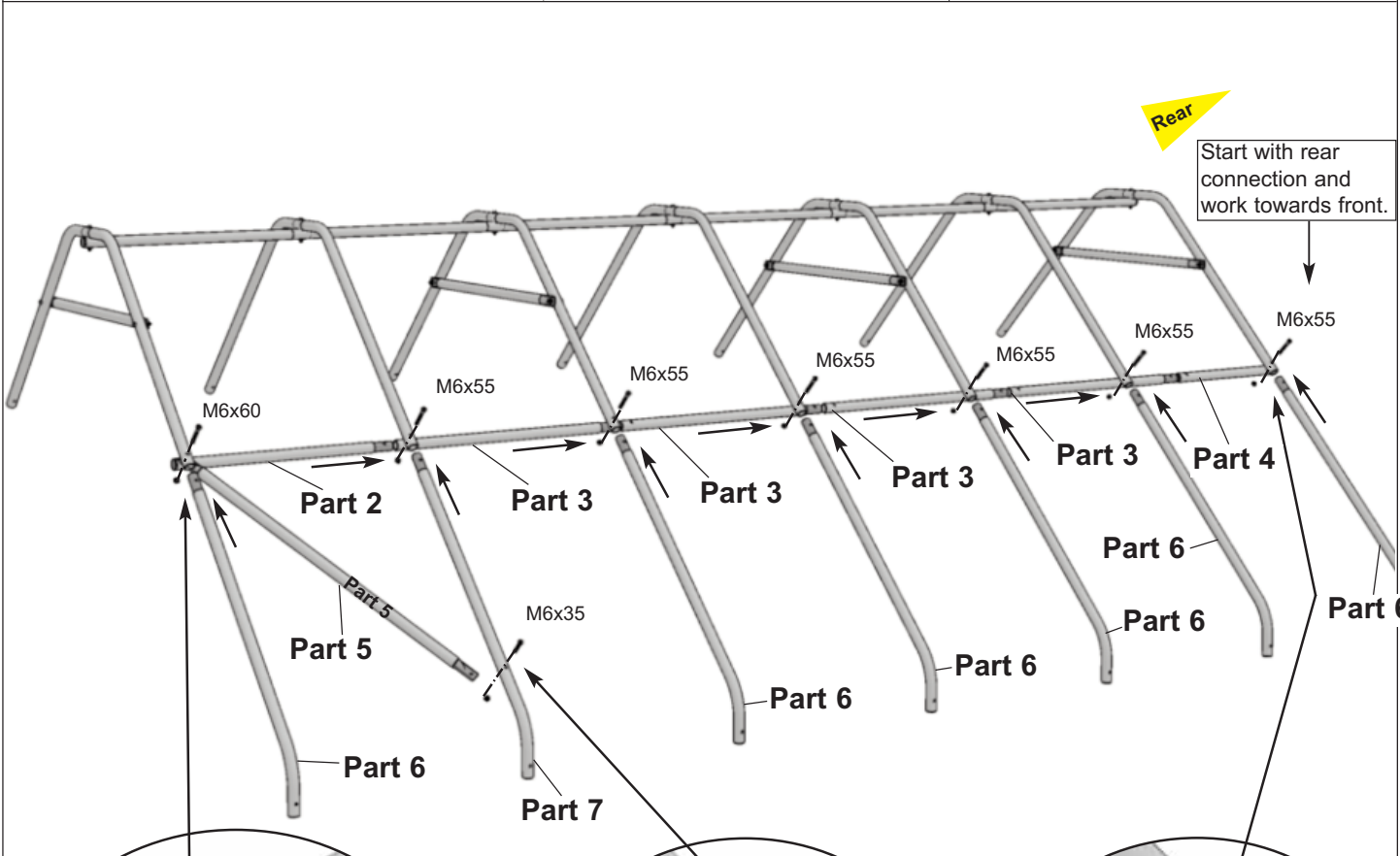

Step 6	Parts & Hardware	
	1 x Part 7	6 x Part 6
	1 x Part 4	4 x Part 3
	1 x Part 2	1 x Part 5
1 x M6x35	6 x M6x55	1 x M6x60

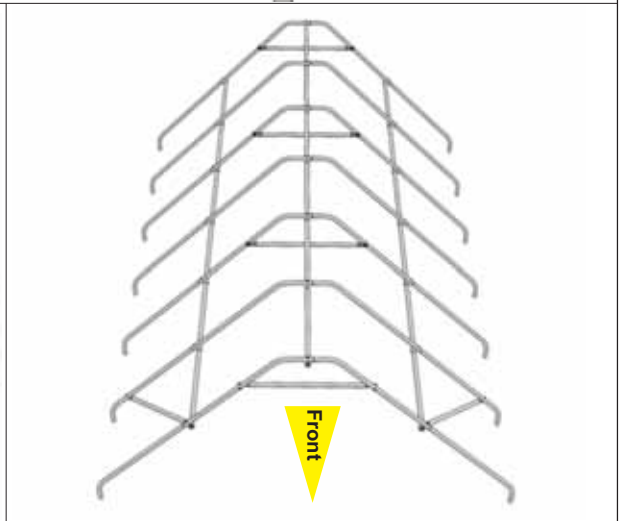
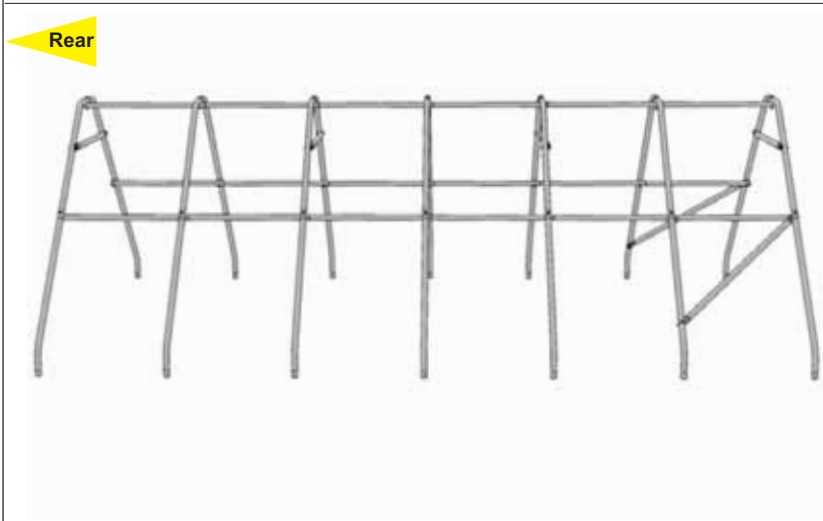
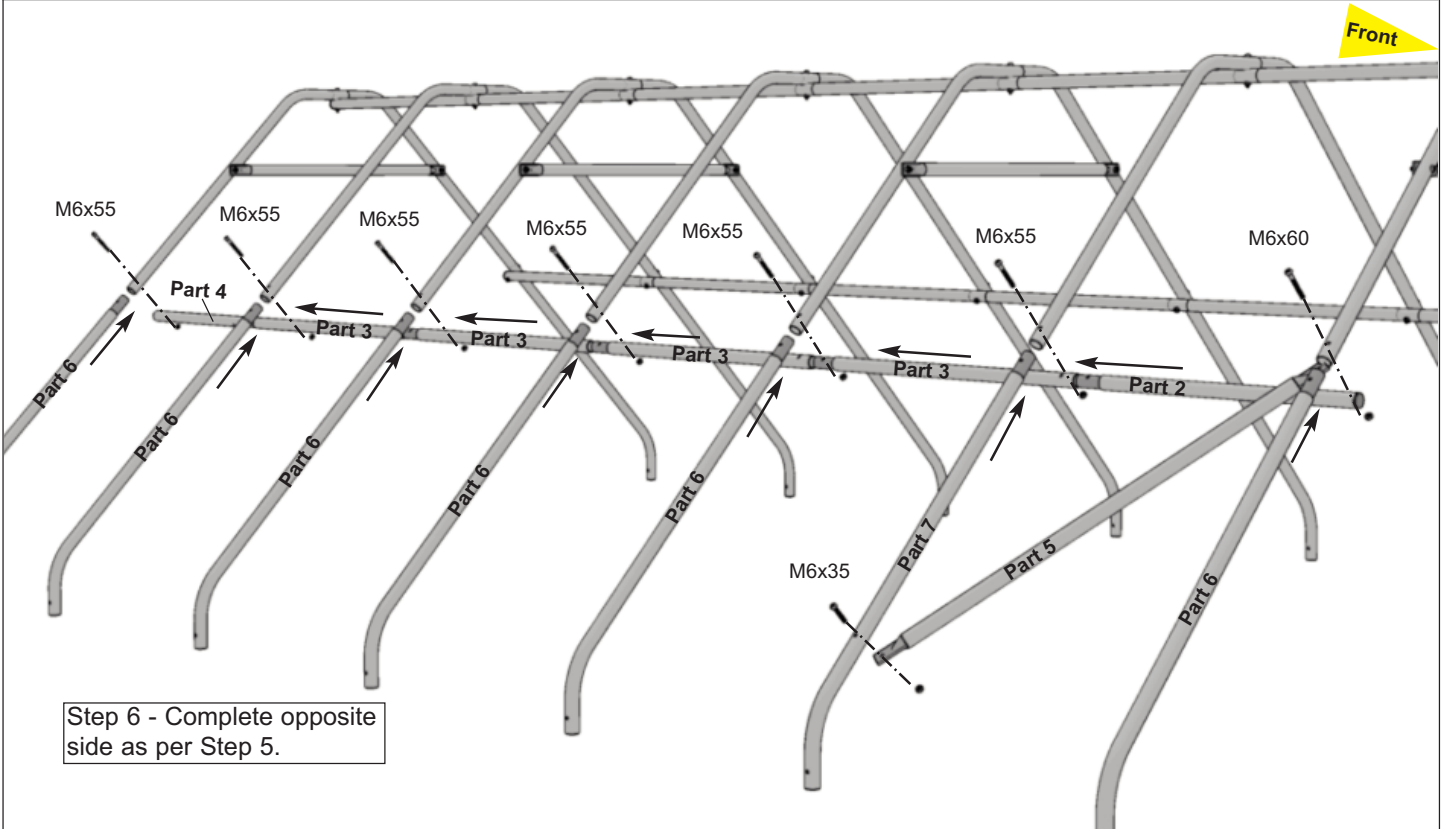

Step

7

Parts & Hardware



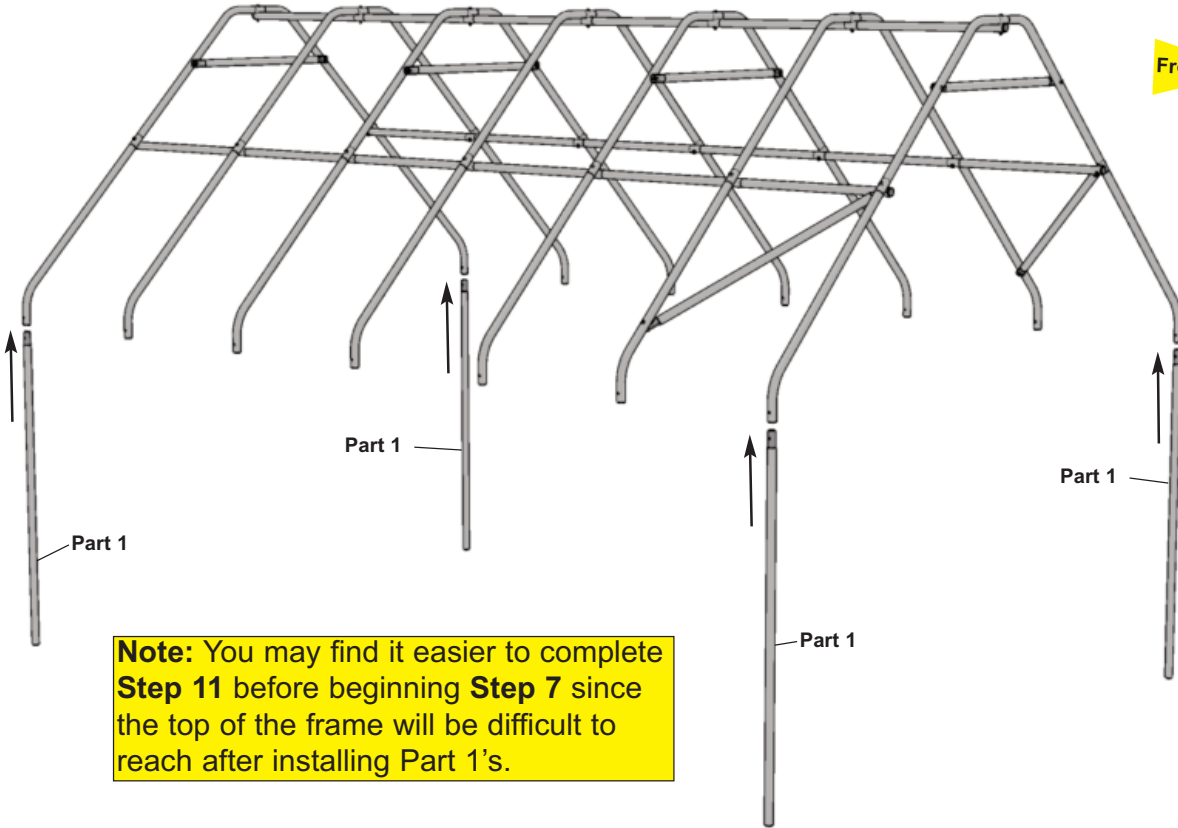

14 x Part 1

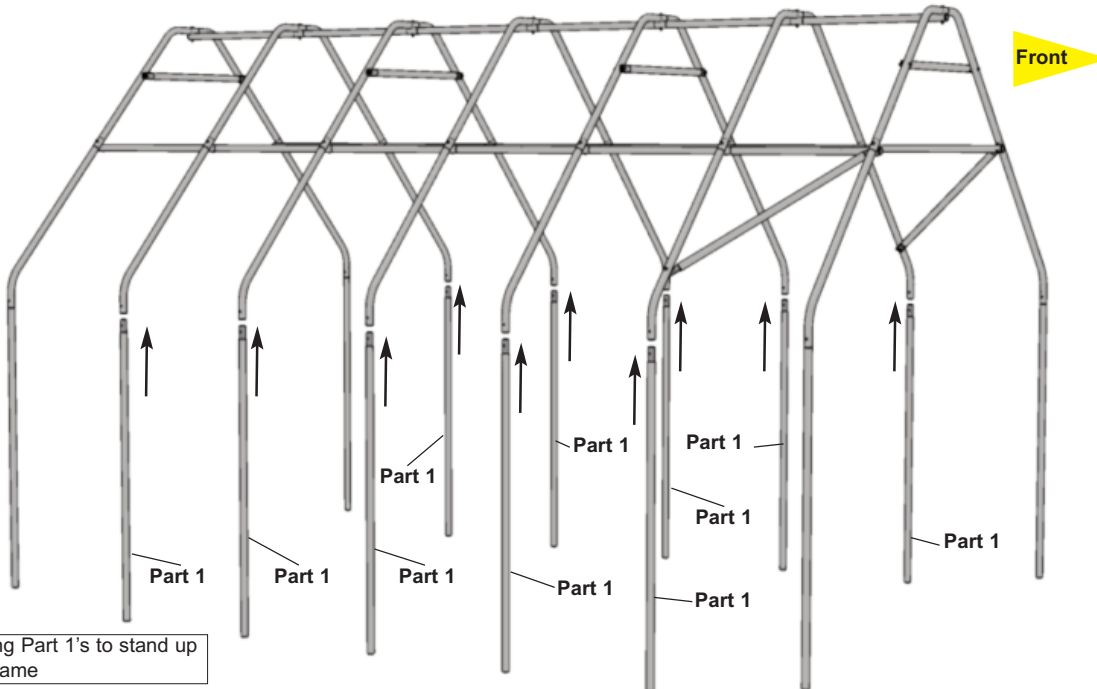

Note: You may find it easier to complete **Step 11** before beginning **Step 7** since the top of the frame will be difficult to reach after installing Part 1's.



Insert remaining Part 1's to stand up Greenhouse frame

Step 8	Parts & Hardware	
	8 x Part 3 	14 x M6x55 
	2 x Part 2 	2 x Part 4 

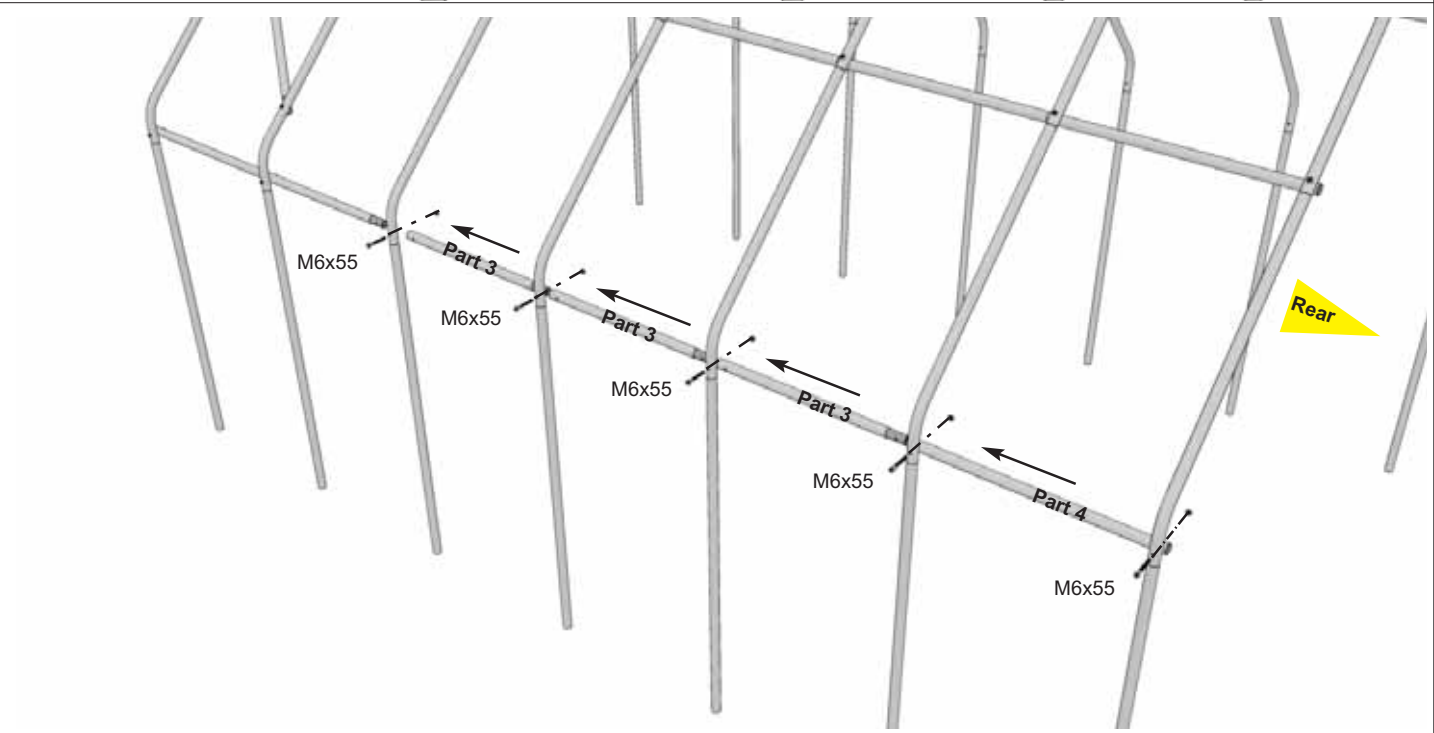
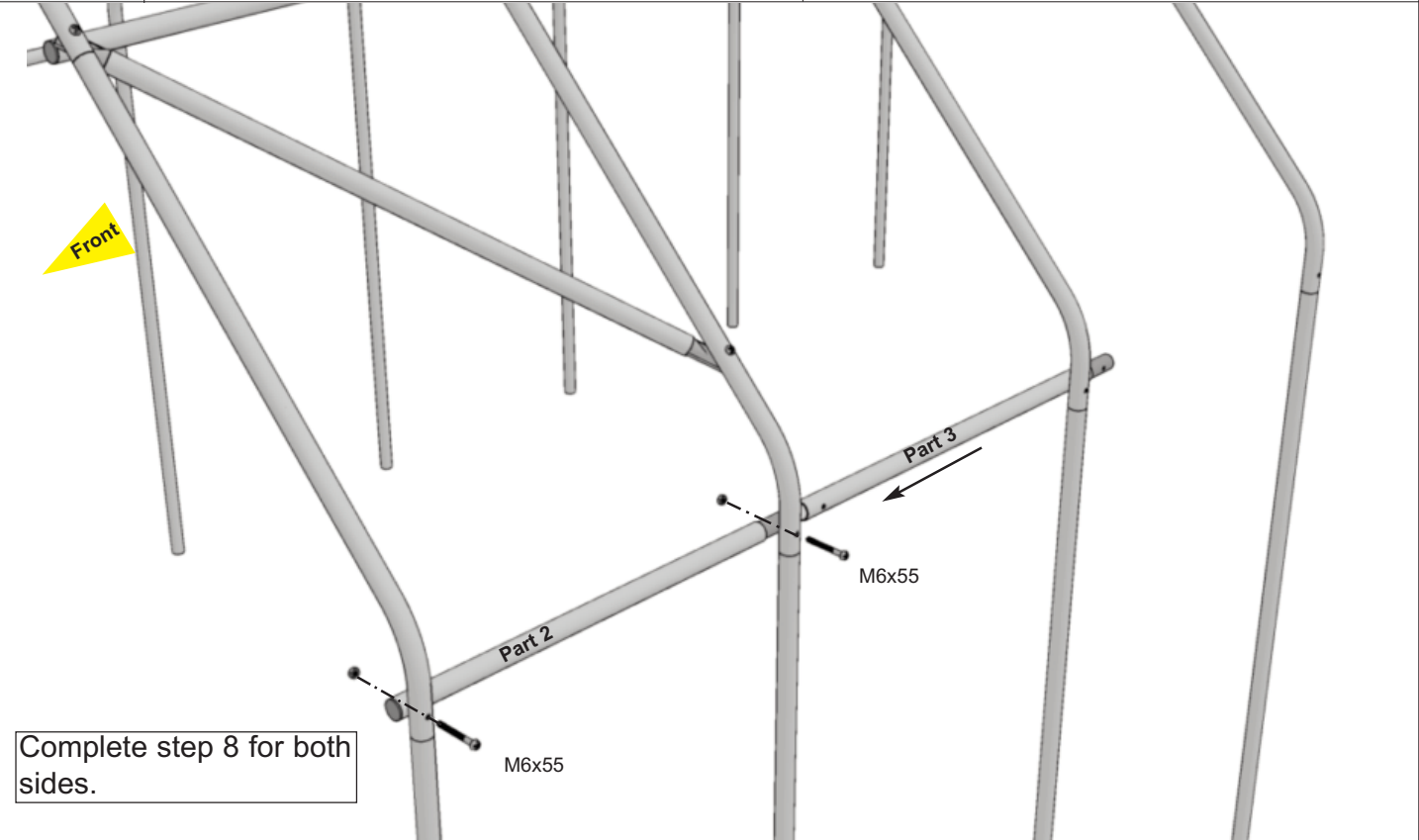

Step
9

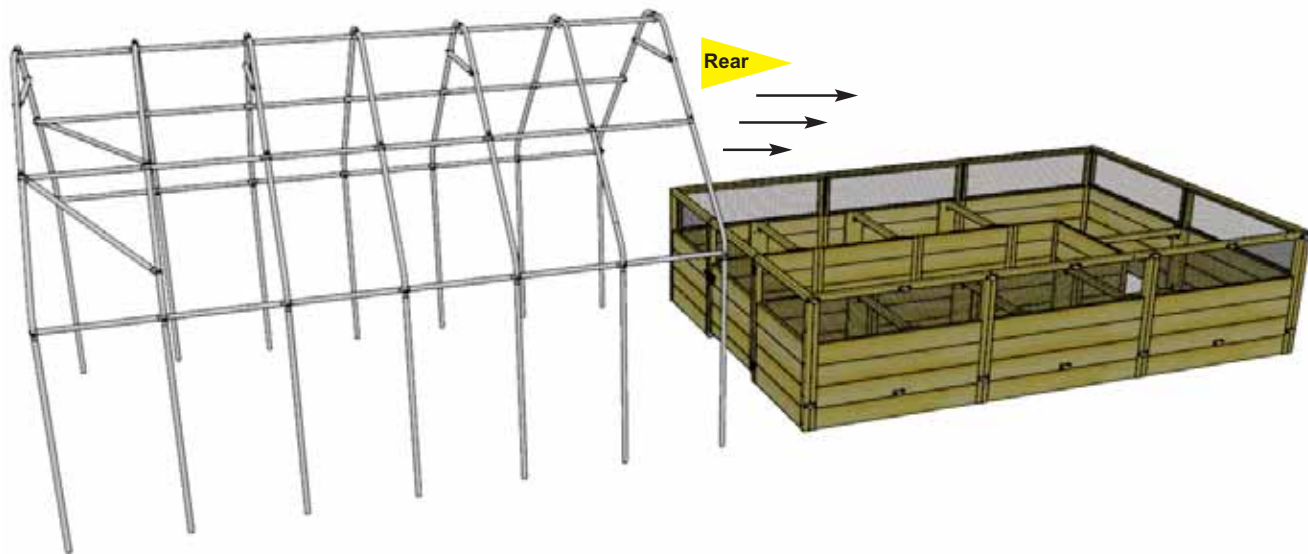

Step
10

Parts & Hardware

28 x Y34 - Pipe Clamps



56 x S2 - 1 1/4" Screws

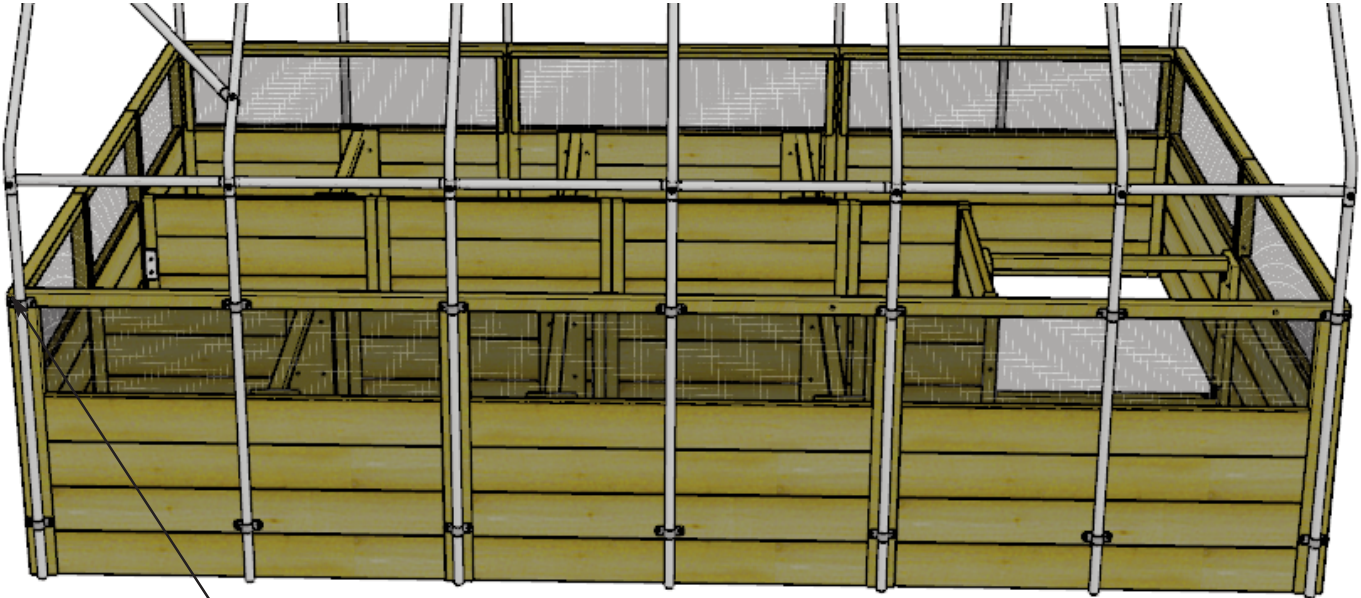

Note: Pre-drill pilot holes to prevent splitting.

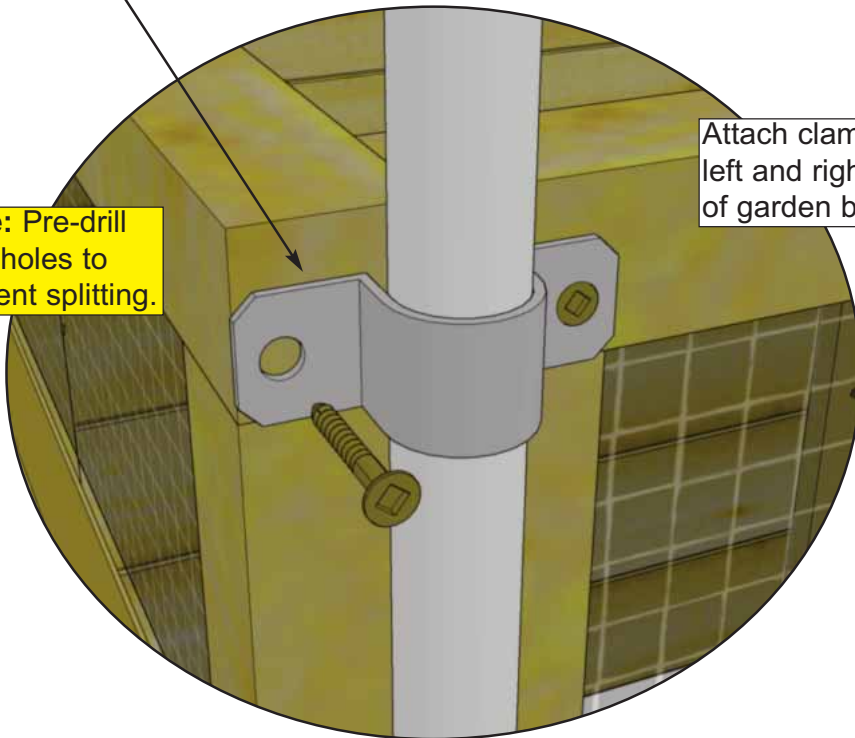

Attach clamps on left and right side of garden bed.

Step

11

Parts & Hardware



2x Protective Stripping Rolls

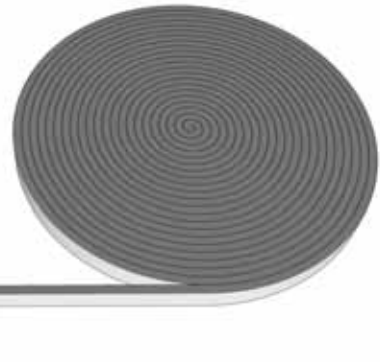

Peel off film to reveal adhesive side of protective stripping. Cover top of Greenhouse Frame with protective stripping as shown below. Start at the bottom of **Part 6** as shown. Protective stripping will prevent your frame from damaging the cover.

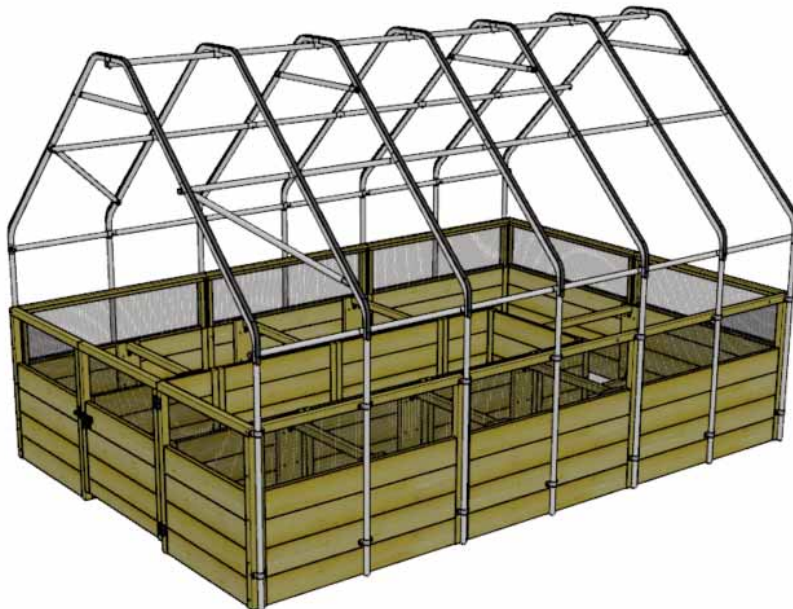
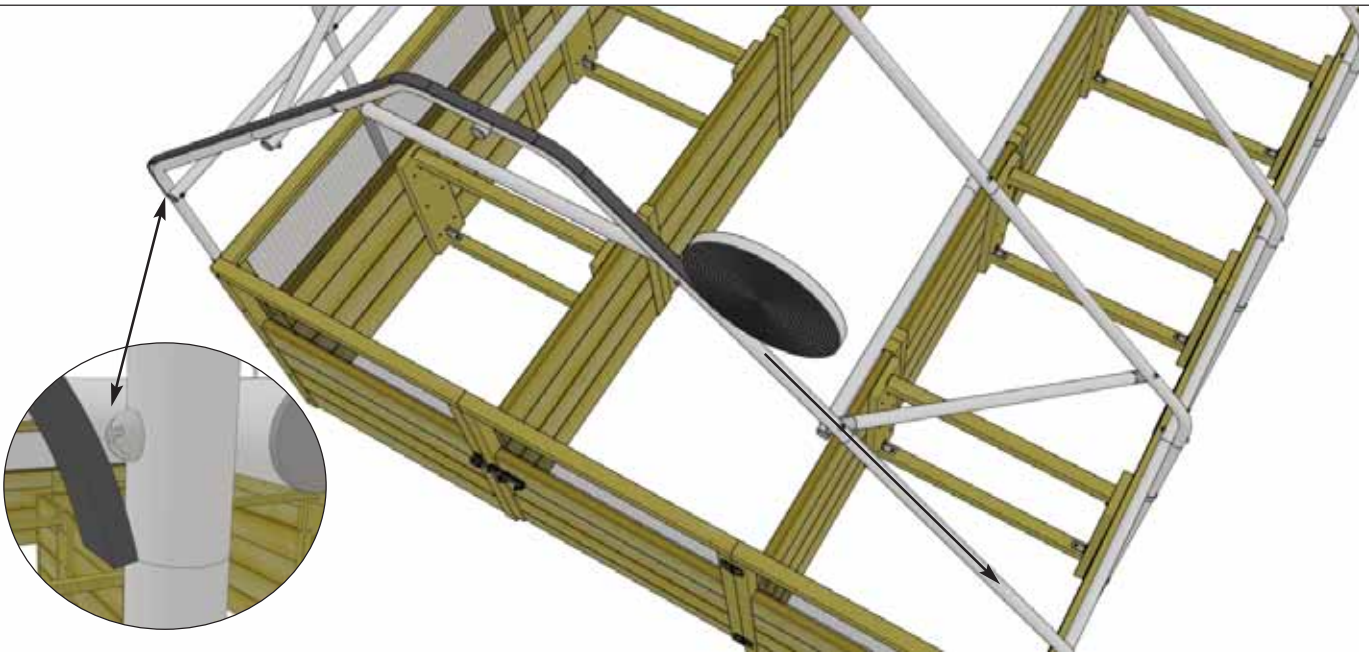

Step 12

Note: To fit the Greenhouse Cover on the frame, you will need to open the doorway of the cover.

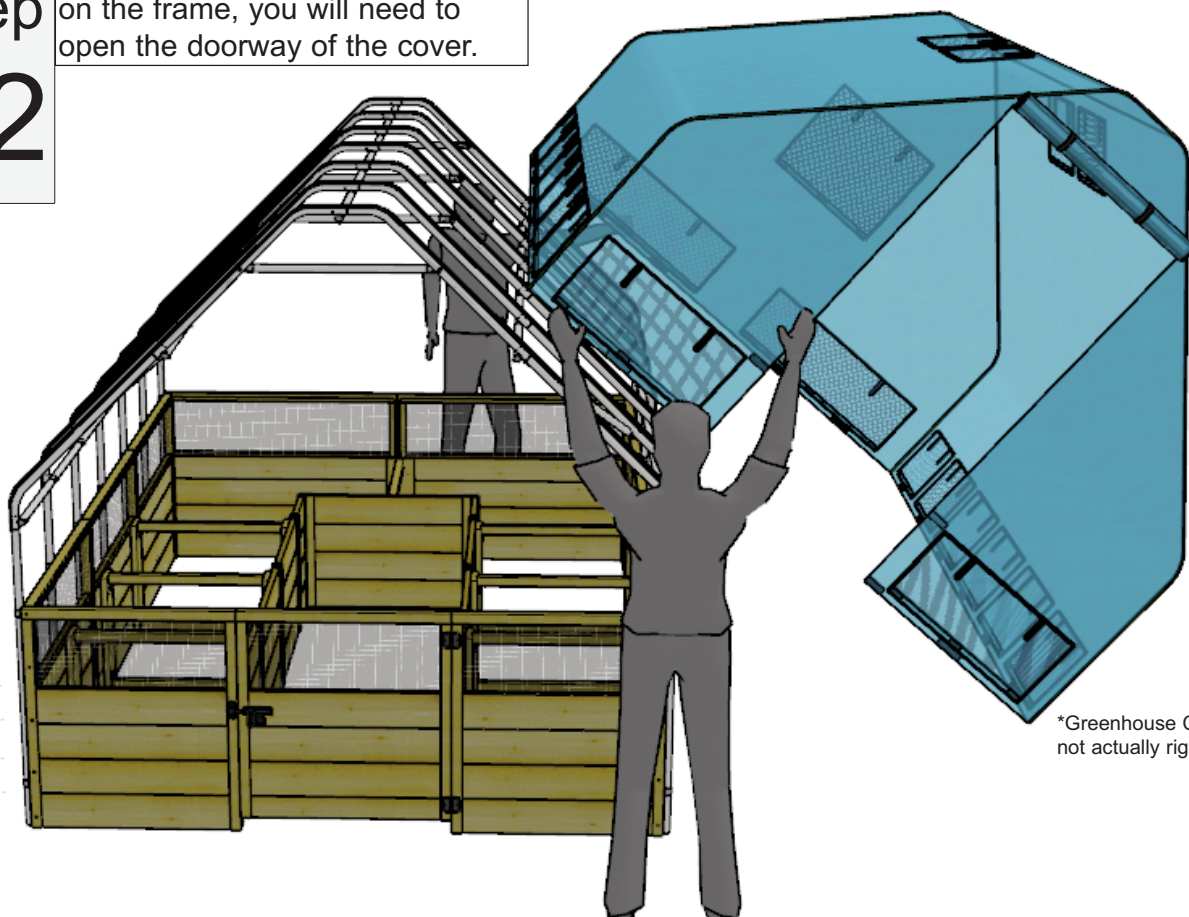

*Greenhouse Cover is not actually rigid.

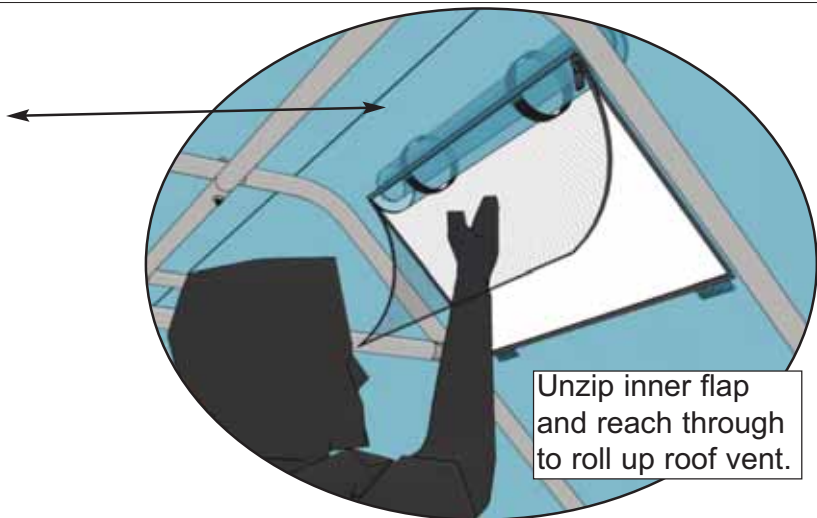

Unzip inner flap and reach through to roll up roof vent.

You may need a step ladder to reach the roof vents.



Step
13

Parts & Hardware

2 x Clips

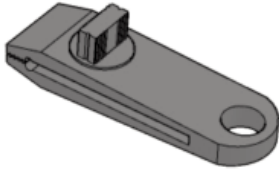

2 x 1 1/4" Pan Head Screws



2 x Washers

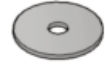

Front of Unit

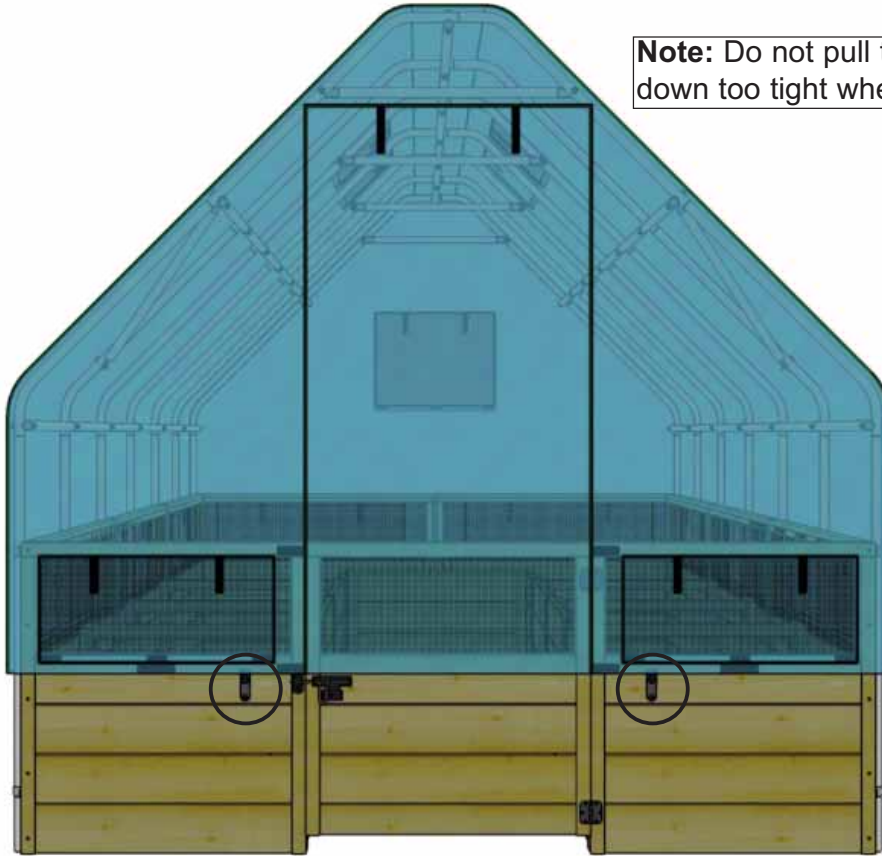

Note: Do not pull the Greenhouse Cover down too tight when attaching the clips.

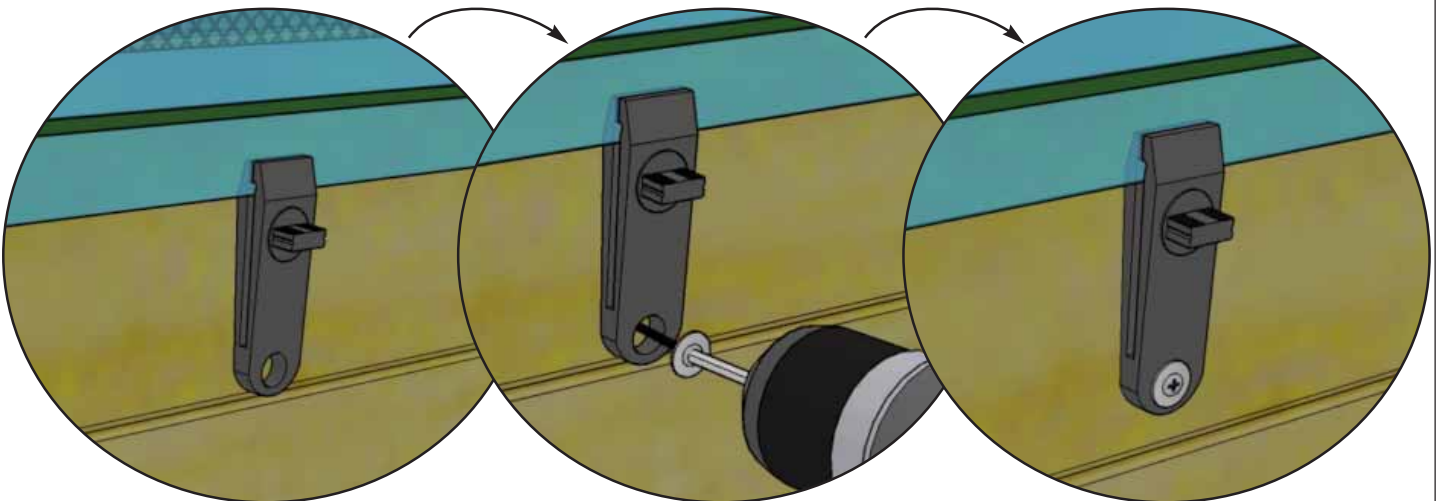

Step
14

Parts & Hardware

14 x Clips

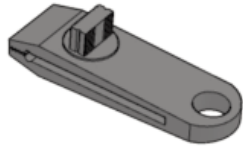

14 x 1 1/4" Pan Head Screws



14 x Washers

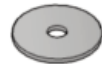

Right Side of Unit



Left Side of Unit



Rear of Unit

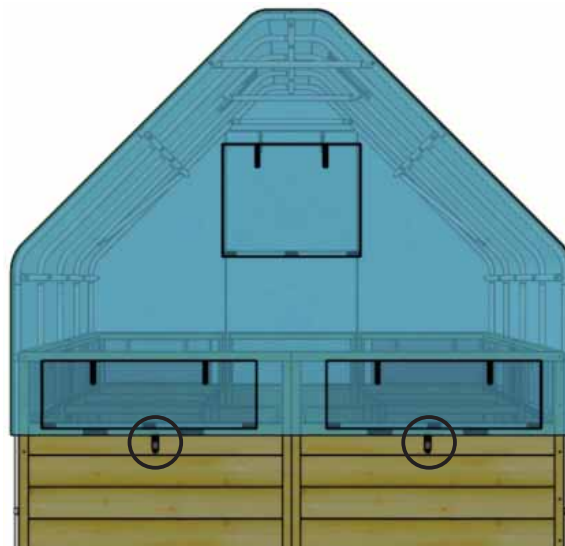

Made with North American Western Red Cedar

www.CedarShedAndGardenKits.com info@CedarShedAndGardenKits.com

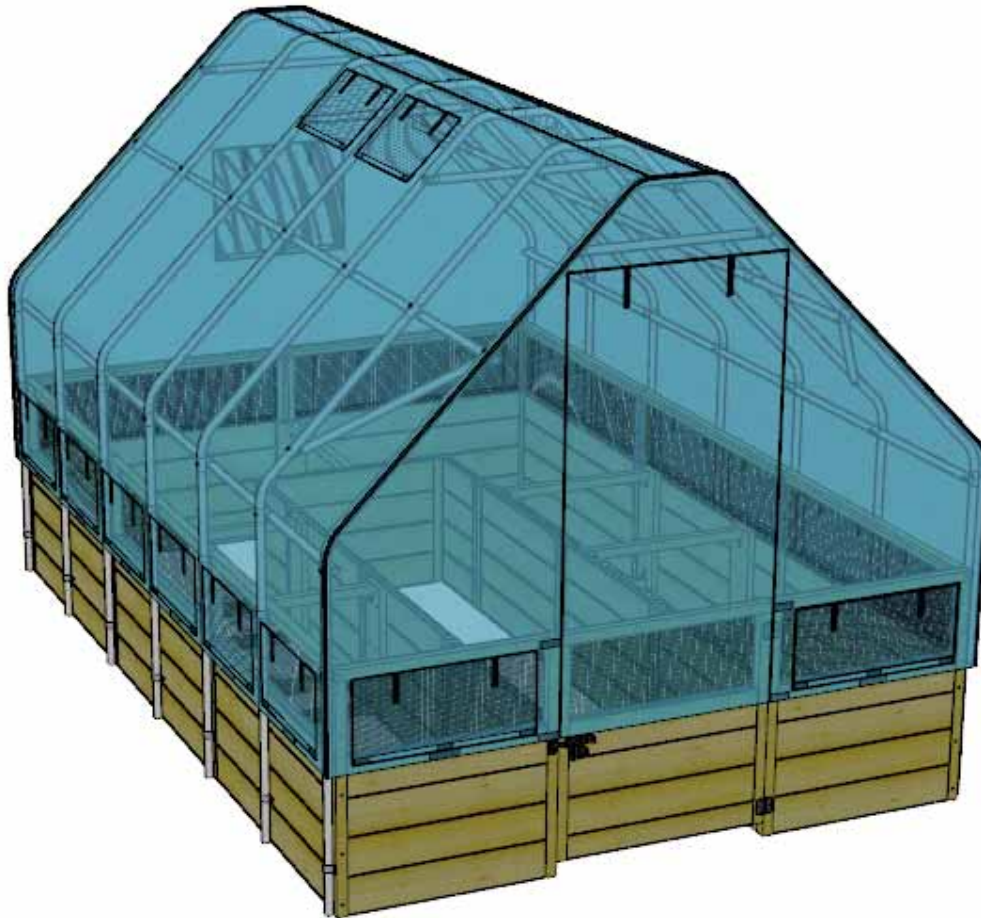

We value your feedback and would like to hear back from you on how well we are doing in the following areas:

1. **Customer Service**
2. **On Time Shipping**
3. **Motor Freight Delivery**
4. **Quality of Materials**
5. **Assembly Manual**
6. **Overall Satisfaction.**

Please email John and Pat Motley
info@CedarShedandGardenKits.com

The materials contained in this Assembly Manual may be downloaded or copied provided that ALL copies retain the copyright and any other proprietary notices contained on the materials. No material may be modified, edited or taken out of context such that its use creates a false or misleading statement or impression as to the positions, statements or actions.