

# Cedar

---

## Shed & Garden Kits

# 8'X8' Garden in a Box with Greenhouse Cover Assembly Manual

**Made with North American Western Red Cedar**

[www.CedarShedAndGardenKits.com](http://www.CedarShedAndGardenKits.com)

[info@CedarShedAndGardenKits.com](mailto:info@CedarShedAndGardenKits.com)

**Free Delivery from the  
Factory to your Home,  
Ranch or Business**

**Thanks for your interest  
in the 8x8 Garden Box  
Greenhouse**

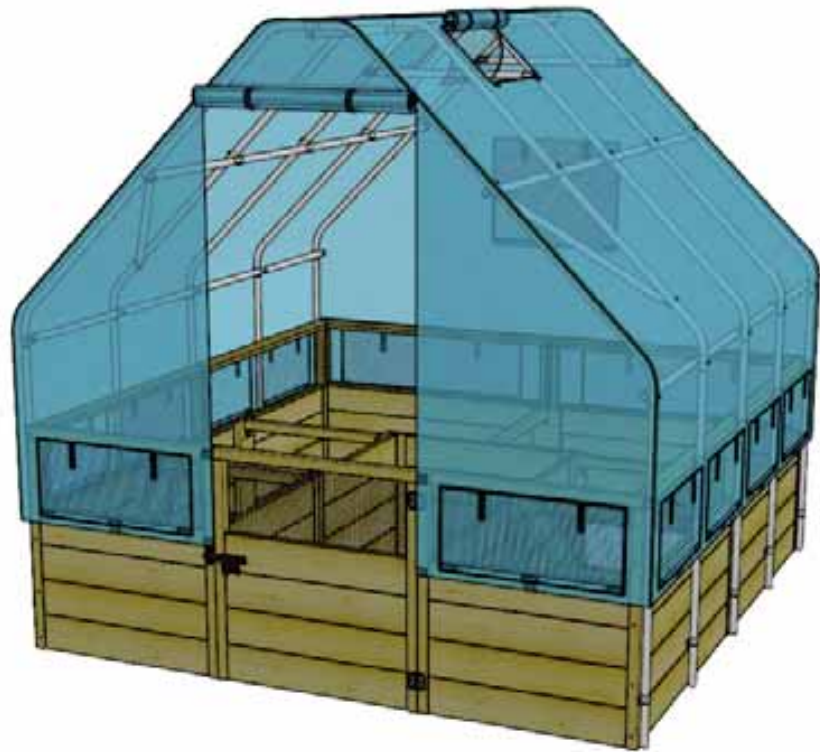

In colder climates, please remove your Garden in a Box Plastic Cover during the winter months and store in included bag in a dry warm location.

Do not leave cover on during any large snow storms or extreme weather phenomenon such as hurricanes, tornadoes or heavy wind storms.

Cover can easily be taken off in minutes if such weather patterns are forecast in your area.

We recommend once a year in the early spring to check that all fasteners are snug and to tighten if loose.

Plastic cover can be cleaned with a mild soap and a cloth.

Customer agrees to hold OLT Manufacturing and Cedar Shed and Garden Kits LLC, Authorized Dealer, free of any liability for improper installation, maintenance and repair.

### Garden in a Box Dimensions:











- A: Height = 33 1/2"
- B: Outside Width = 92"
- C: Outside Depth = 95"
- D: Height to Bottom of Screen = 21 1/2"
- E: Door Width = 30 5/8"
- F: Length of Inner Panel Sections = 62 3/4"

***n the event of missing or broken pieces, please call the Customer Support Line within 30 days of the delivery of your kit. You'll find the number in your Assembly Manual that comes with the kit. It is our commitment to you to deliver replacement parts, free of charge, within 10 business days of your notification. Replacement parts will not be provided free of charge after the 30 day grace period. All structures Manufactured by OLT are covered for a period of one year for defects in manufacturing and workmanship. Costs incurred for customer installations are not included. Failure to use supplied parts included in this kit could result in poor product performance and may void your warranty.***

*Cedar Shed and Garden Kits LLC is an Authorized Dealer of OLT Manufacturing*

*OLT reserves complete title and full intellectual property and copyright rights in any and all content within*

Thank you for purchasing our 8x8 Garden in a Box with Greenhouse Cover. Please take the time to identify all the parts prior to assembly.

<b>Part 1</b>		<b>x 10</b>
<b>Part 2</b>		<b>x 5</b>
<b>Part 3</b>		<b>x 10</b>
<b>Part 4</b>		<b>x 5</b>
<b>Part 5</b>		<b>x 5</b>
<b>Part 6</b>		<b>x 8</b>
<b>Part 7</b>		<b>x 2</b>
<b>Part 8</b>		<b>x 2</b>
<b>Part 9</b>		<b>x 3</b>
<b>Part 10</b>		<b>x 2</b>
<b>Part 11</b>		<b>x 3</b>

**Hardware & Miscellaneous**

2 x Protective Stripping Rolls (30ft each) 1 x BR1 - Square Drive Bit

44 x S2 - 1 1/4" Screws



2 x M6x60



23 x M6x55



8 x M6x35



20 x Pipe Clamps



12 x Washers

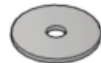

12 x 1 1/4" Pan Head Screws



Greenhouse Cover



Storage Bag



12 x Clips

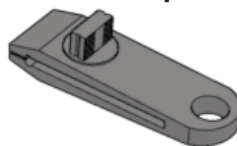

**Tools Required**

(Not Provided)



Screw Gun/Drill



Pliers



Phillips Screwdriver

# Exploded View

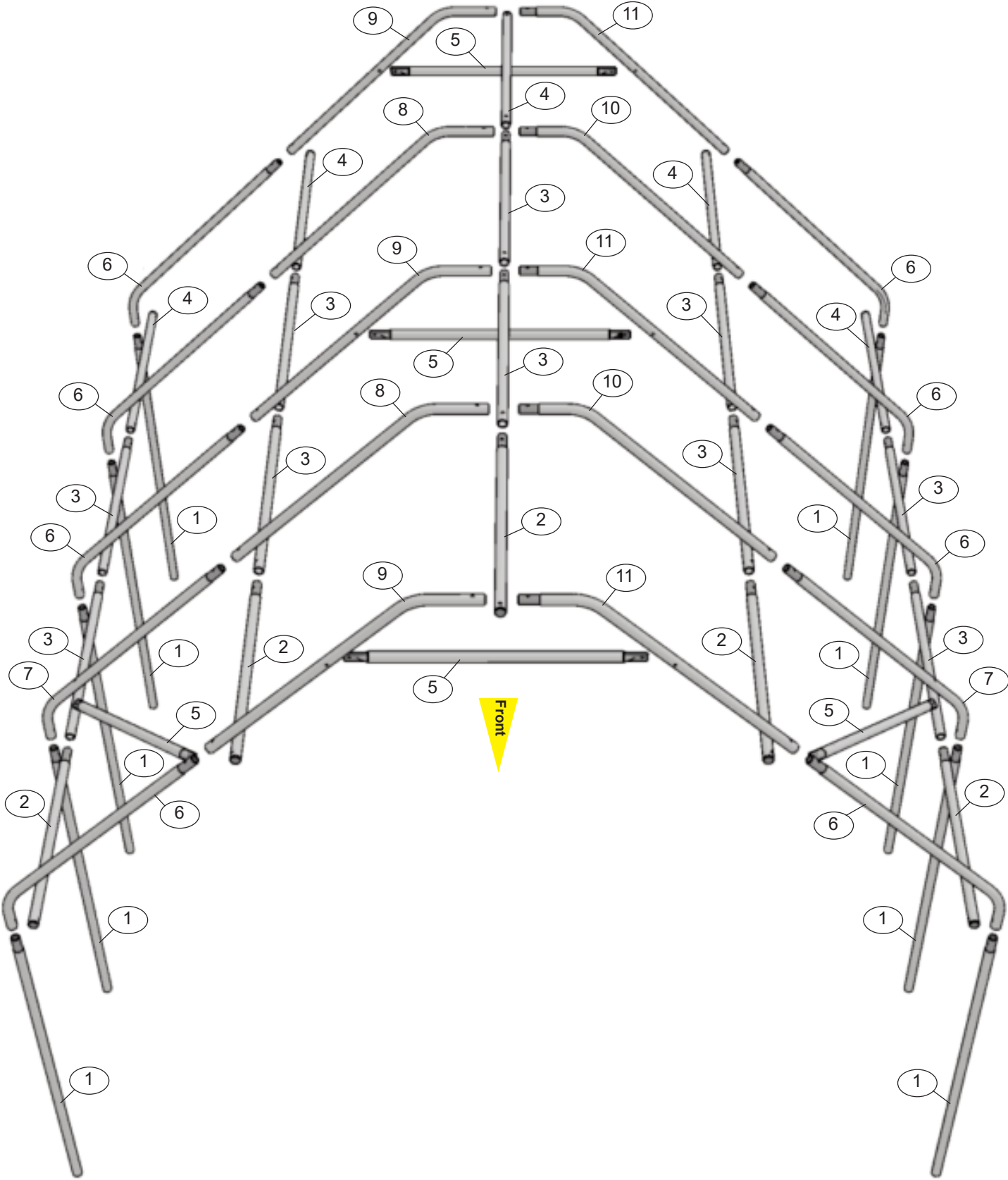

Step  
**1**

Parts & Hardware

1 x Part 4



1 x Part 9



1 x Part 11



1 x M6x55

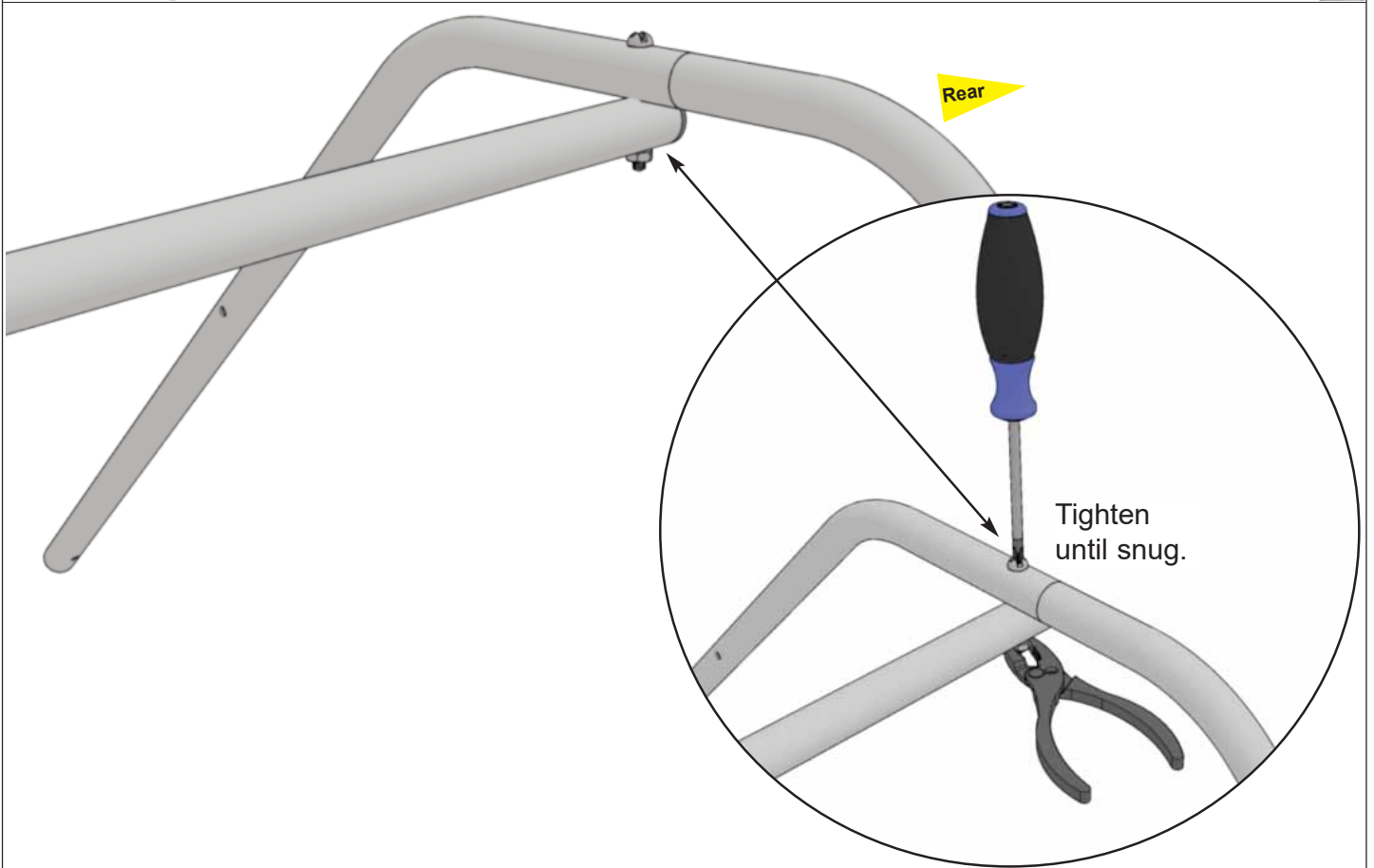
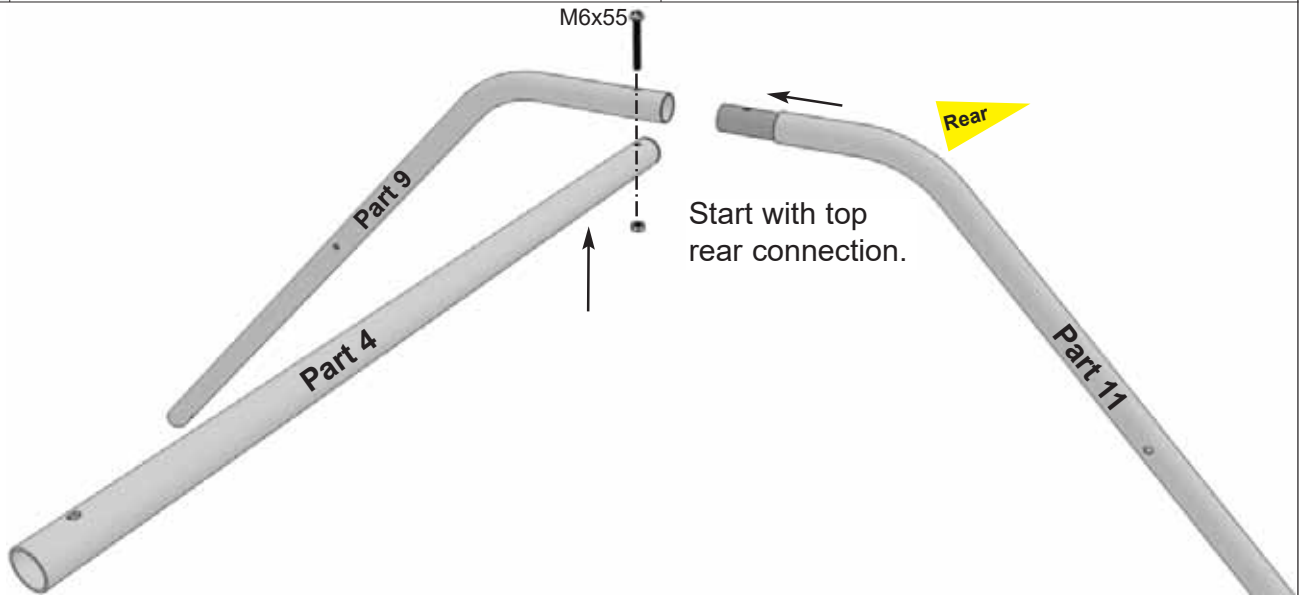

Step

2

Parts & Hardware

1 x Part 5



2 x M6x35

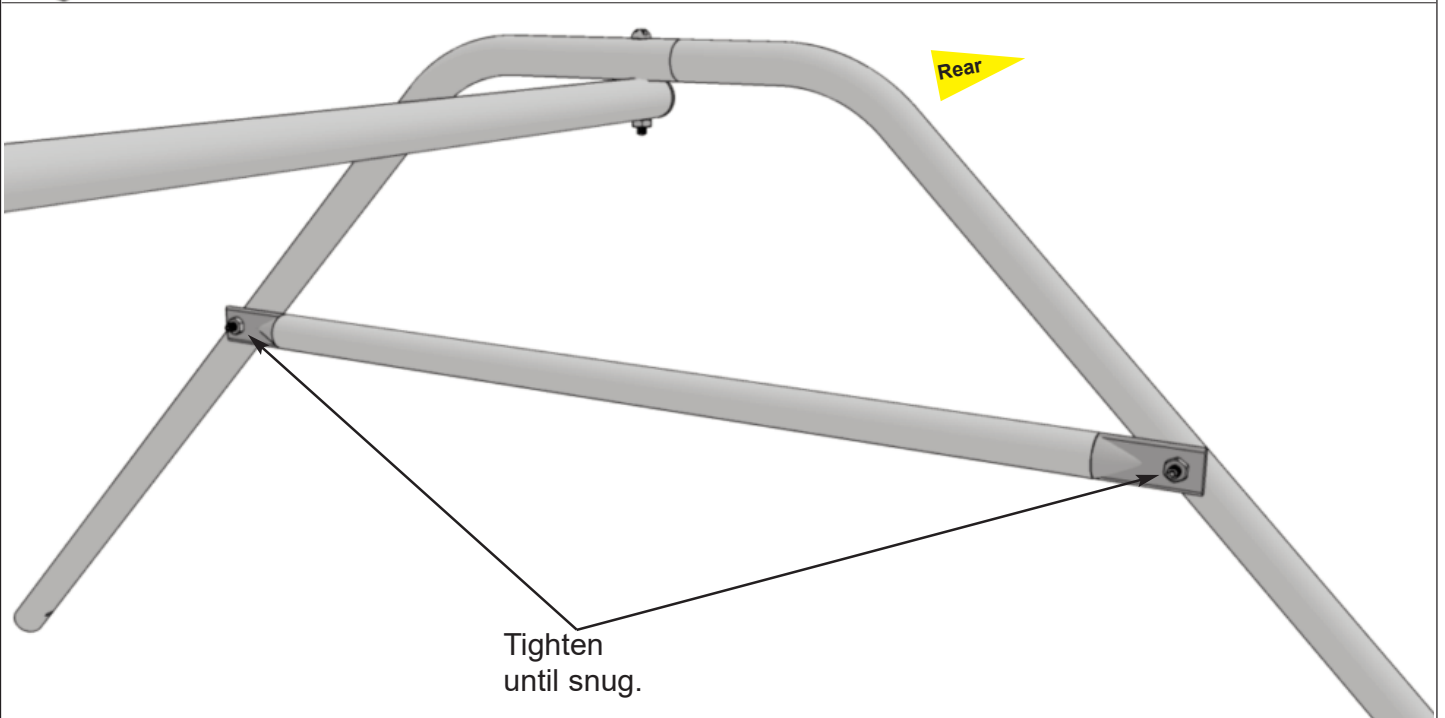
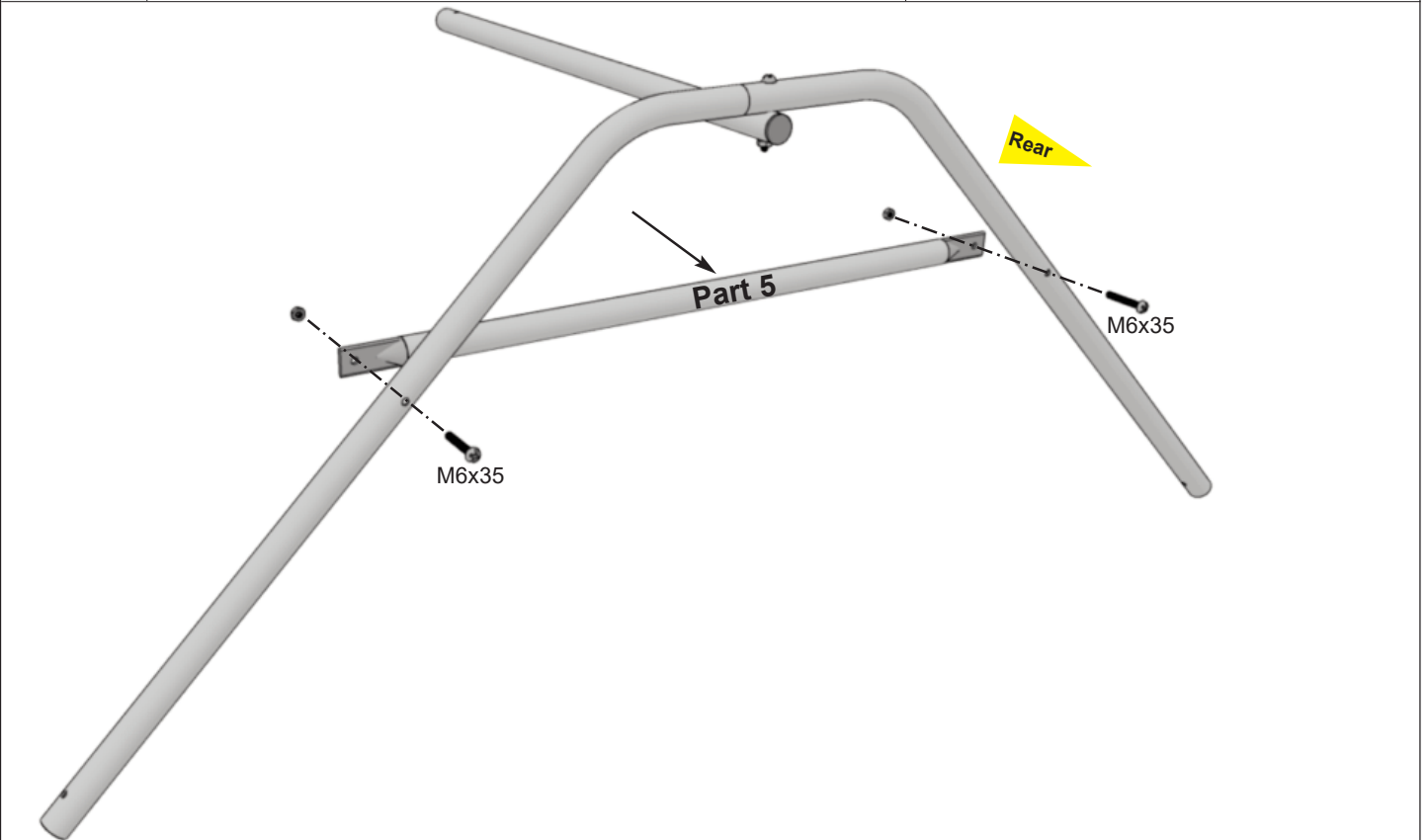

Step <b>3</b>	Parts & Hardware	
	1 x Part 3	1 x Part 10
	1 x Part 8	1 x M6x55

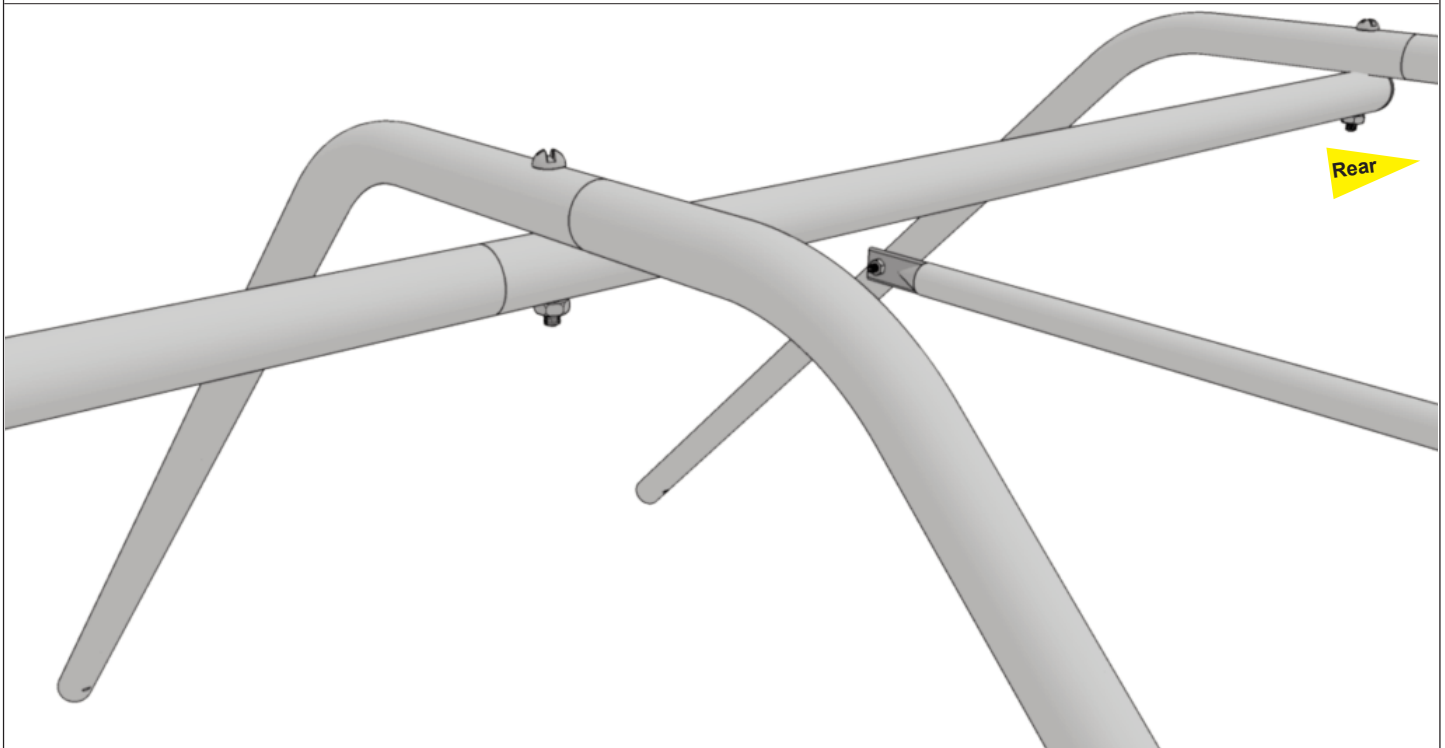
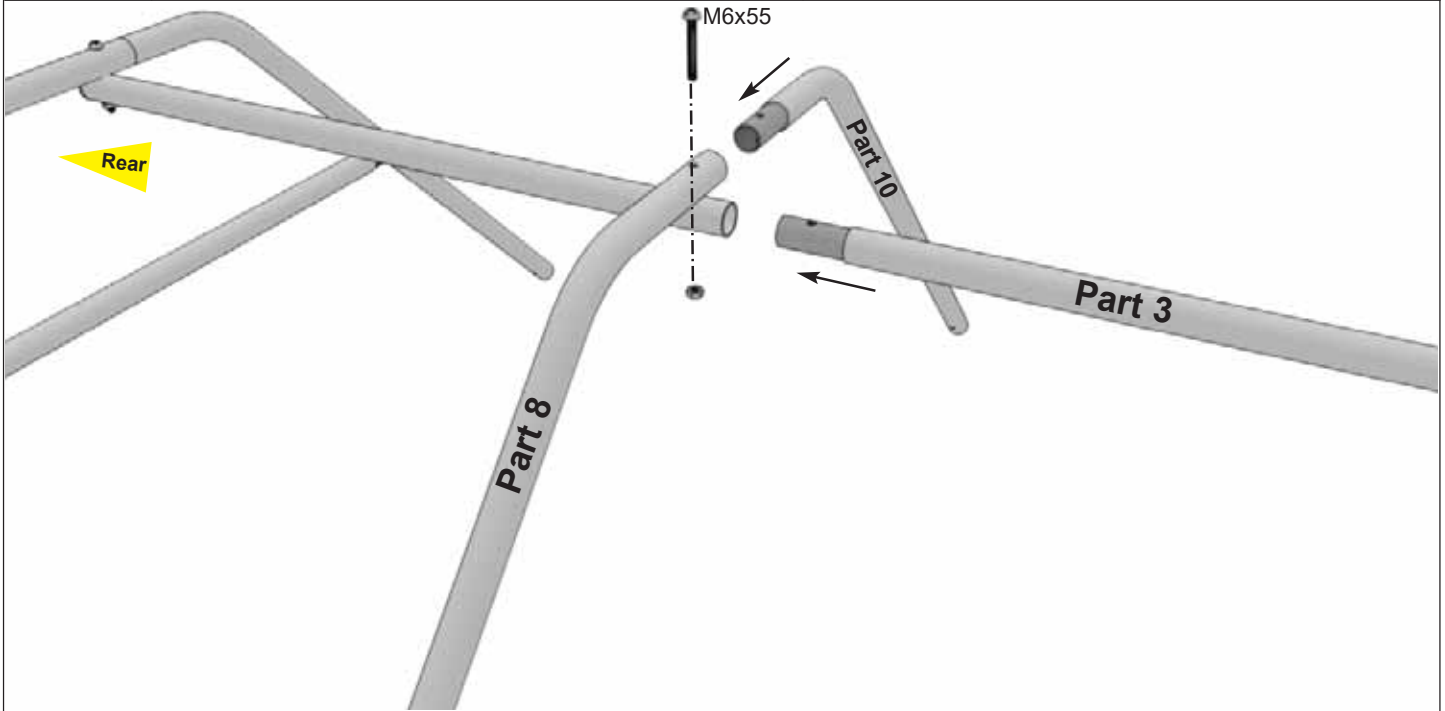

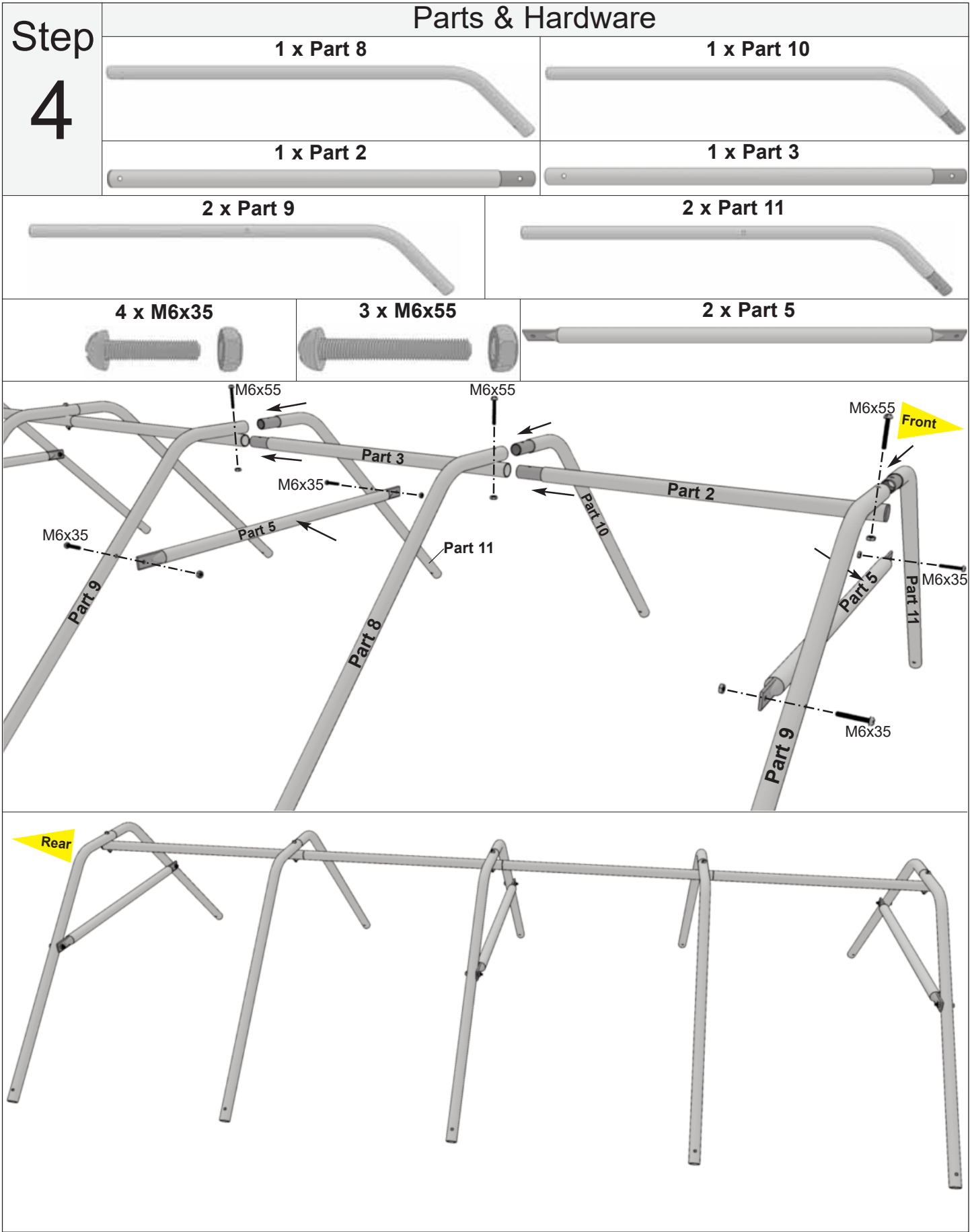

Step	Parts & Hardware		
	5	1 x Part 7	4 x Part 6
1 x Part 4		1 x Part 3	
1 x Part 2		2 x Part 5	
1 x M6x35		4 x M6x55	1 x M6x60



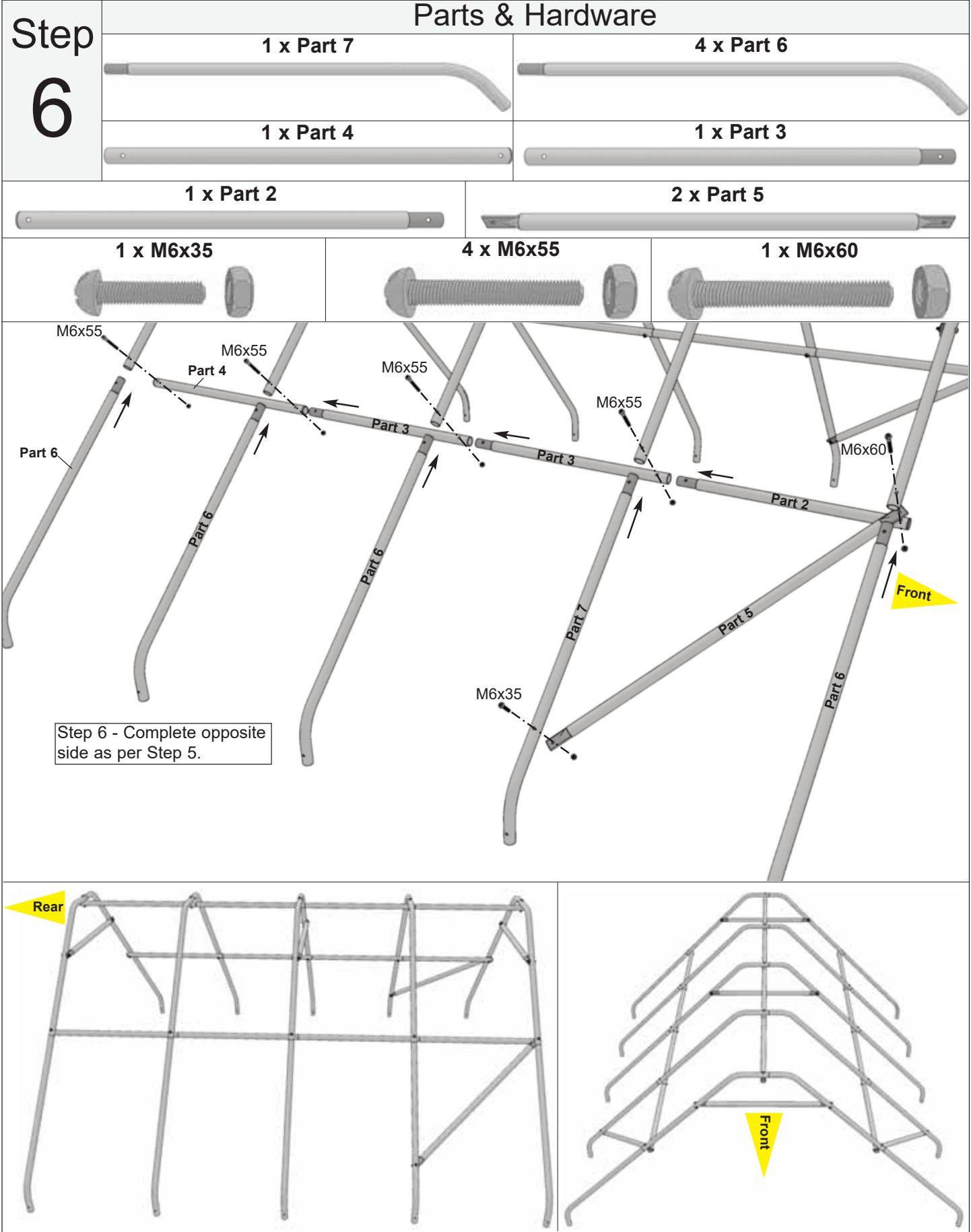

Step

7

Parts & Hardware

2 x Part 2

2 x Part 4

4 x Part 1

4 x M6x55

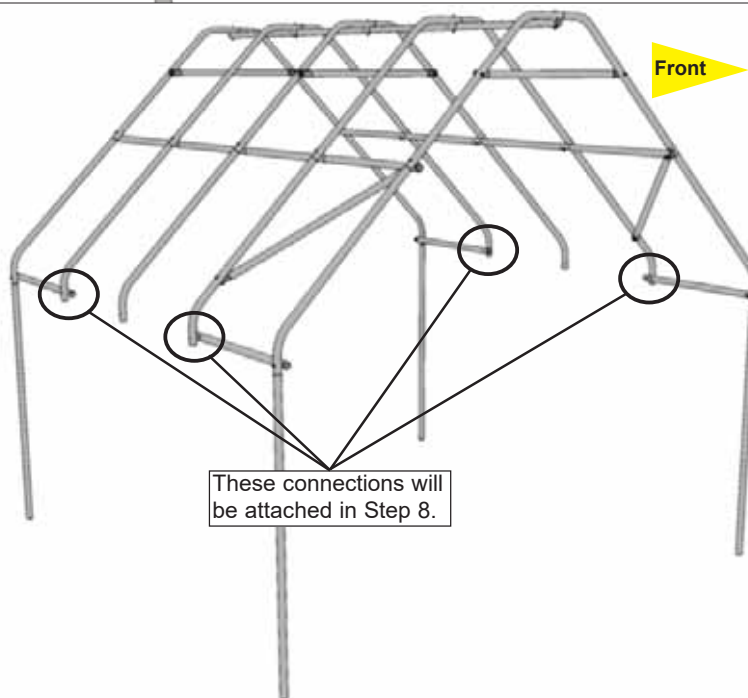
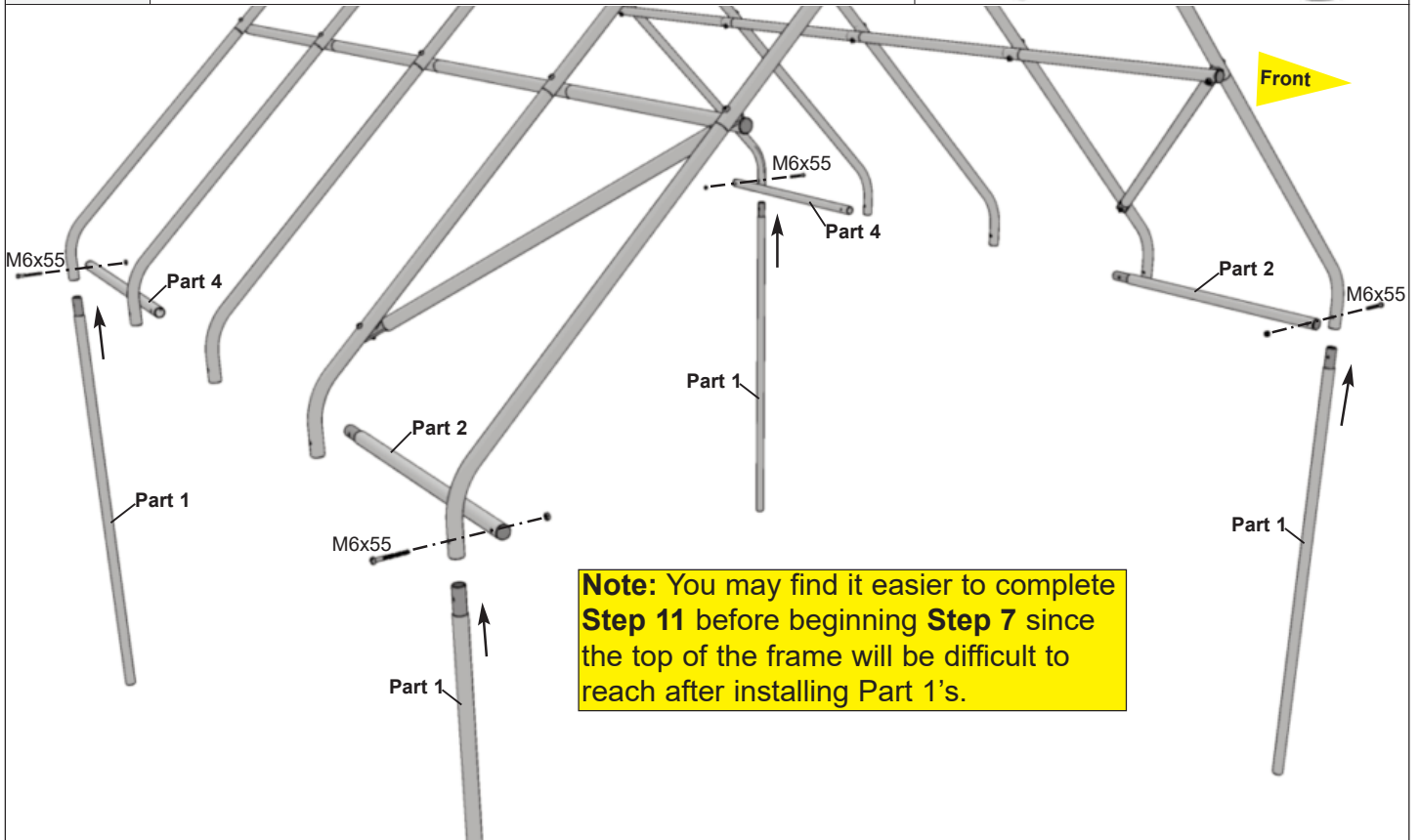

Step  
8

Parts & Hardware

4 x Part 3



6 x M6x55



6 x Part 1

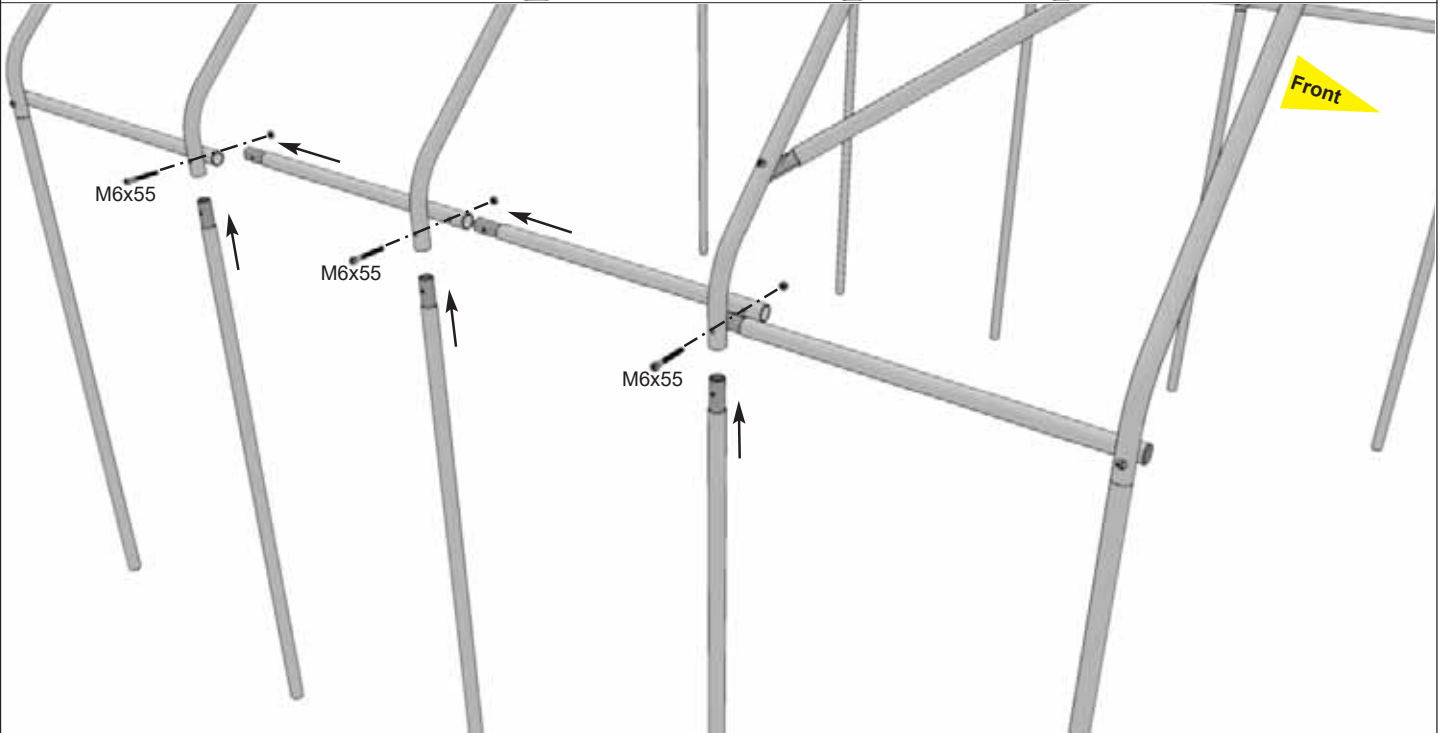
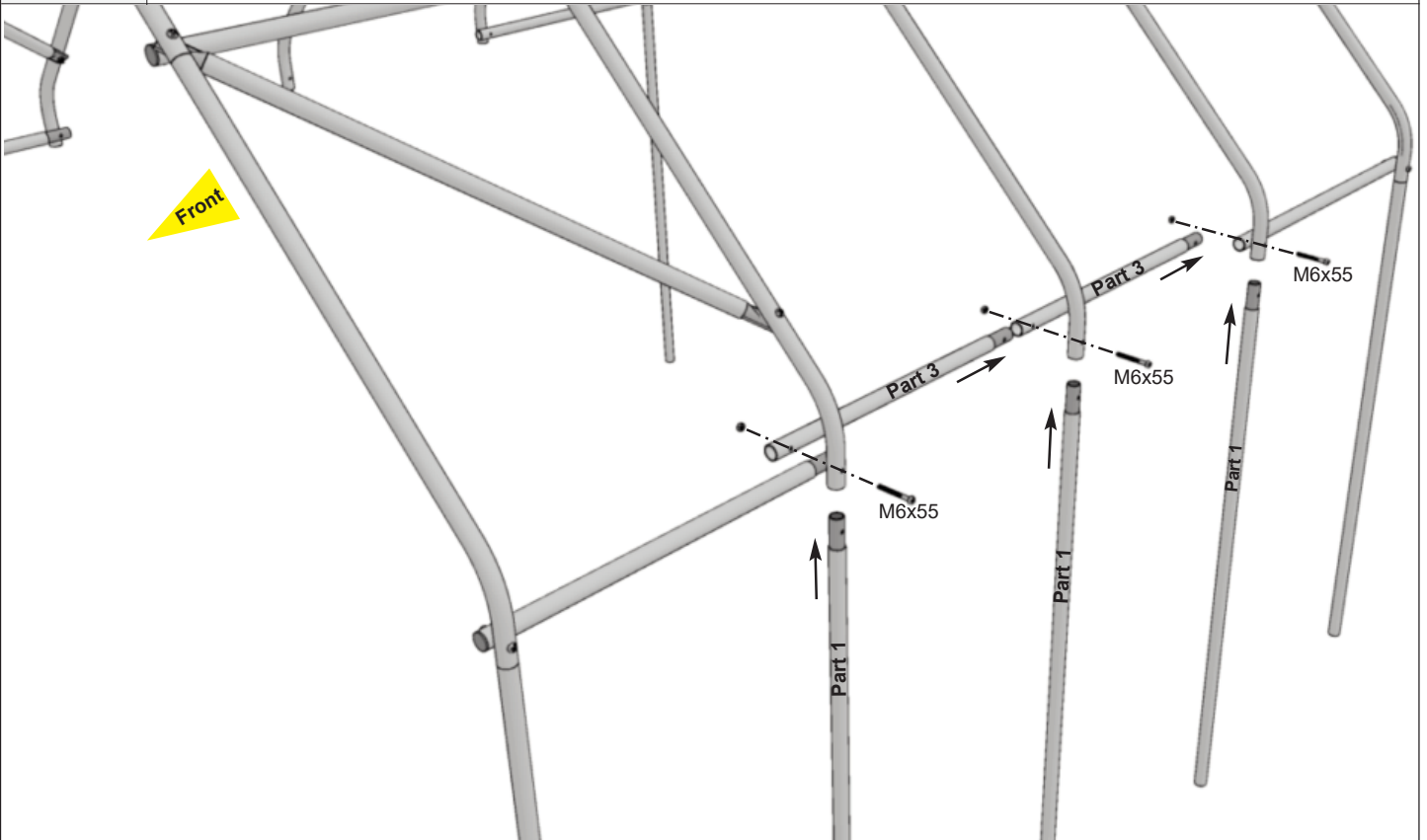

# Step 9

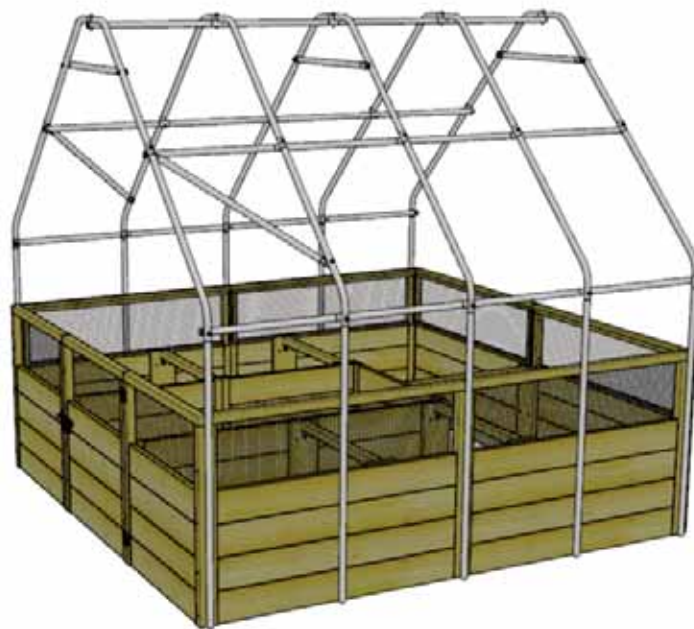
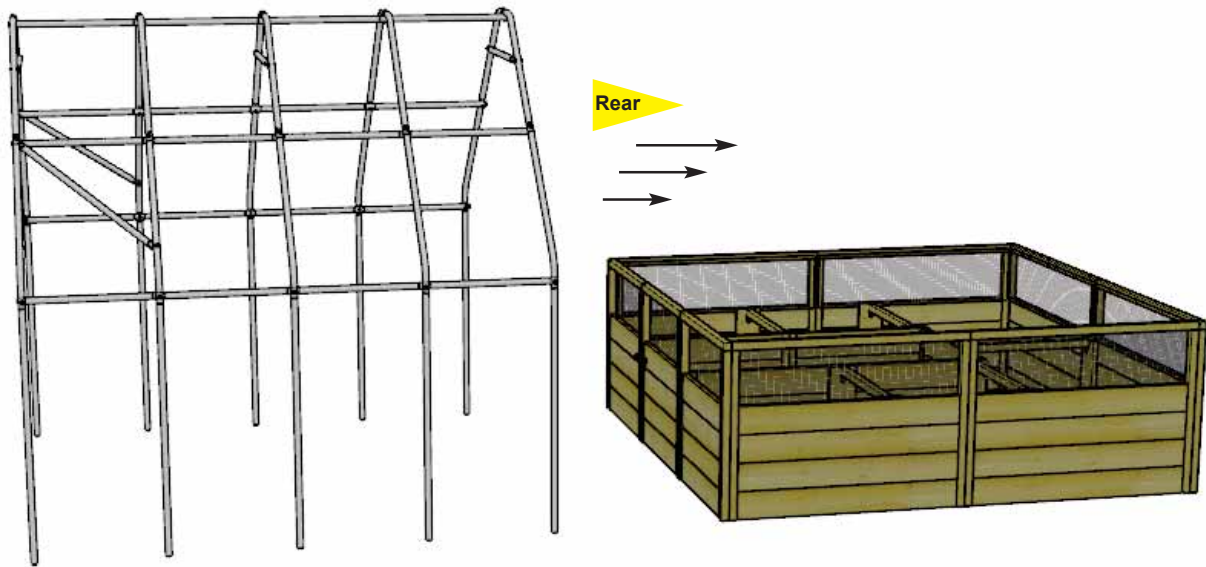

Step  
10

Parts & Hardware

20 x Pipe Clamps



40 x S2 - 1 1/4" Screws

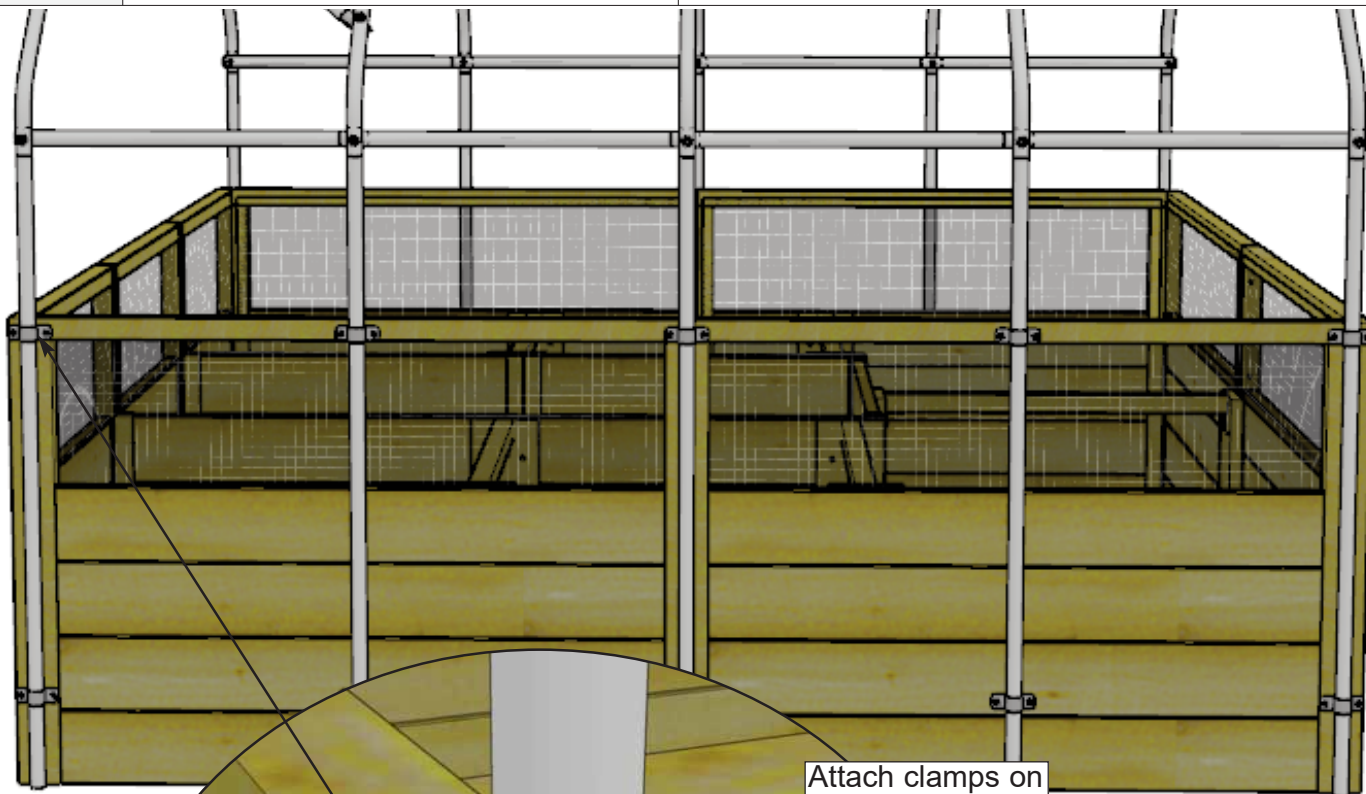

**Note:** Pre-drill pilot holes to prevent splitting.

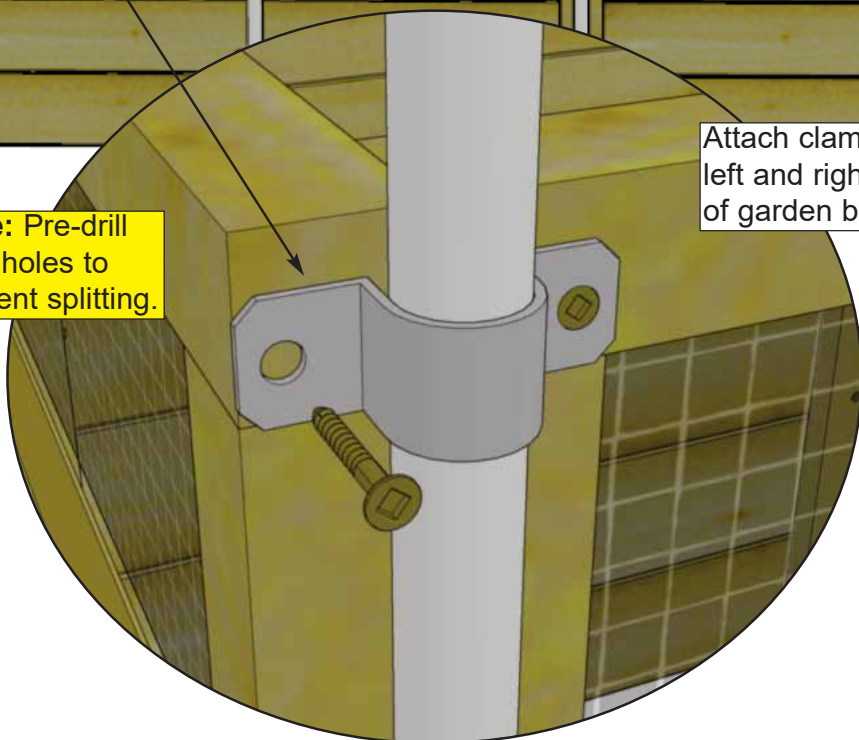

Attach clamps on left and right side of garden bed.

# Step

# 11

## Parts & Hardware



2x Protective Stripping Rolls

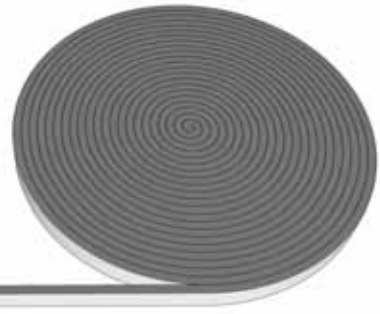

Peel off film to reveal adhesive side of protective stripping. Cover top of Greenhouse Frame with protective stripping as shown below. Start at the bottom of **Part 6** as shown. Protective stripping will prevent your frame from damaging the cover.

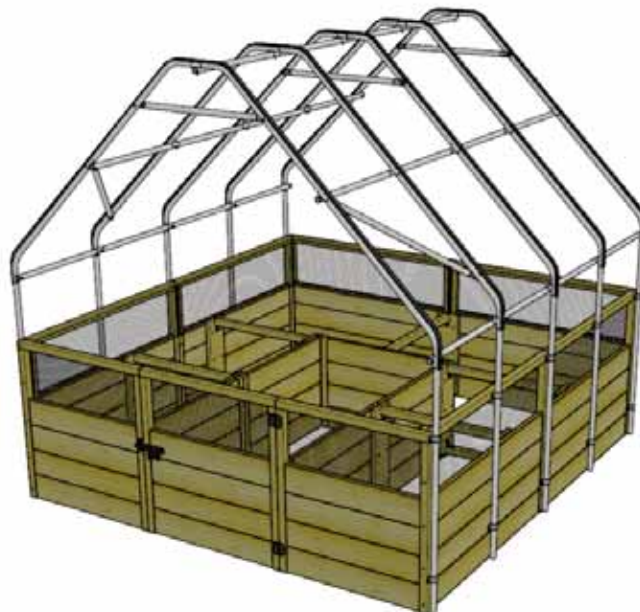
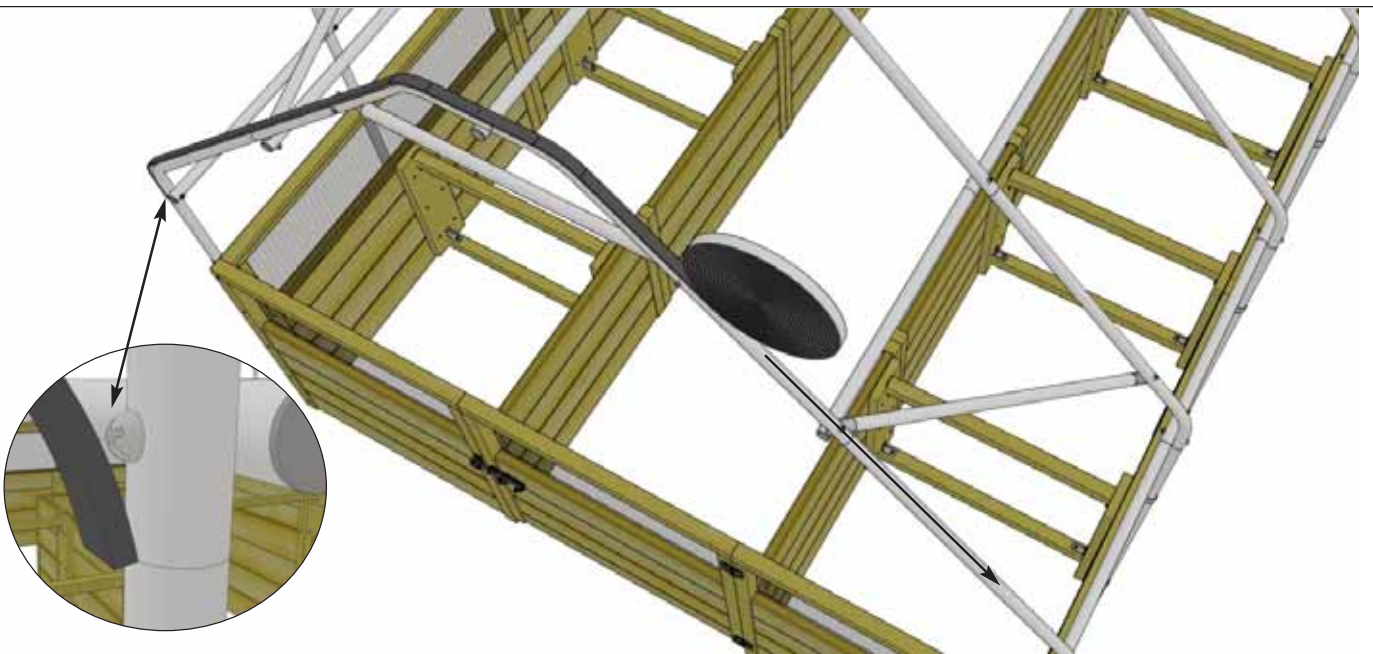

# Step 12

Note: To fit the Greenhouse Cover on the frame, you will need to open the doorway of the cover.

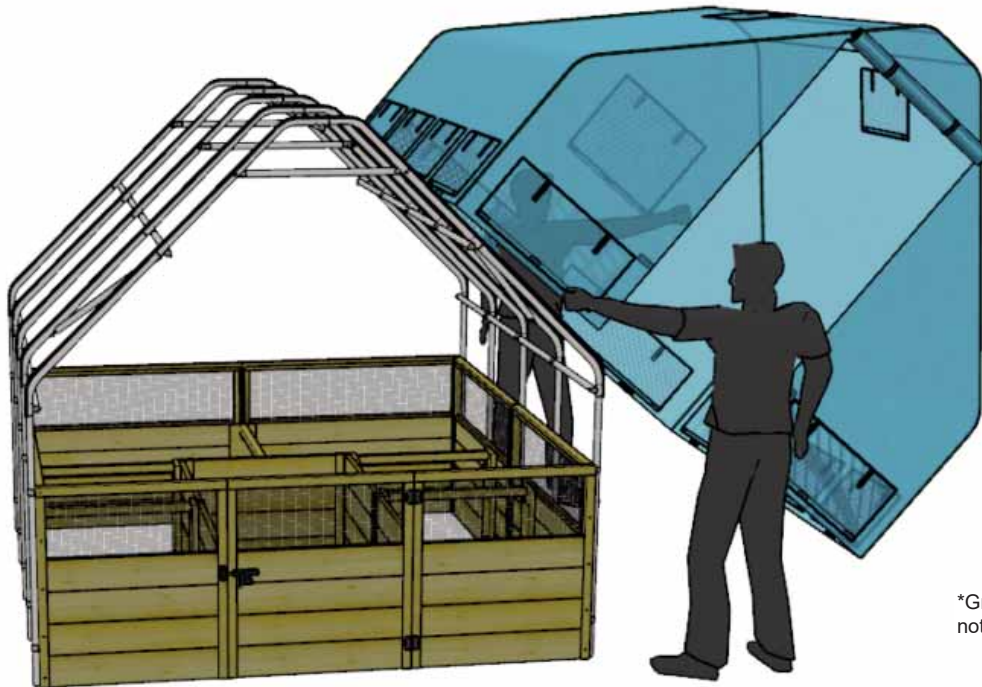

\*Greenhouse Cover is not actually rigid.

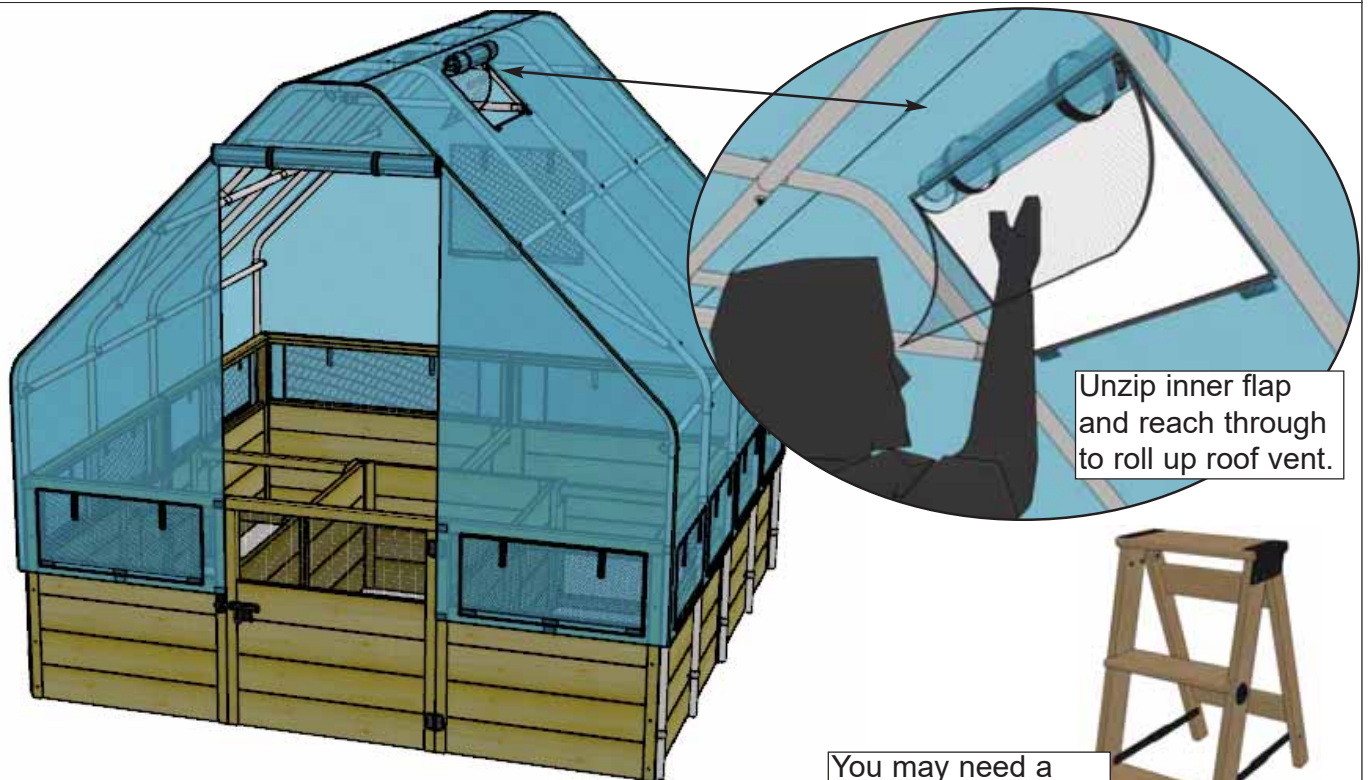

Unzip inner flap and reach through to roll up roof vent.

You may need a step ladder to reach the roof vents.



# Step 13

## Parts & Hardware

2 x Clips

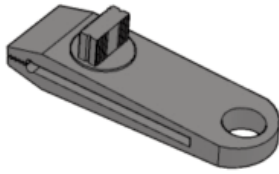

2 x 1 1/4" Pan Head Screws



2 x Washers

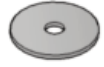

### Front of Unit

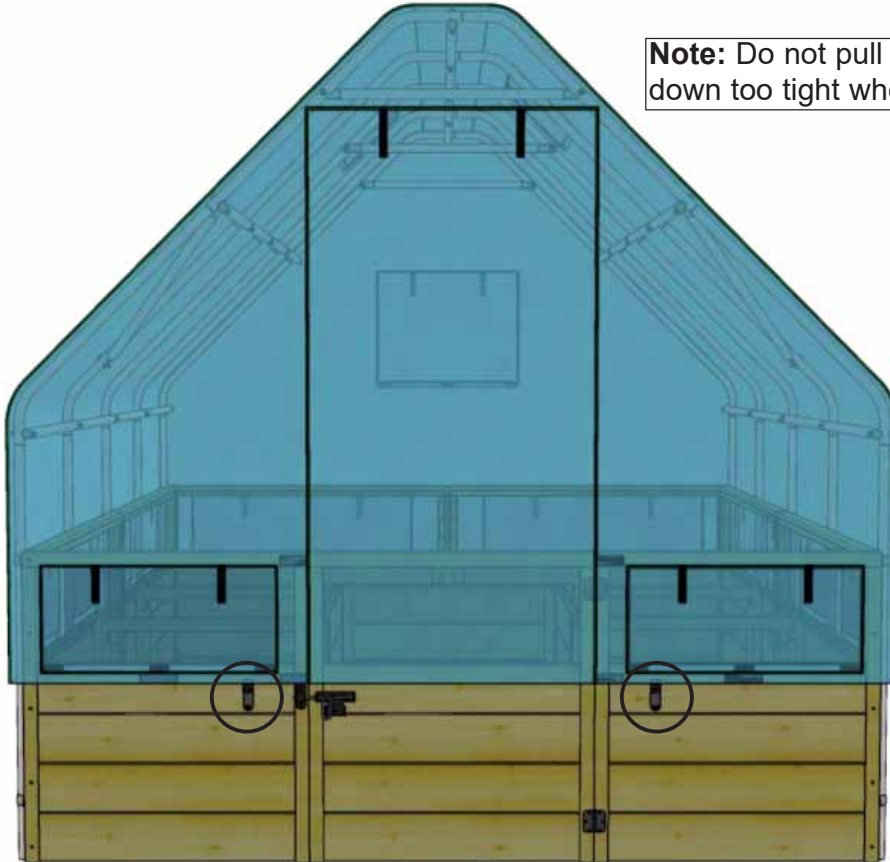

**Note:** Do not pull the Greenhouse Cover down too tight when attaching the clips.

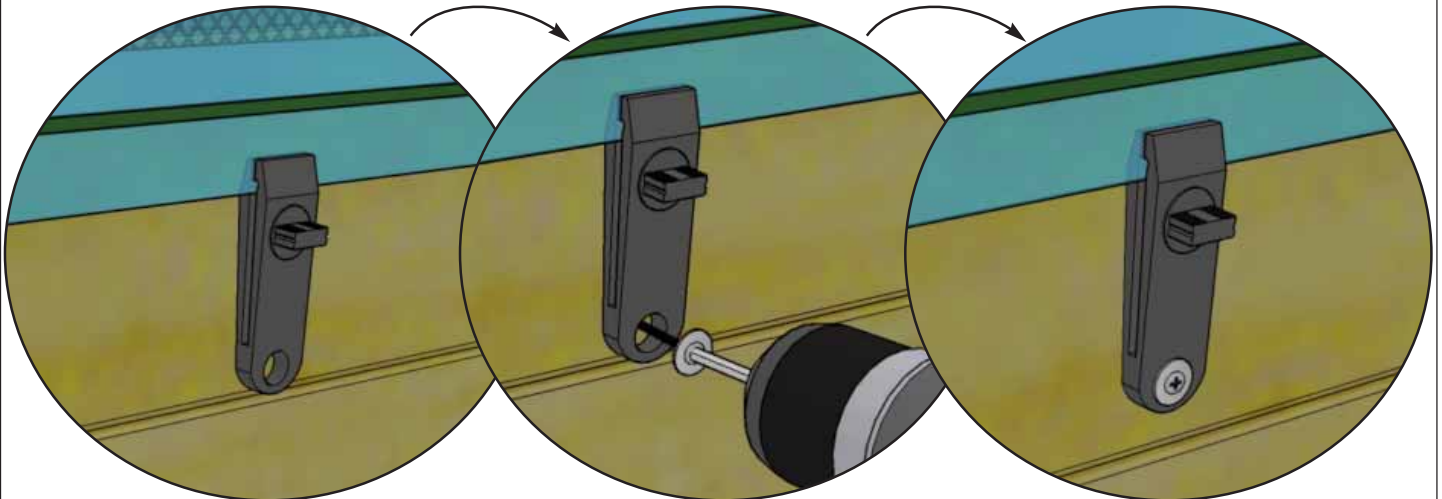



# Step 14

## Parts & Hardware

10 x Clips

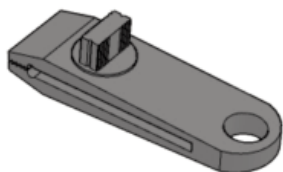

10 x 1 1/4" Pan Head Screws



10 x Washers



Right Side of Unit

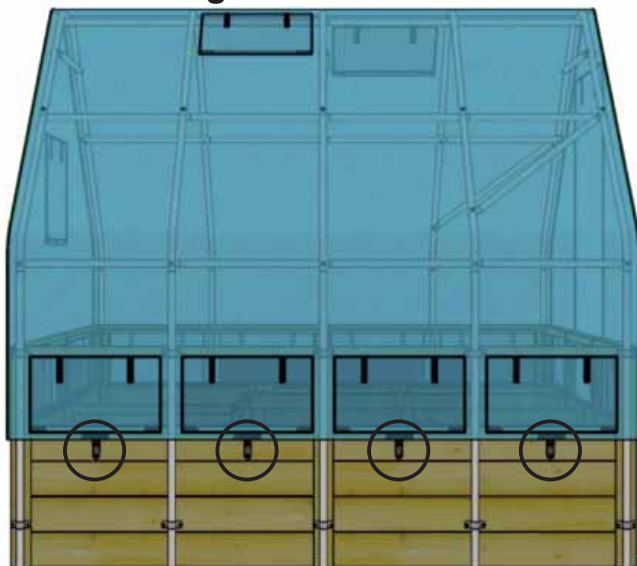

Left Side of Unit

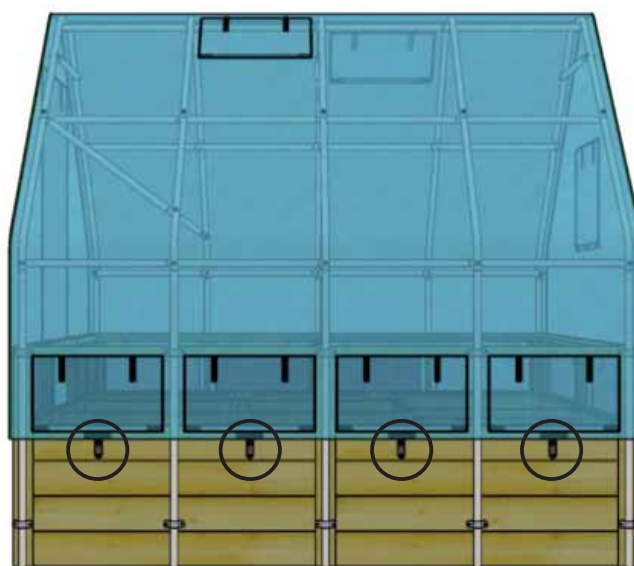

Rear of Unit

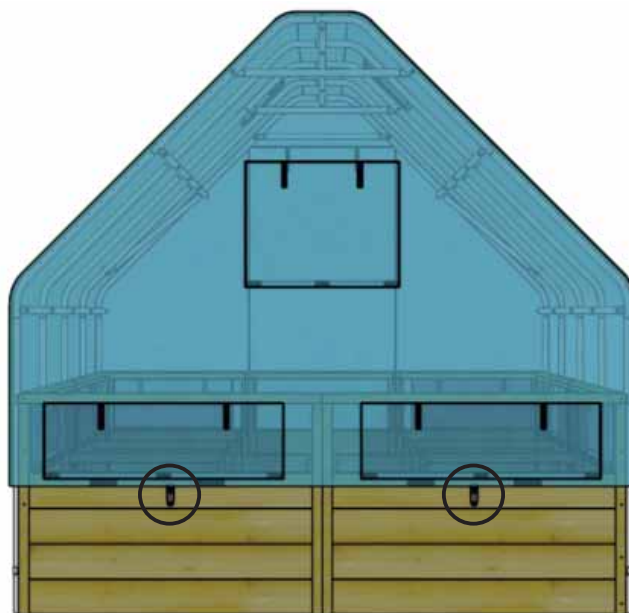

# 8'X8' Garden in a Box with Greenhouse Cover Assembly Manual

**Made with North American Western Red Cedar**

[www.CedarShedAndGardenKits.com](http://www.CedarShedAndGardenKits.com)    [info@CedarShedAndGardenKits.com](mailto:info@CedarShedAndGardenKits.com)

Thanks for your interest in  
the 8x8 Garden in a Box  
with Greenhouse Cover  
*John and Pat*

**Delivery is Free from the  
Factory to your Home,  
Ranch or Business**

Please review this Assembly  
Manual and the Spec Sheet  
thoroughly before ordering. We  
want you to become familiar with  
all of the tools required and where  
and when assistants may be  
necessary. More than anything we  
want this to be fun and successful!



1. Customer Service
2. On Time Shipping
3. Motor Freight Delivery
4. Quality of Materials
5. Assembly Manual
6. Overall Satisfaction.

Please email John and Pat Motley  
[info@CedarShedandGardenKits.com](mailto:info@CedarShedandGardenKits.com)

The materials contained in this Assembly Manual may be downloaded or copied provided that ALL copies retain the copyright and any other proprietary notices contained on the materials. No material may be modified, edited or taken out of context such that its use creates a false or misleading statement or impression as to the positions, statements or actions.