



6x3 Garden Saver with rear sloping Cedar Shingle Roof ASSEMBLY MANUAL

Made with North American Western Red Cedar

www.CedarShedAndGardenKits.com info@CedarShedAndGardenKits.com

**Thanks for your interest in
the 6x3 Garden Saver
Shed ~ John and Pat**

**Delivery is Free from the
Factory to your Home,
Ranch or Business and
Liftgate Delivery is always
included with every order.**

Please review this Assembly Manual and the Spec Sheet thoroughly before ordering. We want you to become familiar with all of the tools required and where and when assistants may be necessary. More than anything we want this to be fun and successful!



- snow load ratings vary by geographical location. If heavy or wet snowfall occurs, it is advisable to sweep the snow off the roof(s).
- if the product is elevated, any structural and building code requirements are solely the customer's responsibility, and should be abided by.
- in high or gusty wind conditions it is advisable to keep the structure securely grounded.
- have a regular maintenance plan to ensure screws, doors, windows and parts are tight.

Customer agrees to hold OLT Manufacturing and Cedar Shed And Garden Kits LLC Authorized Dealer, free of any liability for improper installation, maintenance and repair.

In the event of missing or broken pieces, please call the Customer Support Line within 30 days of the delivery of your kit. You'll find the number in your Assembly Manual that comes with the kit. It is our commitment to you to deliver replacement parts, free of charge, within 10 business days of your notification. Replacement parts will not be provided free of charge after the 30 day grace period.

*Cedar Shed and Garden Kits LLC is an Authorized Dealer of OLT Manufacturing
OLT reserves complete title and full intellectual property and copyright rights in any and all content within*

What to do before my Shed arrives?



- Become familiar with this assembly manual and determine if you can complete the project yourself or will require a professional contractor.



- One helper is recommended to assist in constructing your chalet. It generally takes two people less than a day to assemble a chalet. If you're hiring a contractor, their rate should be in line with that duration of work.



- Clear the construction area and ensure a clear pathway for delivery when the freight company arrives. Remove all debris: roots, grass, rocks, etc.



- Excavate the site. Contact your local utilities company to ensure there are no gas or electric lines buried in the area before digging.



- Decide on the type of foundation you will be using:
 - Concrete slab, or
 - 4-6 inches of crushed gravel with paver stones or 4x4 stringers.

You can find the footprint for your shed on Page 3 of your Assembly Manual.



- If doing the assembly yourself, have all the necessary tools ready to go and in working condition. A list of required tools can be found after the parts list.

Foundation Types for 6x3 Garden Shed

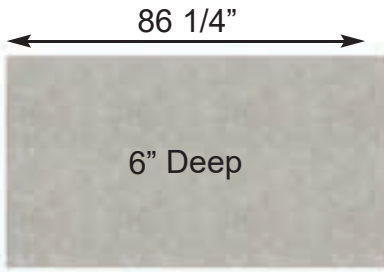

Concrete Foundation

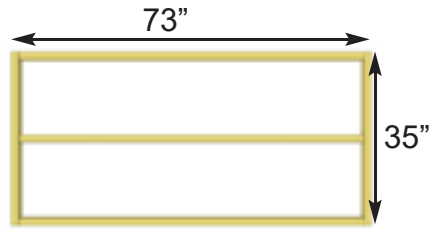

Floor Frame



Completed Foundation

Concrete Slab Foundation:

- Slab must be at least the same size as assembled floor frame (35" x 73") or larger.
- 6" Deep foundation.
- 0.6 Cubic Yards of concrete required.
- A concrete slab will have the longest durability out of your foundation options.

Once level, a concrete slab is the easiest surface to build on.



Gravel Foundation

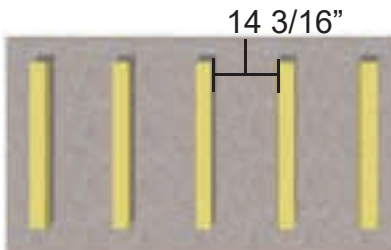

5 - 4"x4"x34 3/4"

Gravel Foundation with treated stringers

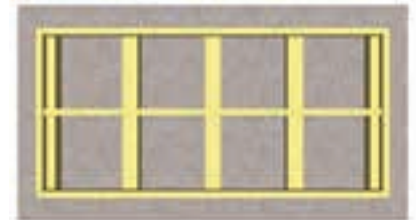

Completed Foundation

Gravel with 4x4 Pressure Treated Stringers:

- Excavate at least 6" deep, and 6" wider than floor frame on each side.
- 0.6 Cubic Yards of gravel required, approximately 6 wheelbarrows.
- 5 - 4x4 Pressure Treated Stringers 34 3/4" long required.
- Evenly spaced, with one at each end of floor frame.

Saves money on materials, easy to level and work with.

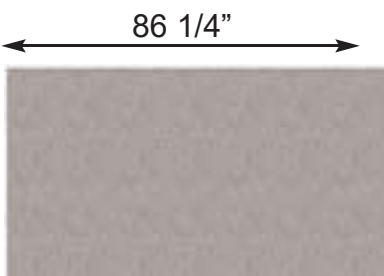

Gravel Foundation

8 Patio Stones



Gravel Foundation with Patio Pavers

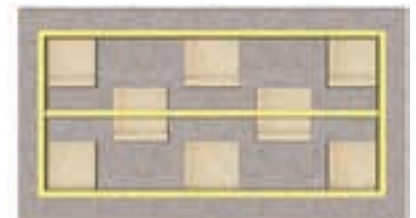

Completed Foundation

Gravel with Patio Paver Stones:

- Excavate at least 6" deep, and 6" wider than floor frame on each side.
- 0.6 Cubic Yards of gravel required, approximately 6 wheelbarrows.
- 8 patio pavers (8" x 8" or larger).
- Center patio paver stones underneath floor runners and underneath seams in floor joists.

Patio paver stones are widely available from most landscape stores.

6x3 GARDEN SAVER - CEDAR ROOF

Hardware Kit (Provided)

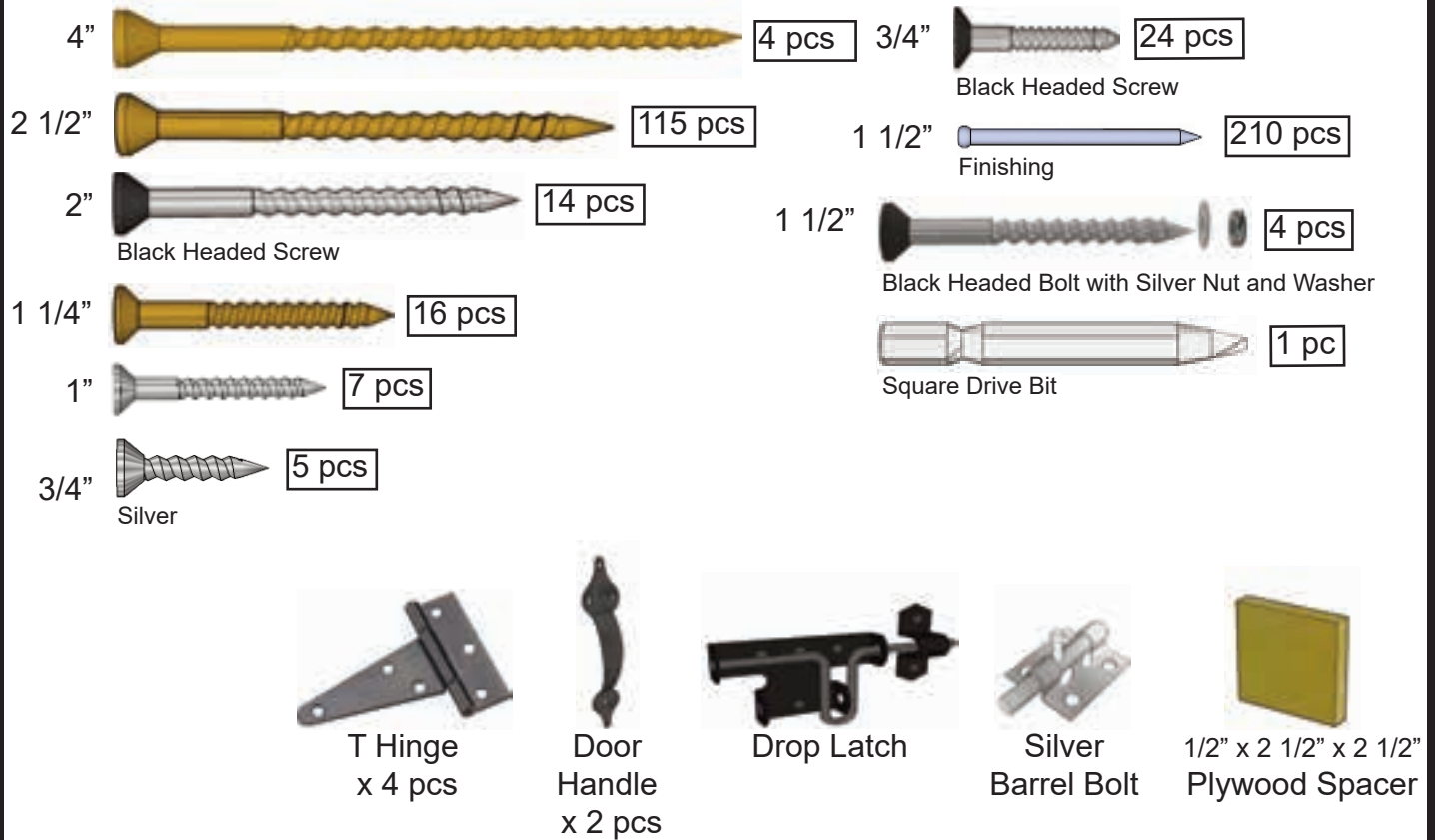

Tools Required (Not Provided)



Safety Equipment Required (Not Provided)



Regular Maintenance & Tips to prolong the life of your shed.

Before/During Assembly:

- 1.) Paint each face and edge of your plywood floor with a latex exterior paint.
- 2.) Caulk wall seams if gaps appear.
- 3.) Caulk around window framing.
- 4.) Caulk perimeter between floor plywood and bottom wall plate.
- 5.) Caulk channels in lap siding at the top of your door above the trim, just a drop in each channel.
- 6.) Caulk edge of door threshold.
- 7.) Optional: Install a Sill Gasket between floor runners and foundation.
- 8.) Optional: Install an 8" strip of roofing paper below Cedar Ridge Caps for Cedar Roof Sheds.

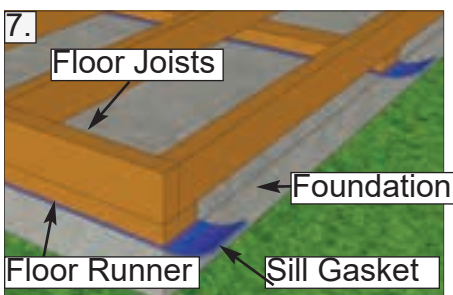
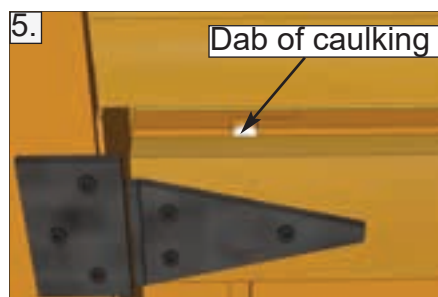
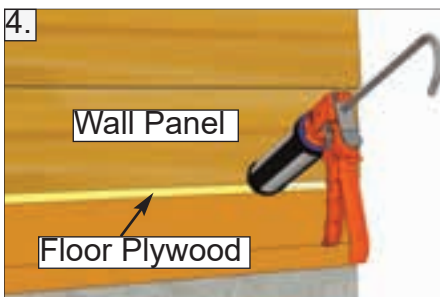
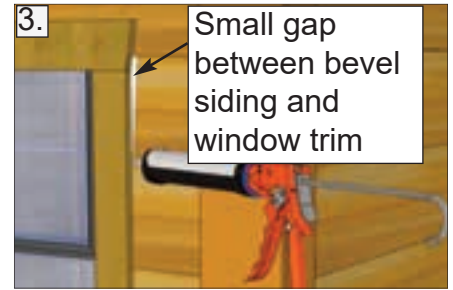

Routine Maintenance:

- Routinely check all fasteners are tight (ex. Door Hinges, Nails)
- Brush off dirt from walls.
- Brush off snow from roof regularly.
- Routinely remove needles and leaves from cedar roof.

Painting/Staining

- Your cedar shed, if left untreated, will weather to a silvery grey colour.
- Painting or staining your structure is highly recommended and will prolong the life of your shed.
- You do not need to wait to paint or stain your shed, the wood in your kit has been dried and can be stained or painted immediately.
- Consult your local paint store for the best paint or stain for cedar.
- Optional: stain the inside of your shed. (Note: this will remove the fresh cedar smell.)

A. Floor Section

Exploded view of all parts necessary to complete the Wall Section. Identify all parts prior to starting.

Floor Section

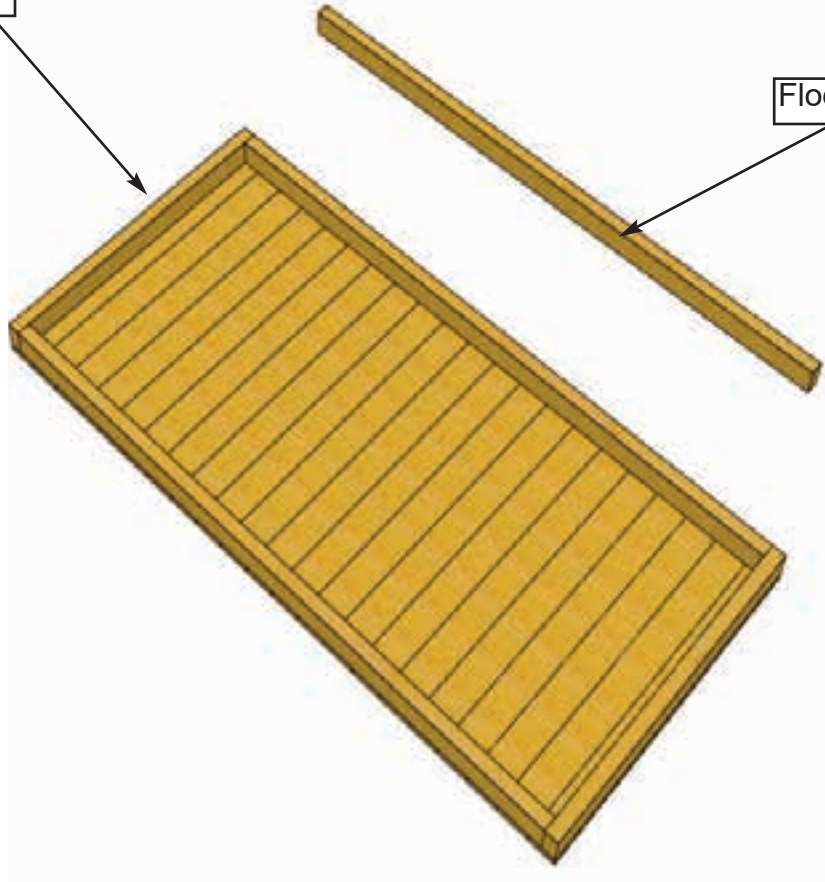

Floor Joist

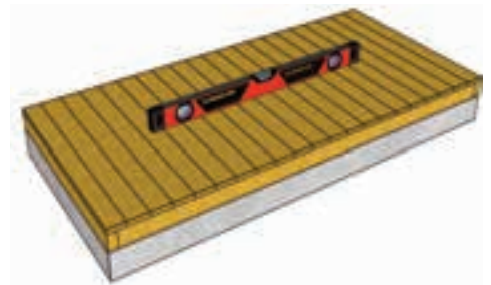
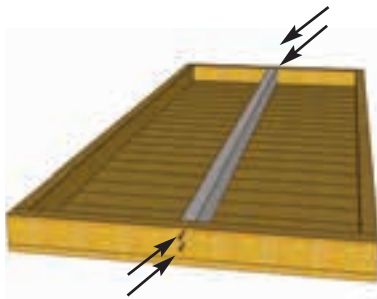

1. Locate **Floor Joist** and position at center of **Floor Section** and flush with framing as illustrated above. Attach with **2 - 2 1/2" Brown Screws** per end. Flip over and lay Floor Section on a level foundation only. Patio Stones or a Concrete Slab both make excellent foundations. (See Page 3 for more information on foundations). Use a level to confirm and shim Floor Joist as required.

Parts

Floor Joist
(1 1/2" x 2 1/2" x 70") x 1
Floor Section
(35" x 73") x 1

Hardware

2 1/2" Brown Screws
x 4 total

B. Wall Section

Exploded view of all parts necessary to complete the Wall Section. Identify all parts prior to starting.

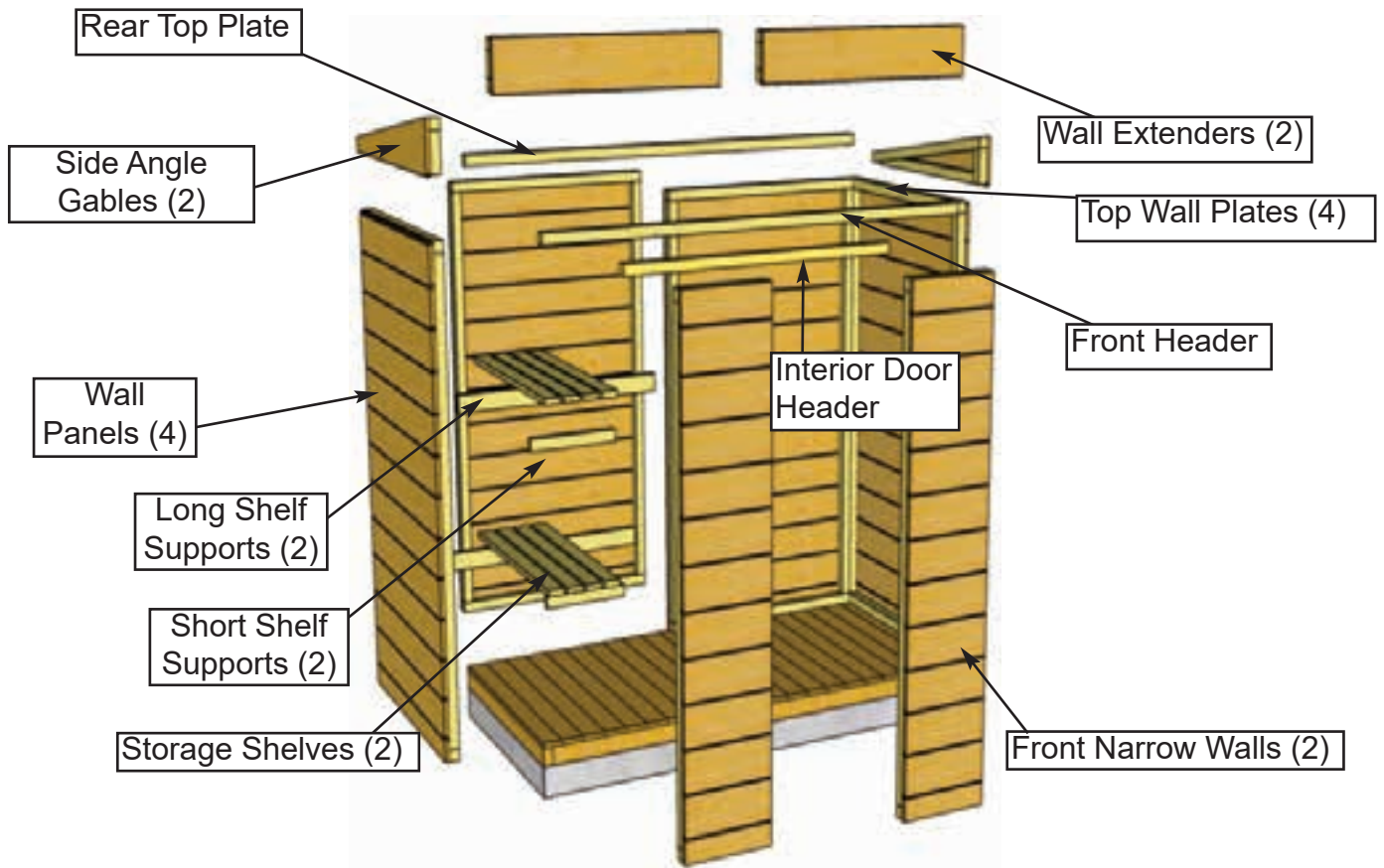

Due to packaging constraints, top wall plates must be attached prior to erecting walls.

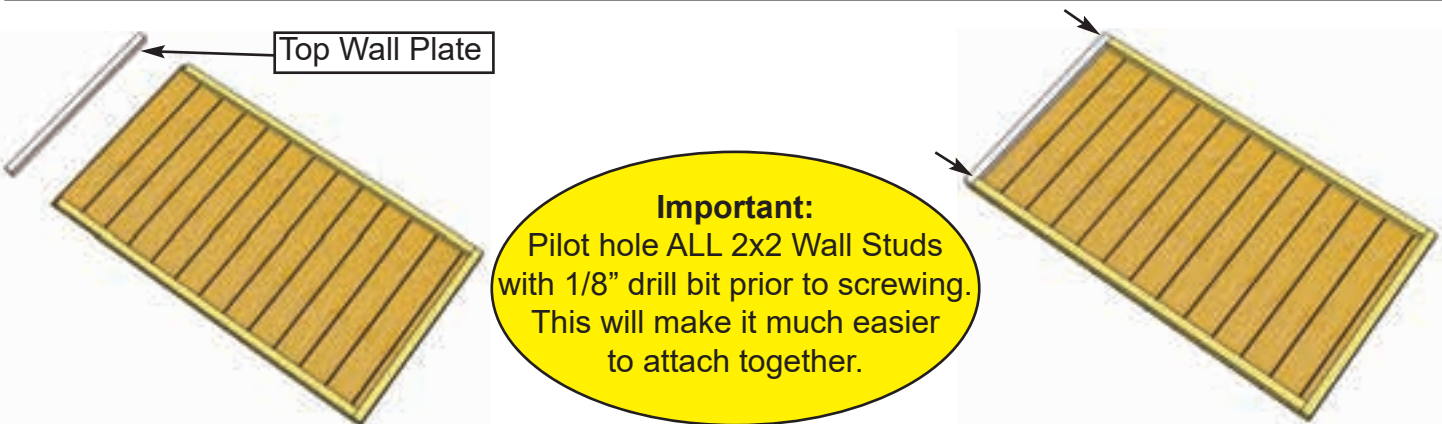

2. For each **Rear and Side Wall Panel**, carefully lay Panel face down. Position and attach a **Top Wall Plate** to top of wall studs of each Wall Panel with **2 - 2 1/2" Brown Screws**. Position so Plates are flush with framing.

Parts	Hardware
Rear/Side Wall Panels (35" x 63 1/4") x 4 Top Wall Plates (1 1/2" x 1 1/2" x 35") x 4	2 1/2" Brown Screws x 8 total

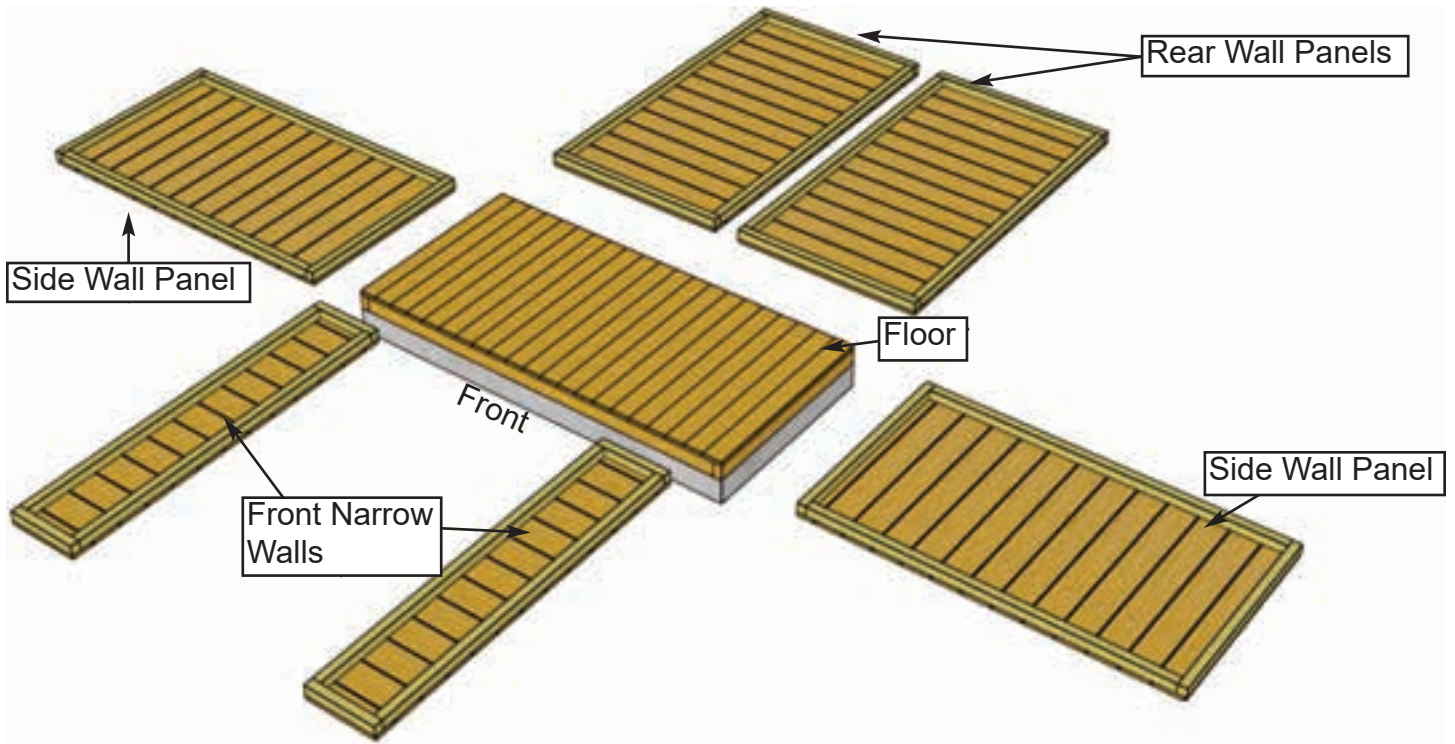

3. With Wall Plates properly attached, orientate completed Walls around the Floor. Be sure to leave room to work. **Front Narrow Walls** will be required in this section.

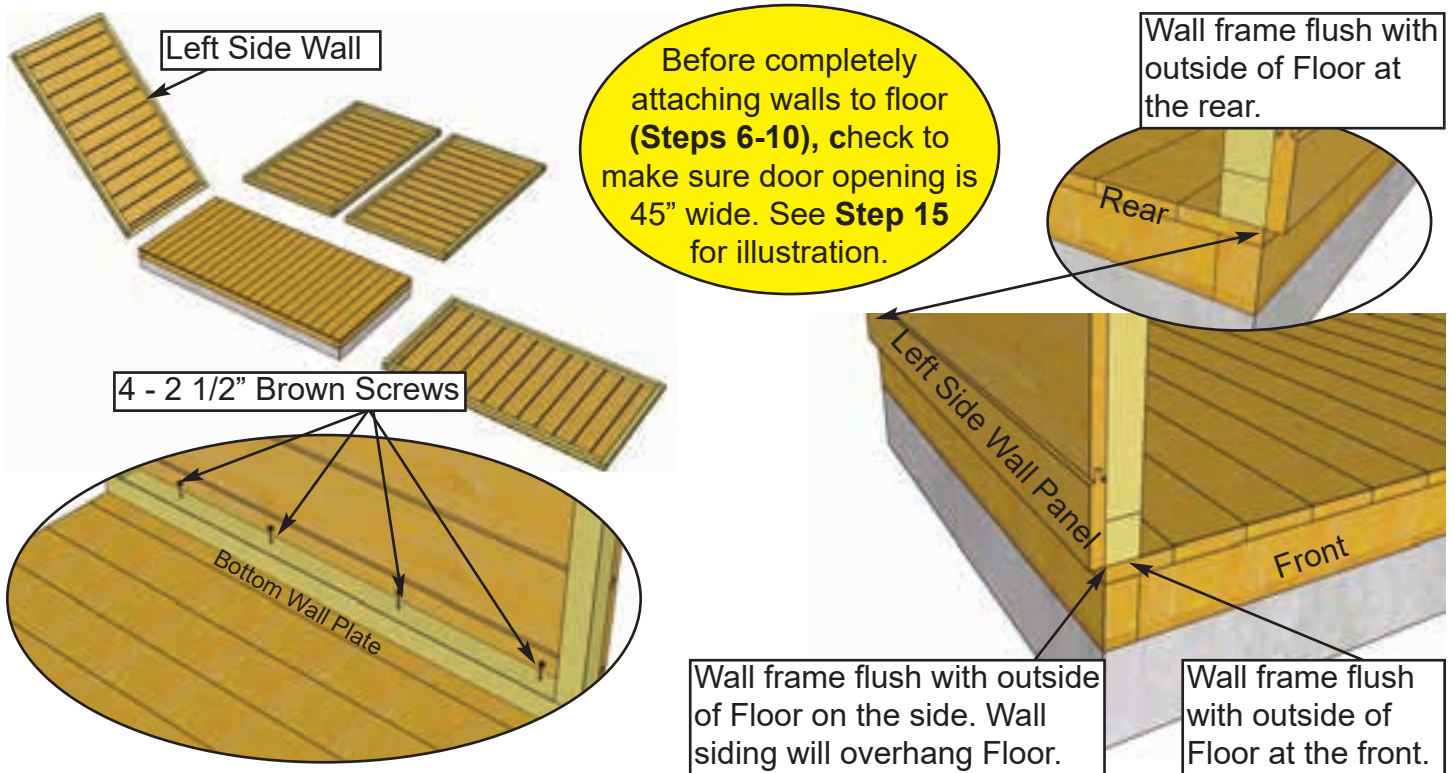

4. Starting with **Left Side Wall**, lift up and position so framing is flush with Floor at both front and rear of shed. Make sure Wall frame is flush with outside of Floor on the side. When Wall is positioned correctly, secure Bottom Wall Plate to Floor with **4 - 2 1/2" Brown Screws**.

Hardware (Steps 4 - 8)
2 1/2" Brown Screws
 x 25 total

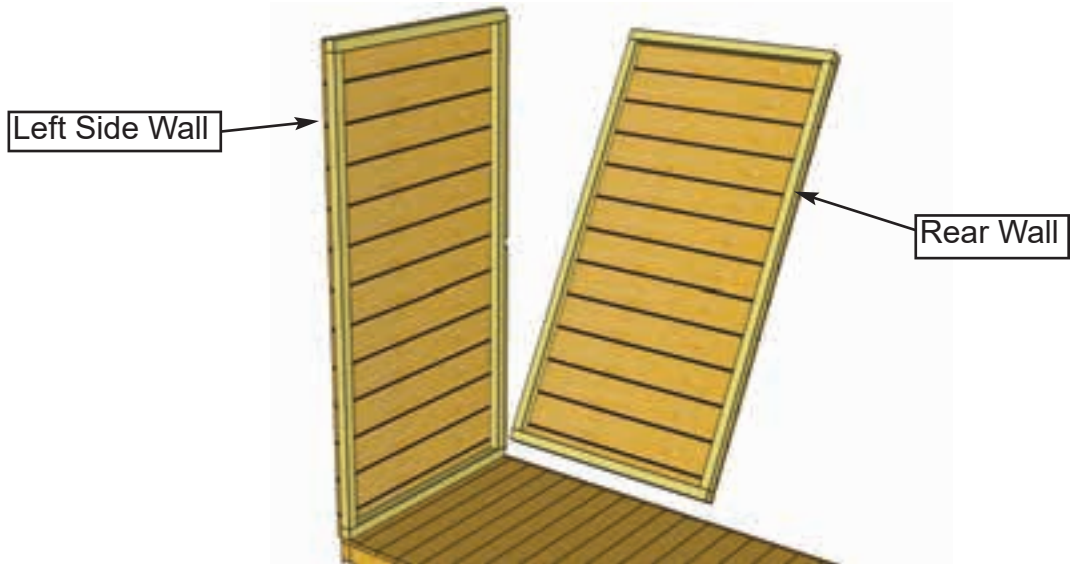

5. With your helper holding the Side Wall Panel, position a **Rear Wall Panel** in rear corner. **Important: Align Wall Framing Flush with Floor Framing.**

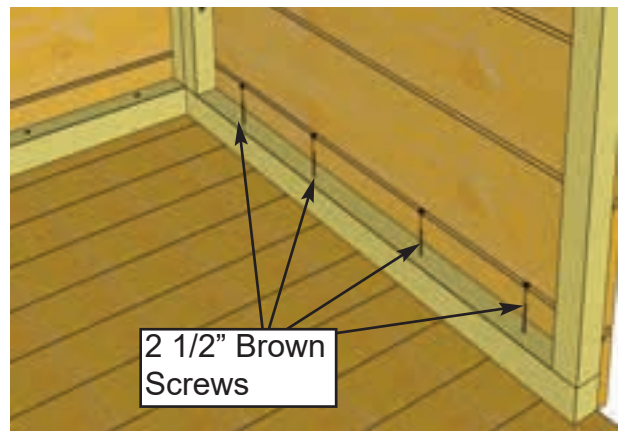
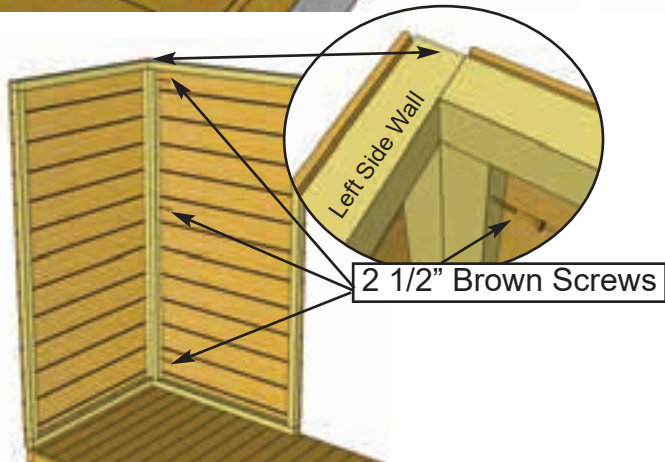
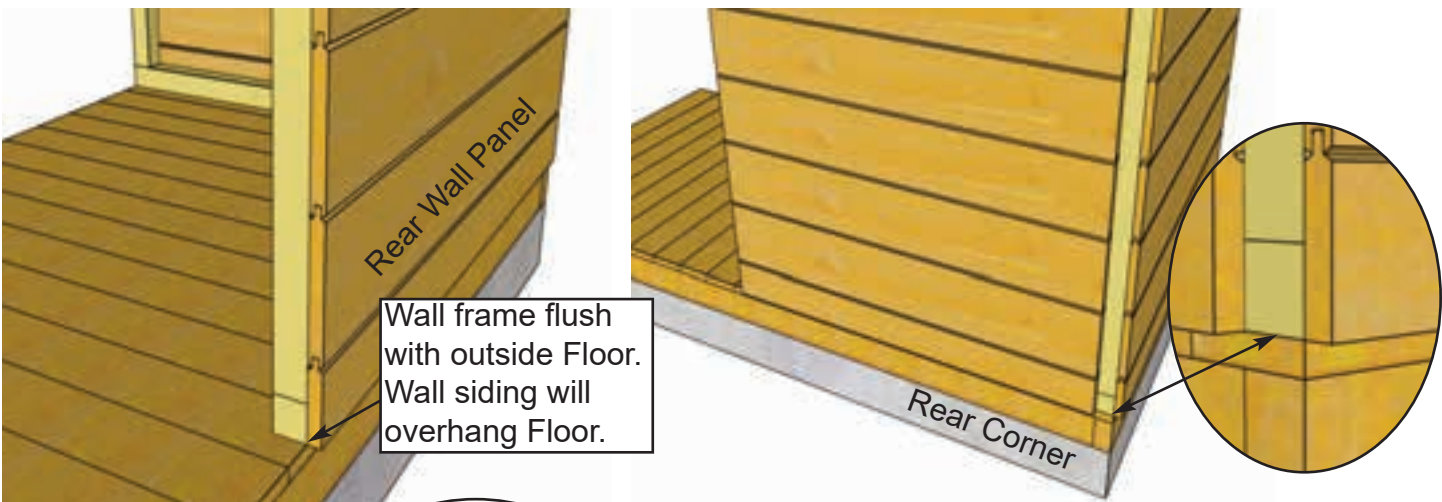

6. When Side and Rear Walls are aligned in corner correctly, Wall framings will be flush. Attach Wall framings together with **3 - 2 1/2" Brown Screws**. Secure Bottom Wall Plate to Floor with **4 - 2 1/2" Brown Screws**.

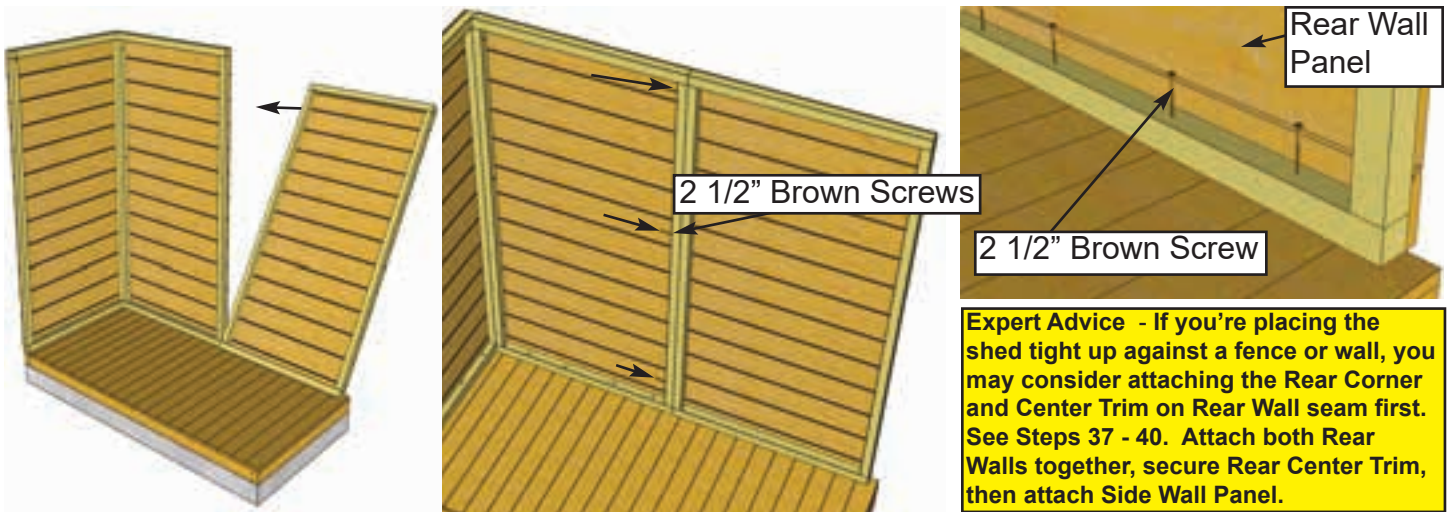

7. Position second **Rear Wall Panel** on Floor as per **Step 6**. Attach Wall frames together at top, middle and bottom with **3 - 2 1/2" Brown Screws**. Secure Bottom Wall Plate to floor with **4 - 2 1/2" Brown Screws**. **Important: Confirm Siding on Rear Wall Panels are aligned.**

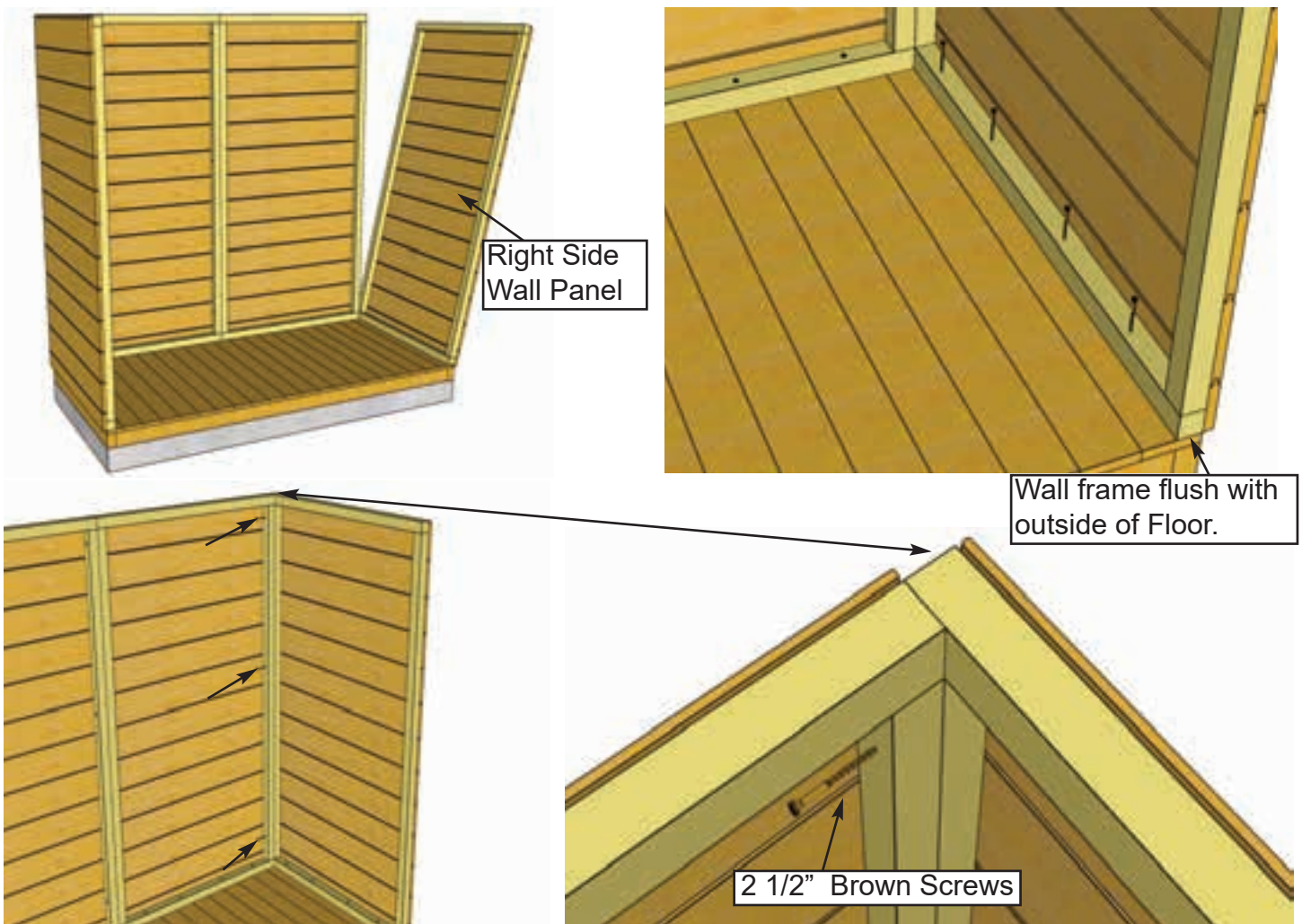

8. In the corner, align and attach Right Side Wall framing to Rear Wall framing with **3 - 2 1/2" Brown Screws** as per **Step 6**. Secure Bottom Wall Plate of Side Wall to Floor with **4 - 2 1/2" Brown Screws**.

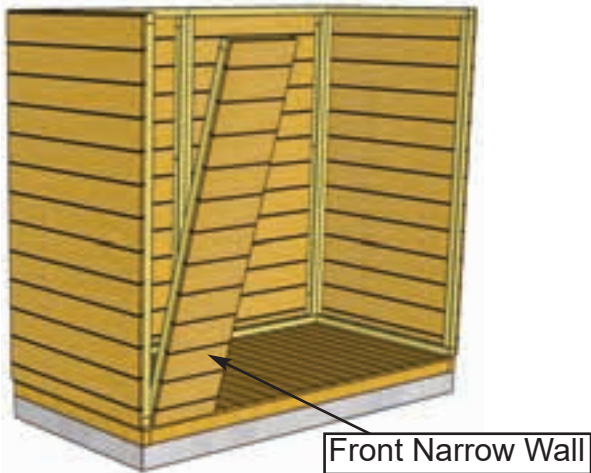

9. Locate **Front Narrow Walls** and position Wall framing flush with Side Wall framing in corner. **Important: Make sure Narrow Wall is positioned right side up.**

Parts (Steps 9 - 11)
Front Narrow Wall Panels
 (12 1/2" x 61 3/4") x 2

Hardware (Steps 9 - 11)
2 1/2" Brown Screws
 x 10 total

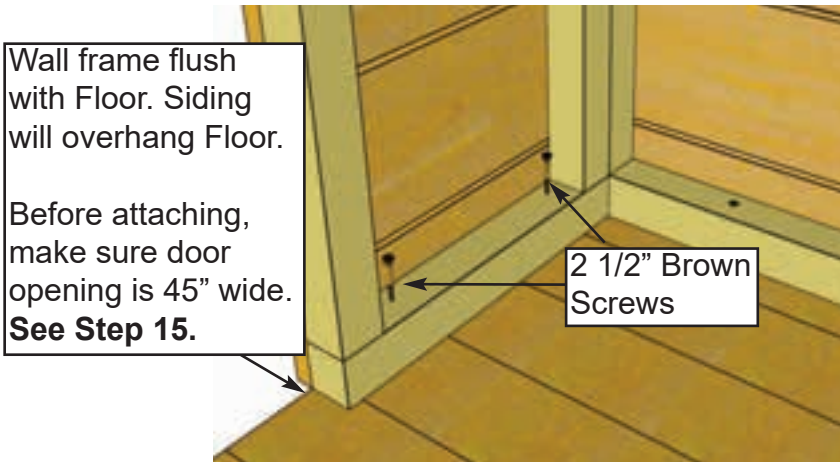

10. Align Wall framing flush with outside of Floor framing. When correctly positioned, secure Bottom Wall Plate to Floor with **2 - 2 1/2" Brown Screws**. Attach vertical Wall framings together at top, middle and bottom with **3 - 2 1/2" Brown Screws**.



11. Align and attach the second **Front Narrow Wall Panel** as per **Step 10**.

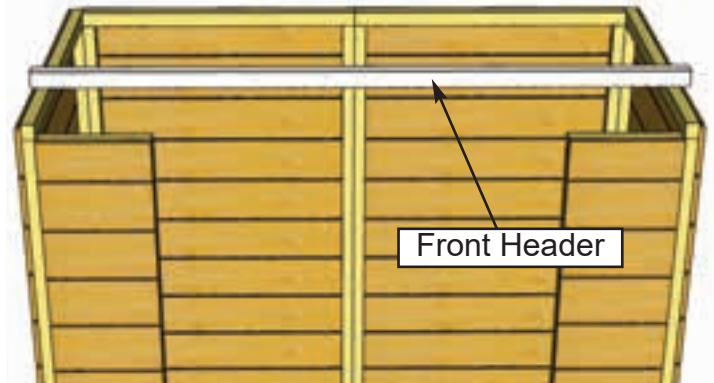

12. Locate **Front Header** and place on top of Front Narrow Wall framings.

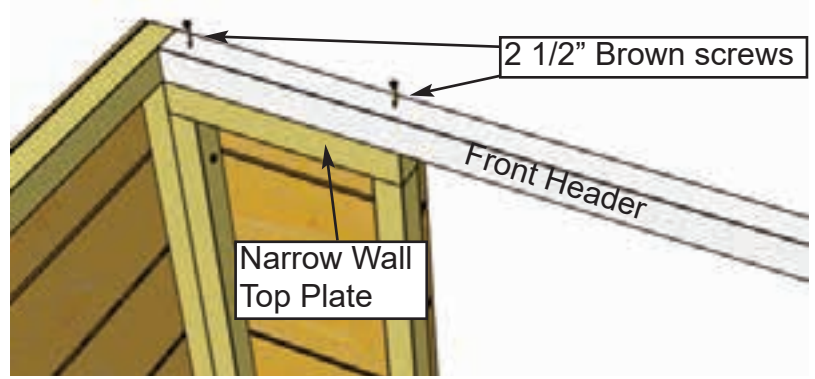
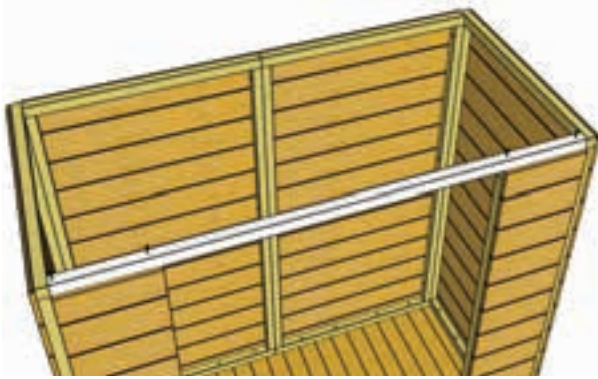

13. With Front Header positioned evenly on Narrow Wall top plates and flush against Side Wall top framing, secure using **4 - 2 1/2" Brown Screws** screwing down from the top of Front Header down into the upper Narrow Wall plates. Have your helper push side walls against end of Front Header to achieve tight fit if possible.

<u>Parts</u> Front Header (1 1/2" x 1 1/2" x 70")	<u>Hardware</u> 2 1/2" Brown Screws x 4 total
--	--

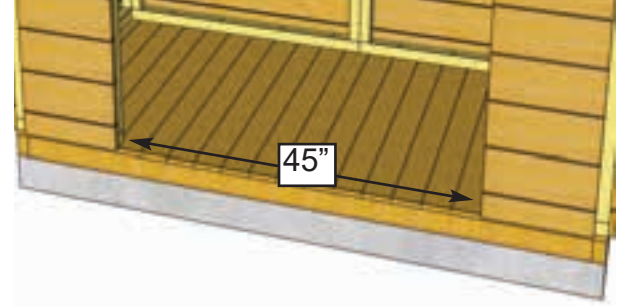
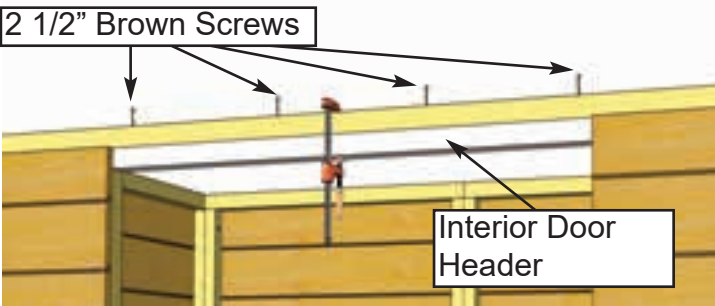

14. Position **Interior Door Header** underneath and flush with Front Header. Attach with **4 - 2 1/2" Brown Screws**. Screw down from the Front Header into Interior Door Header. Use Clamp to hold Interior Door Header.

15. When all Walls are attached together, check door width at top and bottom. Door width should be 45" wide. If required, loosen Narrow and Side Wall plate screws, adjust door width and re-secure. There can be an 1/8" tolerance in the width but top and bottom width should be the same.

<u>Parts</u> Interior Door Header (1 1/2" x 1 1/2" x 44 7/8")	<u>Hardware</u> 2 1/2" Brown Screws x 4 total
--	--

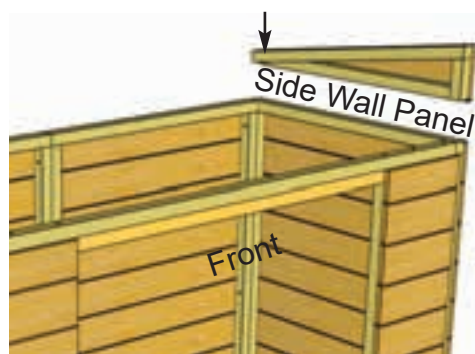

16. Locate both **Left/Right Side Angle Gables**. Place Right Side Angle Gable on Side Wall Panel frame. **Note:** Bottom siding of Gable will overhang and cover siding of Side Wall.

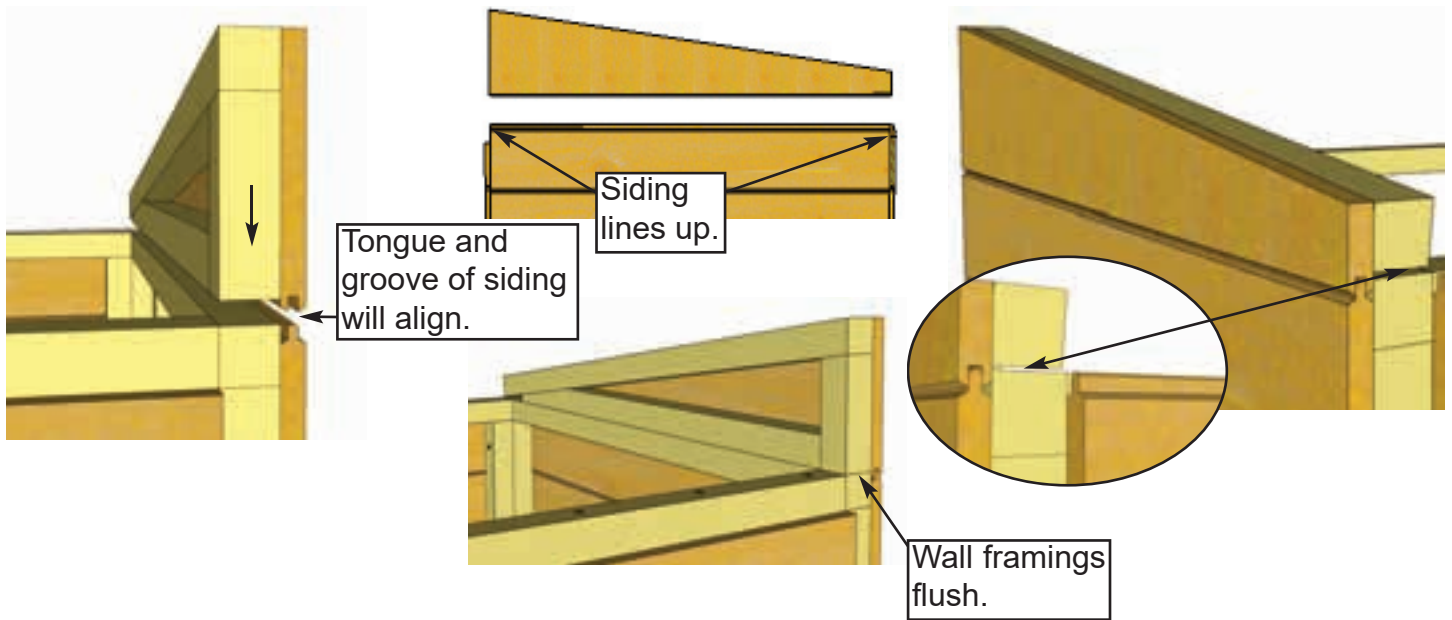

17. Align Wall framing of Right Side Angle Gable and Side Wall so they are flush at the front. The siding for both Walls should also align evenly from front to back.

Parts (Steps 17 - 19)
Left/Right Side Angle Gables
 (6 1/2" x 35")

Hardware (Steps 17 - 19)
2 1/2" Brown Screws
 x 8 total



18. With Right Side Angle Gable and Side Wall aligned correctly, secure together from the inside with 4 - 2 1/2" Brown Screws.

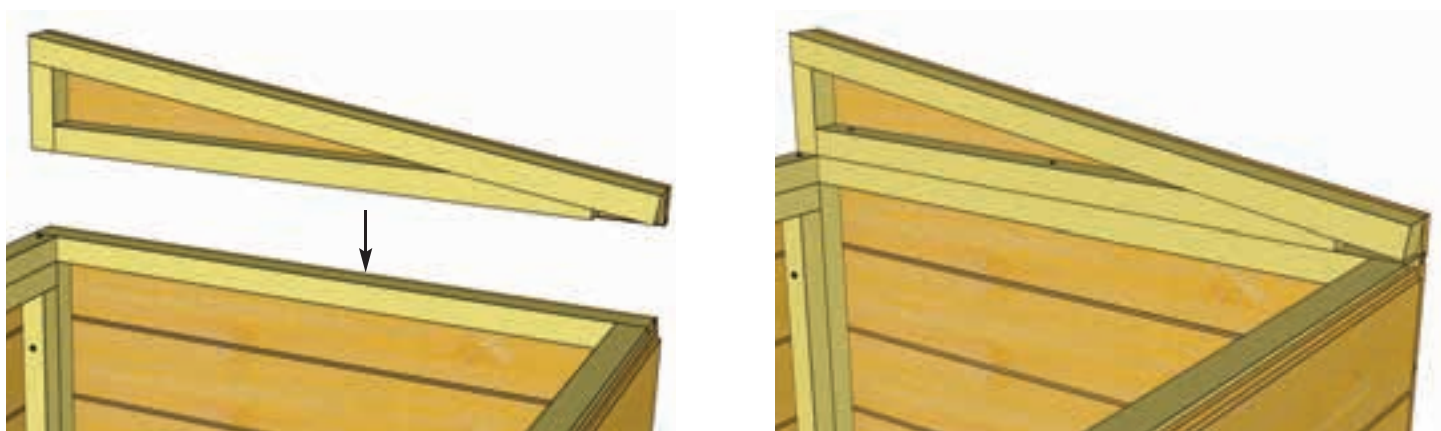

19. Complete opposite **Left Side Angle Gable** positioning and attachment as per **Steps 17 & 18.**

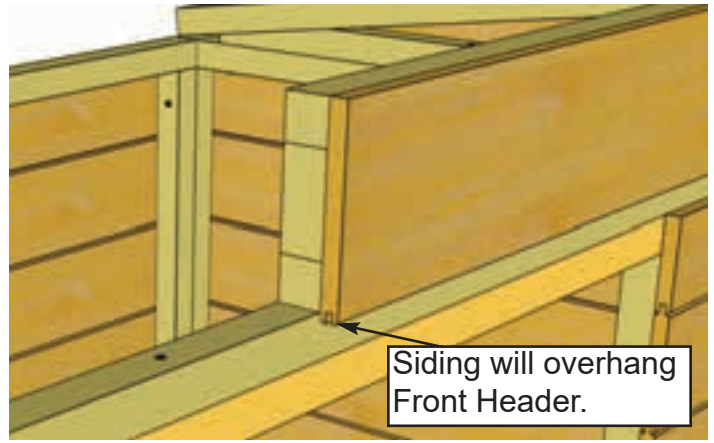
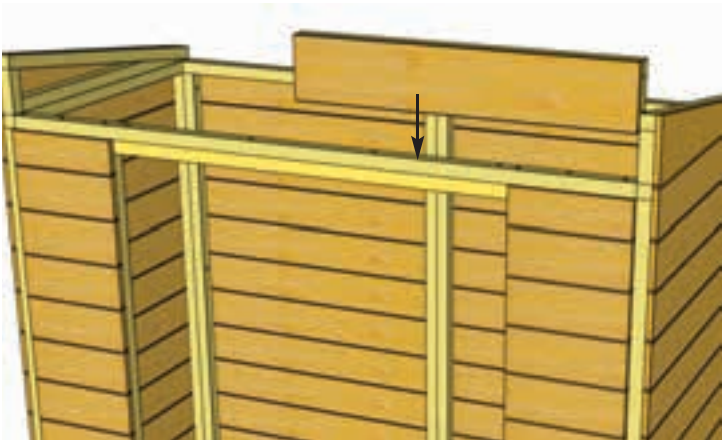

20. Locate one **Wall Extender** and place on Front Header with siding of Wall Extender overhanging Front Header.

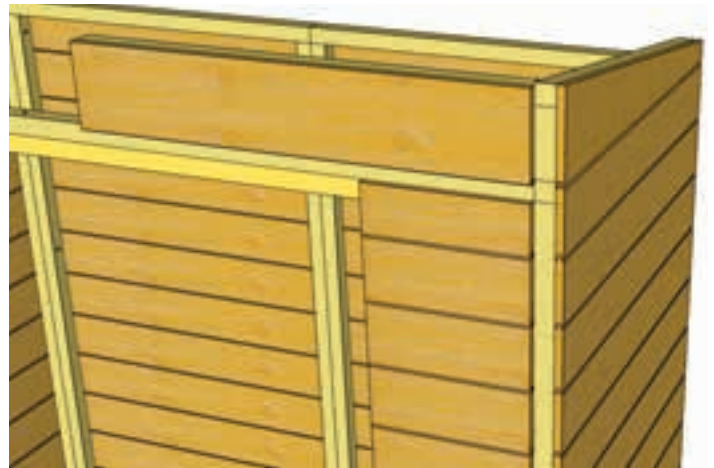
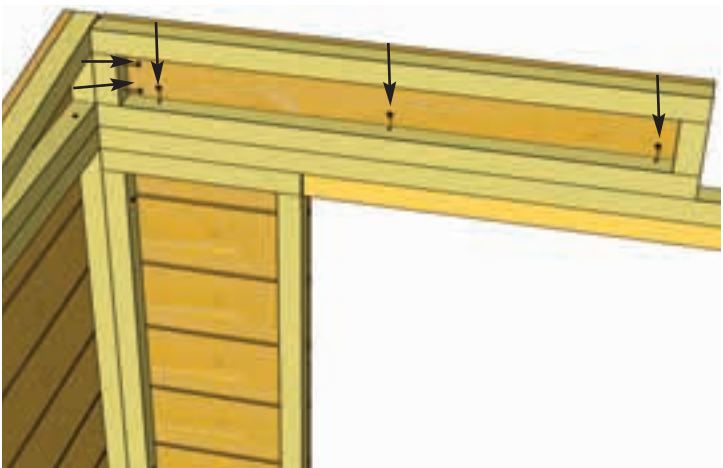

21. With Wall framing aligned, attach Wall Extender to both the Right Side Angle Gable framing and the Front Header with **5 - 2 1/2" Brown Screws**.

<p><u>Parts (Step 21 - 22)</u> Wall Extenders (6 1/4" x 35") x 2</p>	<p><u>Hardware (Step 21 - 22)</u> 2 1/2" Brown Screws x 12 total</p>
---	---

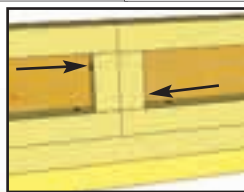
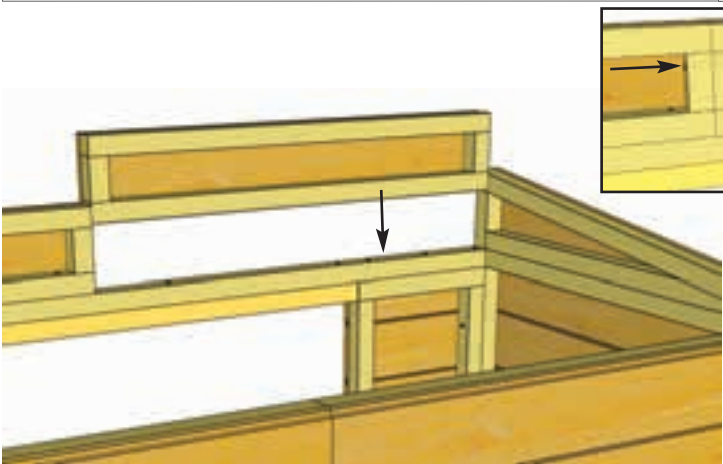

22. Position and secure second **Wall Extender** as per **Steps 20 & 21**. Additionally, attach to first Wall Extender with **2 - 2 1/2" Brown Screws**.

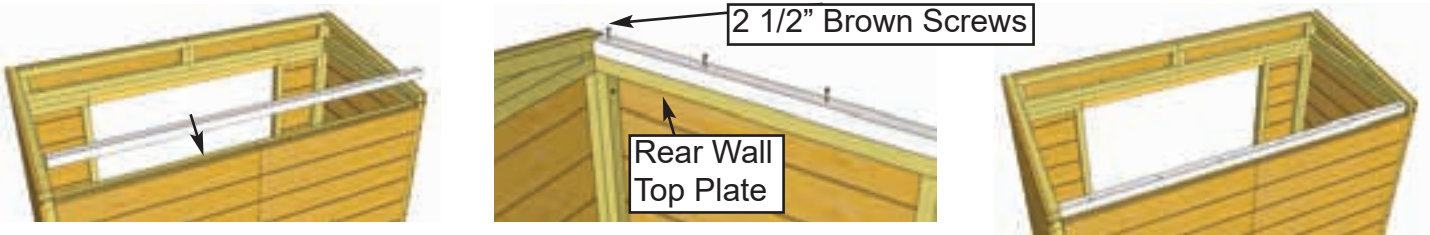

23. Locate **Rear Top Plate** and place on top of Rear Walls. With Rear Top Plate positioned evenly and flush against Rear Wall framing, secure using **6 - 2 1/2" Brown Screws** screwing down from the top of Rear Top Plate down into the Rear Wall top plates.

<u>Parts</u> Rear Top Plate (1 1/2" x 1 1/2" x 70")	<u>Hardware</u> 2 1/2" Brown Screws x 6 total
--	--

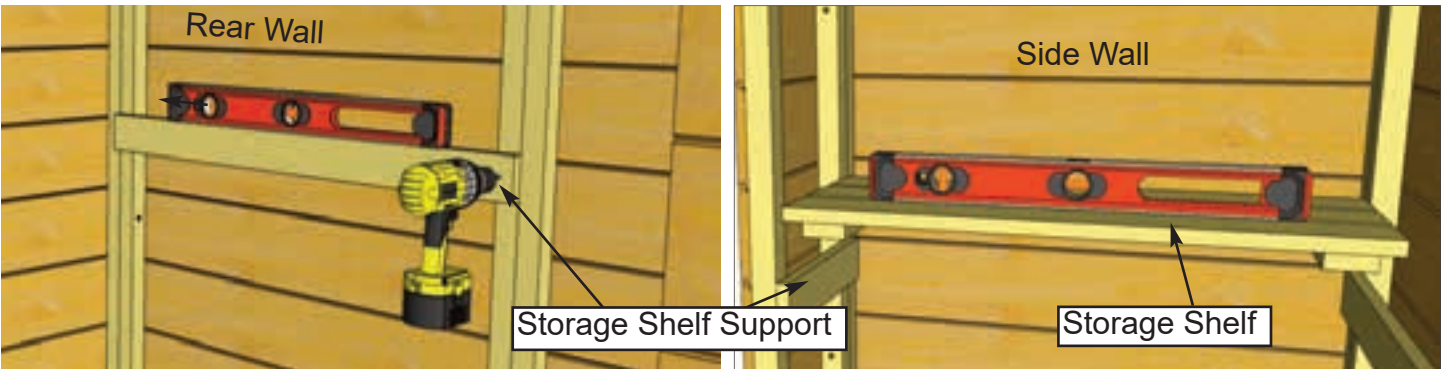

24. Storage Shelf positioning is flexible so decide what height configuration suits your needs. Gather your **Storage Shelf Supports**. The short Support (12 1/2") attaches to the Narrow Wall, the long (35") to the Rear Wall. Position using a Level, and drill Pilot Holes to prevent ends of Supports from splitting. Attach first Support using **2 - 1 1/4" Brown Screws**. Place **Storage Shelf** on attached Support, Level, and mark position of second Support. Pilot Hole and secure second Support.

<u>Parts (Steps 24 - 25)</u> Short Storage Shelf Supports (3/4" x 2 1/2" x 12 1/2") x 2 Long Storage Shelf Supports (3/4" x 2 1/2" x 35") x 2 Storage Shelves (11 1/2" x 31 7/8") x 2	<u>Hardware Parts (Steps 24 - 25)</u> 1 1/4" Brown Screws x 8 total 1 1/2" Finishing Nails x 8 total
--	--



25. Place **Storage Shelf** on top of supports and secure with **4 - 1 1/2" Finishing Nails**. Complete 2nd Shelf (if desired) as per **Steps 24 & 25**.

C. Roof Section

Exploded view of all parts necessary to complete the Roof Section. Identify all parts prior to starting.



Cedar Shingle Roof Panel

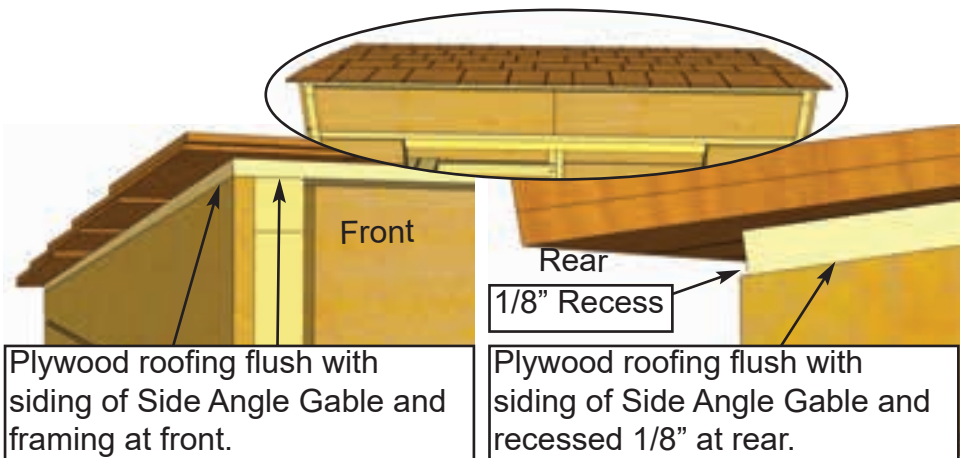
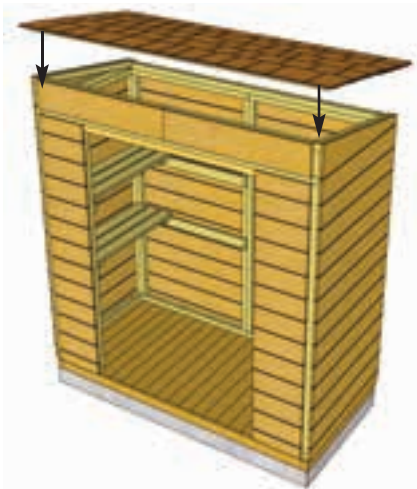

Plywood roofing flush with siding of Side Angle Gable and framing at front.

Plywood roofing flush with siding of Side Angle Gable and recessed 1/8" at rear.

26. Lift up completed **Cedar Shingle Roof Panel** and place on upper wall framing. At the front, align plywood roofing flush with siding of Side Angle Gable at the side and flush with framing of Side Angle Gable at the front. At the rear, align plywood roofing flush with siding of Side Angle Gable at the side, and recessed 1/8" back from framing at rear.

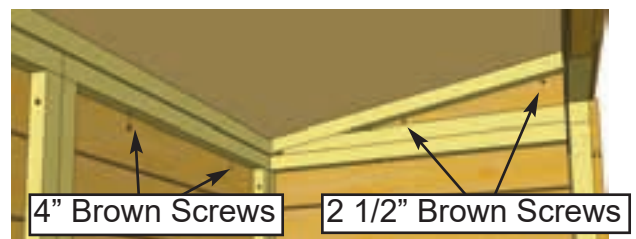
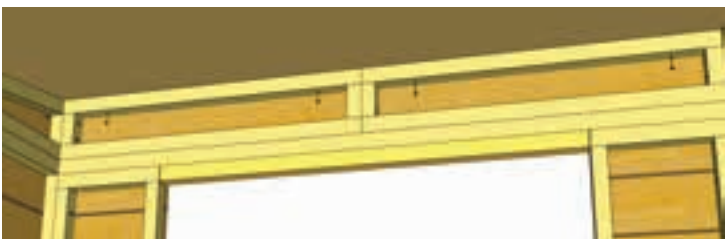

27. From inside the shed, start securing the Roof by attaching the Wall Extenders to Roof Panel on an angle with **4 - 2 1/2" Brown Screws**. Make sure screw tips do not go completely through Roof Panel. At the sides, screw from upper framing into Roof Panel. Use **2 - 2 1/2" Brown Screws** per Side Angle Gable. Screw on an angle and make sure screw tips do not go completely through Roof Panel. At the rear, secure the Roof by screwing through Upper Rear Wall Framing and Rear Wall Top Plate into Roof Panel on an angle with **4 - 4" Brown Screws**.

Parts	Hardware
Cedar Shingle Roof Panel (38 3/4" x 78 1/4")	2 1/2" Brown Screws x 8 total 4" Brown Screws x 4 total

D. Miscellaneous Section

Exploded view of all parts necessary to complete the Skirting, Trim, Fascia and Miscellaneous Pieces. Identify all parts prior to starting.

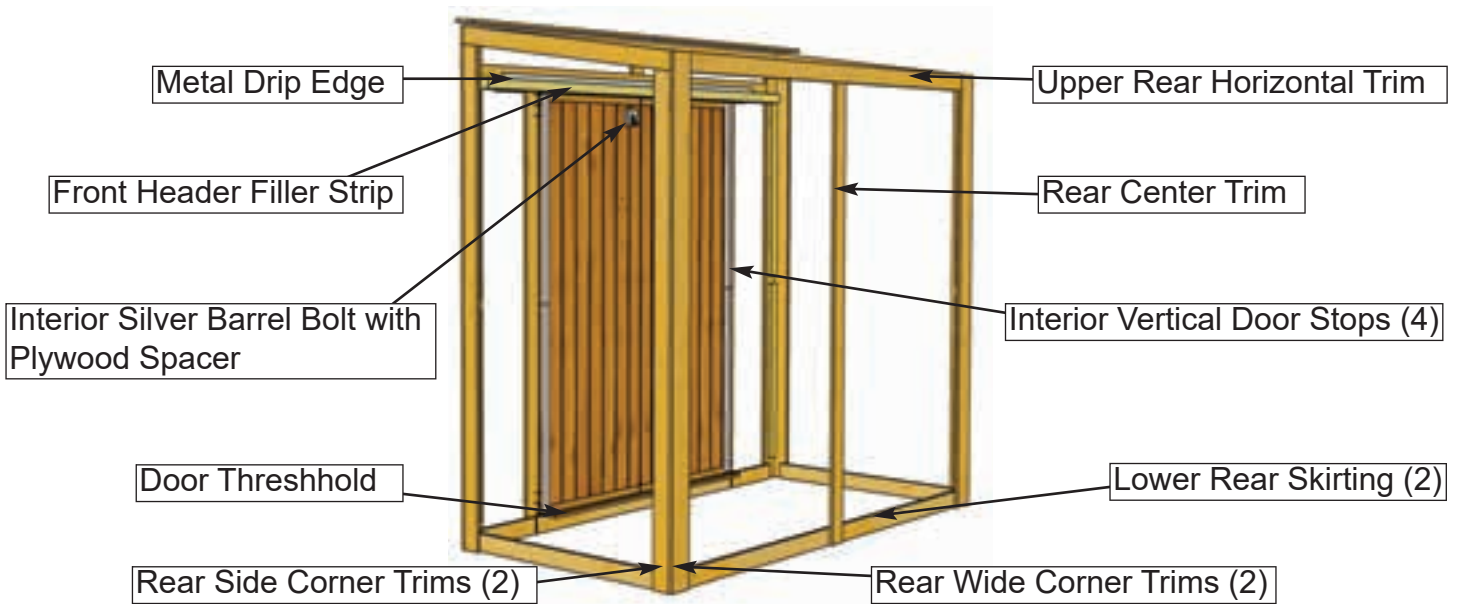
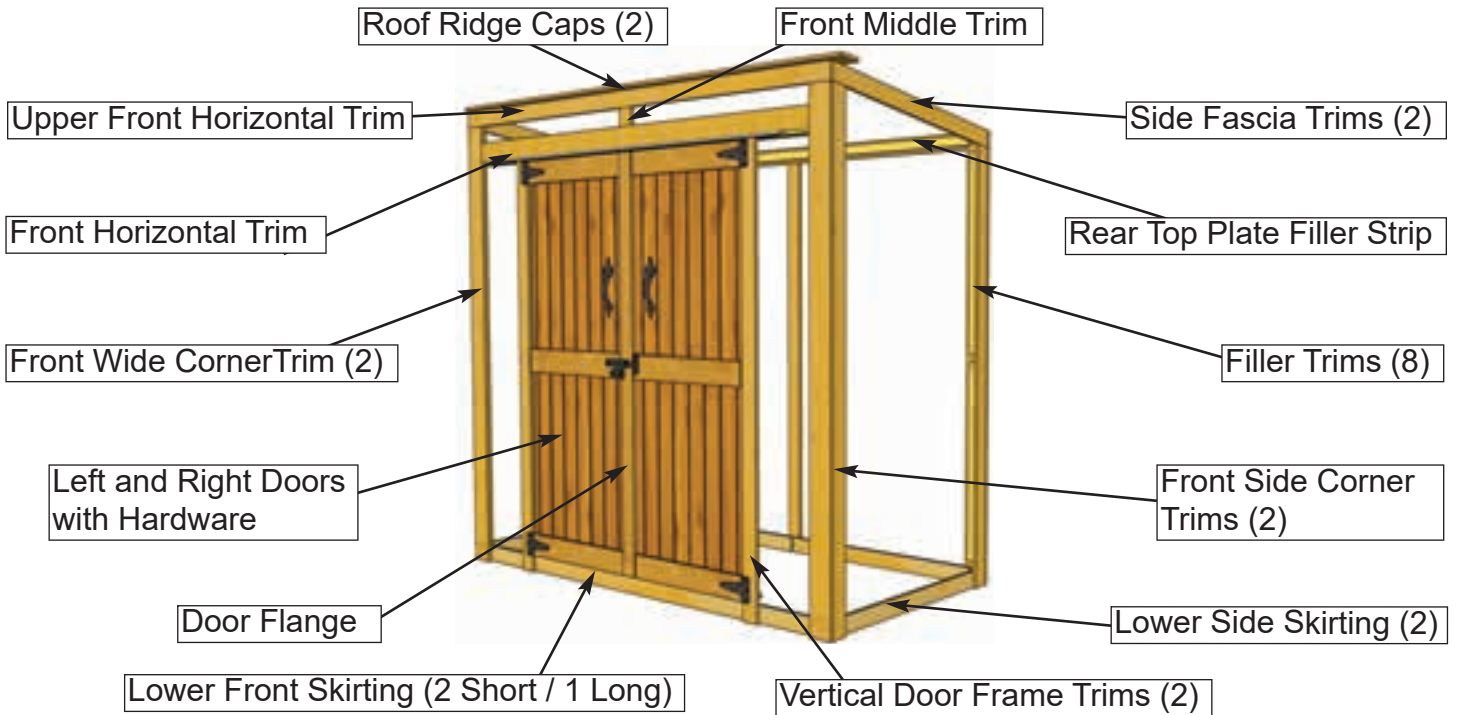

28. Check the wall seams for visible gaps prior to attaching Filler Trim and apply caulk where needed. Caulking gaps will help prevent moisture from entering and will help the longevity of your shed. **Caulking not included in kit.**

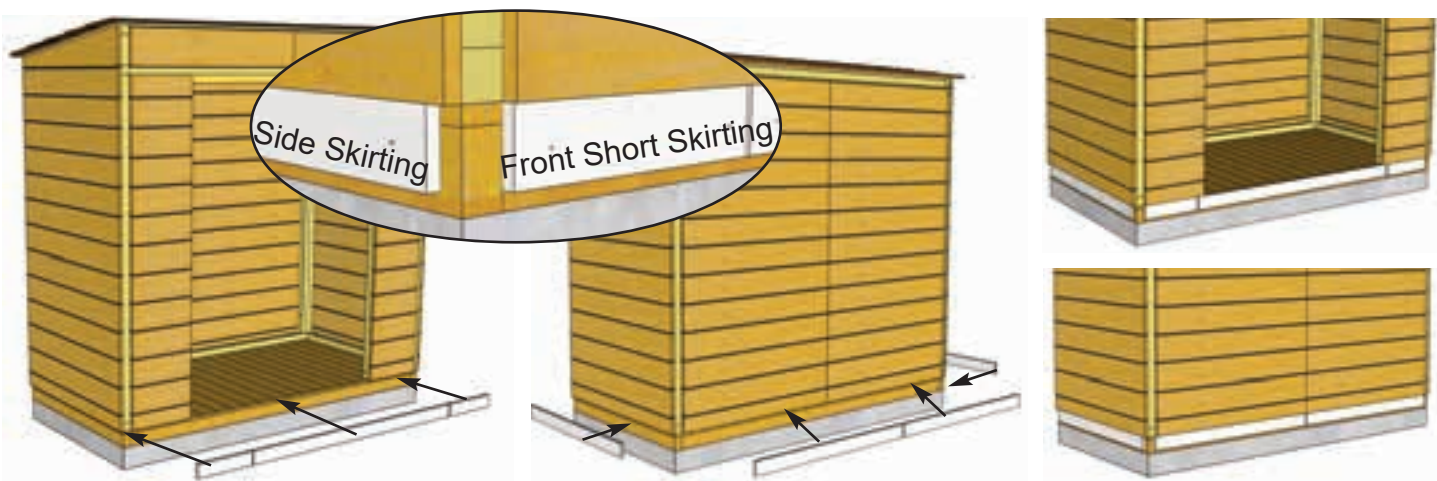

29. Locate **Lower Front Skirting (2 Short and 1 Long)**. Skirting will hide floor framing. Gaps will be covered by Wide Trim pieces later. Attach 2 Lower Short Front Skirting pieces with **2 - 1 1/2" Finishing Nails** per piece. Attach Lower Front Long Skirting with **4 - 1 1/2" Finishing Nails**. Locate **Lower Side and Rear Skirting** and attach with **4 - 1 1/2" Finishing Nails** per piece.

<u>Parts</u>	<u>Hardware</u>
Lower Front Skirting Short (1/2" x 2 1/2" x 11 1/8") x 2 Long (1/2" x 2 1/2" x 47 1/4") Lower Side Skirting (1/2" x 2 1/2" x 33") x 2 Lower Rear Skirting (1/2" x 2 1/2" x 35") x 2	1 1/2" Finishing Nails x 24 total

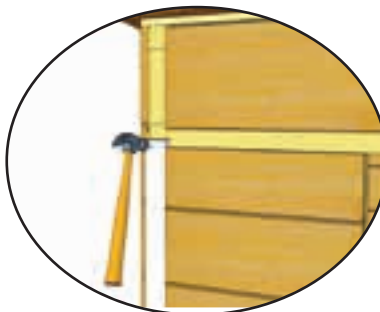

30. Locate 4 **Front Filler Trims**. Filler trim will be covered by Corner Trim in **Step 36**. Attach in each front corner with **3 - 1 1/2" Finishing Nails** per piece.

<u>Parts (Step 30 - 31)</u>	<u>Hardware (Step 30 - 31)</u>
Front/Rear Filler Trims (5/8" x 1 1/2" x 30") x 8	1 1/2" Finishing Nails x 24 total

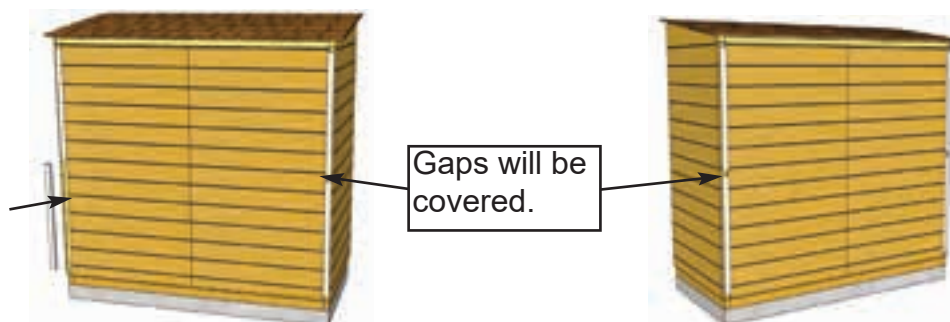

31. Position and attach **Rear Filler Trims** in the rear as per **Step 30**.

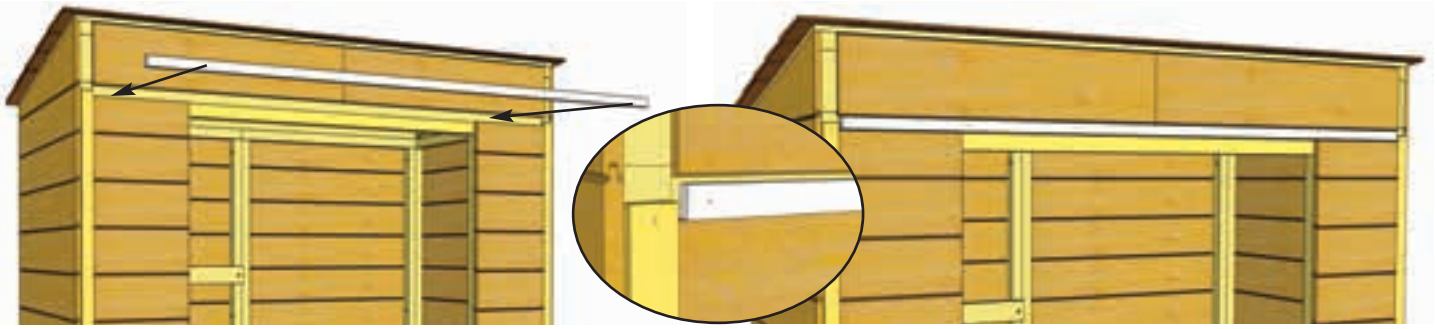

32. Locate **Front Header Filler Strip**. Position Front Header Filler Strip between Front Narrow Walls and Wall Extenders. Evenly space from side to side. Secure with **6 - 1 1/2" Finishing Nails** into Front Header.

<u>Parts</u> Front Header Filler Strip (5/8" x 1" x 69 1/2")	<u>Hardware</u> 1 1/2" Finishing Nails x 6 total
---	---

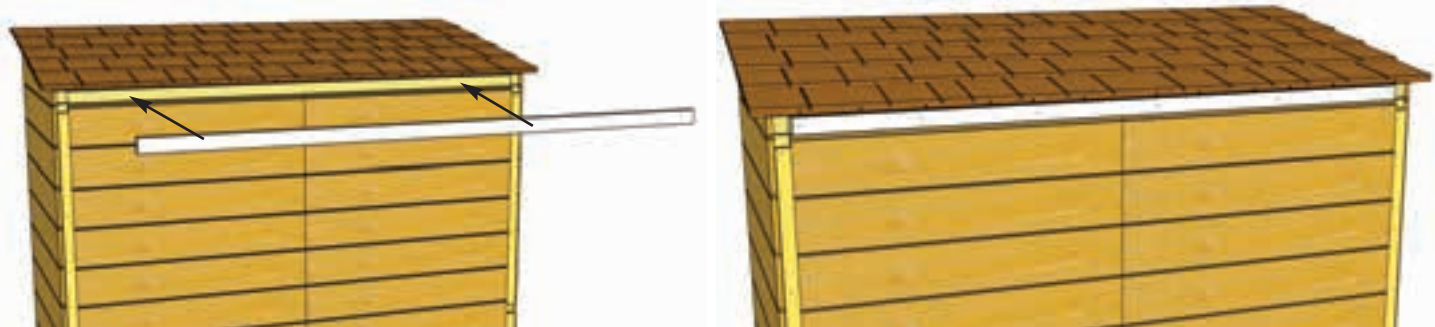

33. Locate **Rear Top Plate Filler Strip**. Position between Rear Walls and Cedar Roof. Evenly space from side to side. Secure with **6 - 1 1/2" Finishing Nails** into Rear Rear Top Plate.

<u>Parts</u> Rear Top Plate Filler Strip (5/8" x 1 1/2" x 69 1/2")	<u>Hardware</u> 1 1/2" Finishing Nails x 6 total
---	---



34. Locate **Upper Front Horizontal Trim** and position underneath Roof Panel. Evenly space from side to side. Secure with **6 - 1 1/2" Finishing Nails** into Wall Extenders.

<u>Parts</u> Upper Front Horizontal Trim (1/2" x 2 1/2" x 74 1/4")	<u>Hardware</u> 1 1/2" Finishing Nails x 6 total
---	---

Expert Advice:
Do a dry run with Front and Rear Corner Trims before attaching. Confirm the rough face is configured correctly and small trim gaps are satisfactory before attaching.

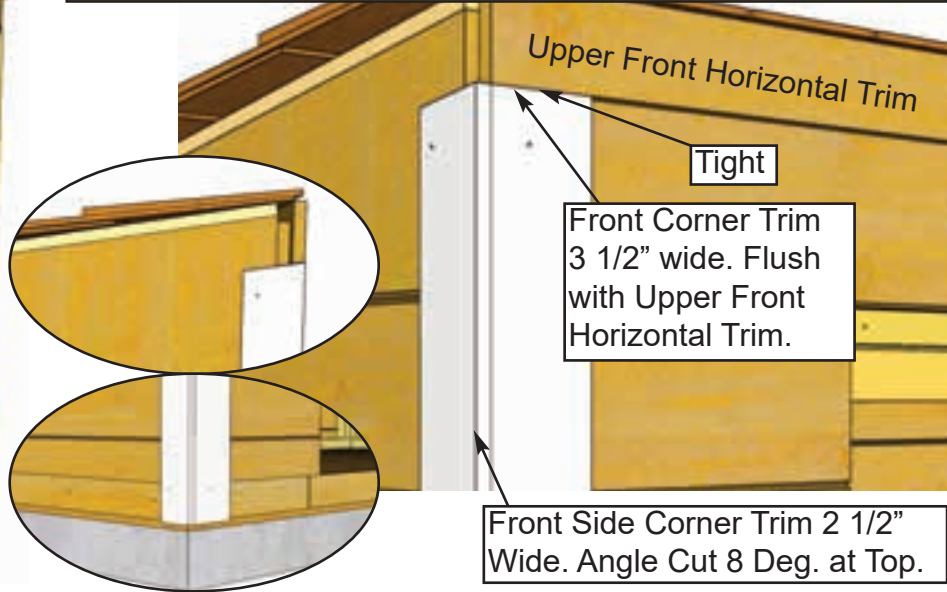

35. Locate a **Front Wide Corner Trim** and **Front Side Corner Trim**. Angled Side Trim pieces are unique to each corner and are attached **rough side out**. Starting in one corner, position both Trims up tight underneath Upper Front Horizontal Trim. Align Front Wide Corner Trim flush against Upper Front Horizontal Trim. Front Side Corner Trim will cap Front Wide Corner Trim. When correctly aligned, attach each piece with **6 - 1 1/2" Finishing Nails**.

<p><u>Parts</u></p> <p>Front Wide Corner Trim (1/2" x 3 1/2" x 70 3/8")</p> <p>Front Side Corner Trim (Angle Cut At Top) (1/2" x 2 1/2" x 70 3/8")</p>	<p><u>Hardware</u></p> <p>1 1/2" Finishing Nails x 12 total</p>
--	--

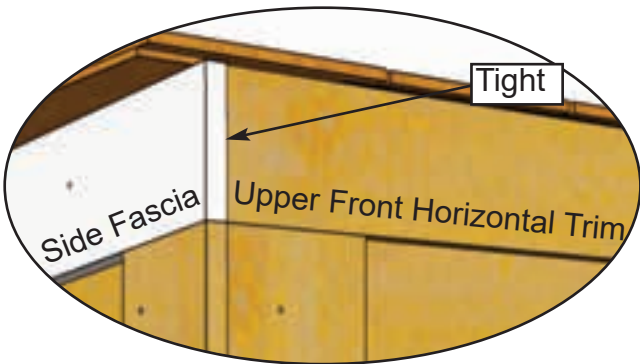

36. Continuing around the shed, place a **Side Fascia Trim** tight against Upper Front Horizontal Trim and underneath Cedar Roof. Align Side Fascia with Side Corner Trim. Attach Side Fascia Trim to Side Angle Gable with **4 - 1 1/2" Finishing Nails**.

<p><u>Parts</u></p> <p>Side Fascia Trim (Angle Cut Both Ends) (1/2" x 2 1/2" x 37 5/8")</p>	<p><u>Hardware</u></p> <p>1 1/2" Finishing Nails x 4 total</p>
--	---

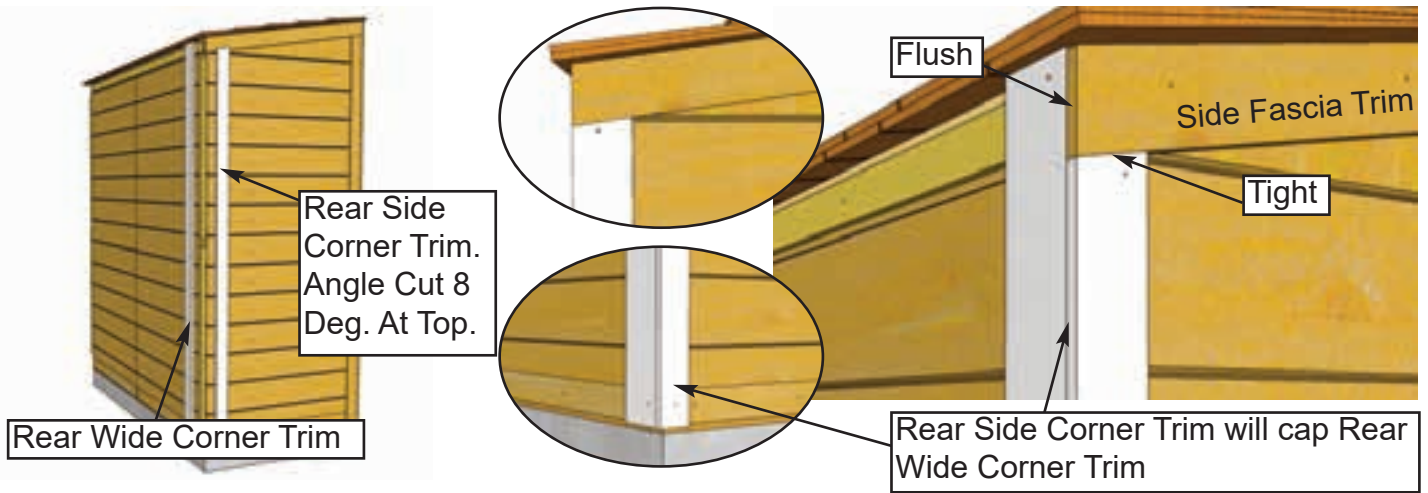

37. Locate a **Rear Side Corner Trim** and **Rear Wide Corner Trim**. Once again, angled Side Trim pieces are unique to each corner and are attached **rough side out**. Position Rear Side Trim tight underneath Side Fascia Trim. Align Rear Wide Corner Trim underneath Cedar Roof Shingles and flush with Side Fascia Trim. Rear Side Corner Trim will cap Rear Wide Corner Trim. Attach each piece with **6 - 1 1/2" Finishing Nails**.

<u>Parts</u> Rear Wide Corner Trim (1/2" x 3 1/2" x 67 3/4") Rear Side Corner Trim (Angle Cut At Top) (1/2" x 2 1/2" x 65 1/2")	<u>Hardware</u> 1 1/2" Finishing Nails x 12 total
---	--



38. Locate **Upper Rear Horizontal Trim** and align tight against Rear Wide Corner Trim and underneath Cedar Roof. Attach to Rear Top Plate Filler Strip with **6 - 1 1/2" Finishing Nails**.

<u>Parts</u> Upper Rear Horizontal Trim (1/2" x 2 1/2" x 67 1/4")	<u>Hardware</u> 1 1/2" Finishing Nails x 6 total
--	---

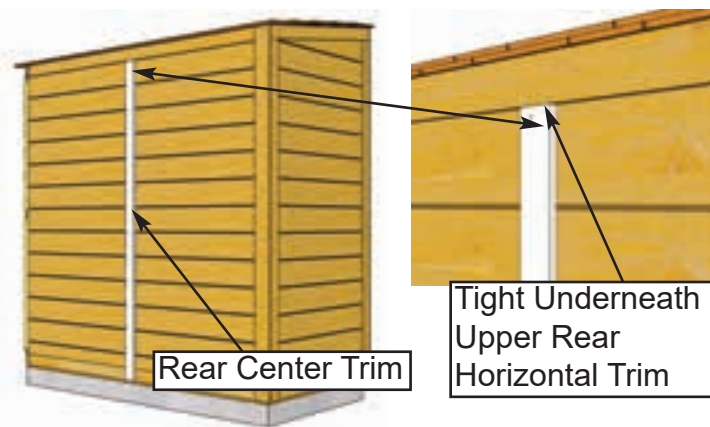

39. Locate **Rear Center Trim**. Align tight against Upper Rear Horizontal Trim and attach with **6 - 1 1/2" Finishing Nails**.

<u>Parts</u> Rear Center Trim (1/2" x 2 1/2" x 65 1/8")	<u>Hardware</u> 1 1/2" Finishing Nails x 6 total
--	---



40. Complete other Rear Corner, Side Fascia and Front Corner Trims as per **Steps 35 - 37**

Parts

Rear Wide Corner Trim

(1/2" x 3 1/2" x 67 3/4")

Rear Side Corner Trim (Angle Cut At Top)

(1/2" x 2 1/2" x 65 1/2")

Side Fascia Trim (Angle Cut Both Ends)

(1/2" x 2 1/2" x 37 5/8")

Front Wide Corner Trim

(1/2" x 3 1/2" x 70 3/8")

Front Side Corner Trim (Angle Cut At Top)

(1/2" x 2 1/2" x 70 3/8")

Hardware

1 1/2" Finishing Nails

x 28 total

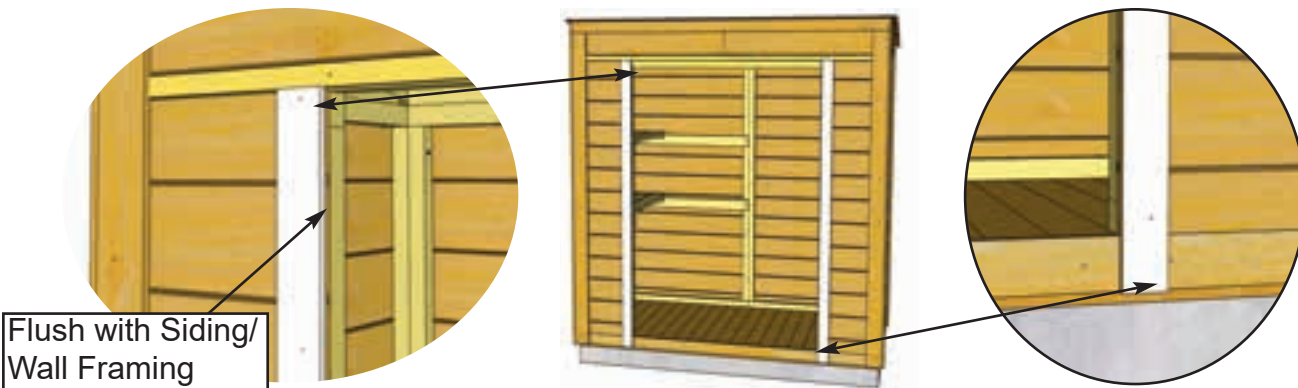

41. Locate 2 **Vertical Door Frame Trims**. Position on Front Narrow Wall flush with Wall siding/ framing and underneath Front Header Filler Strip. Attach with **6 - 1 1/2" Finishing Nails**.

Parts

Vertical Door Frame Trims

(1/2" x 2 1/2" x 64 1/4") x 2

Hardware

1 1/2" Finishing Nails

x 12 total

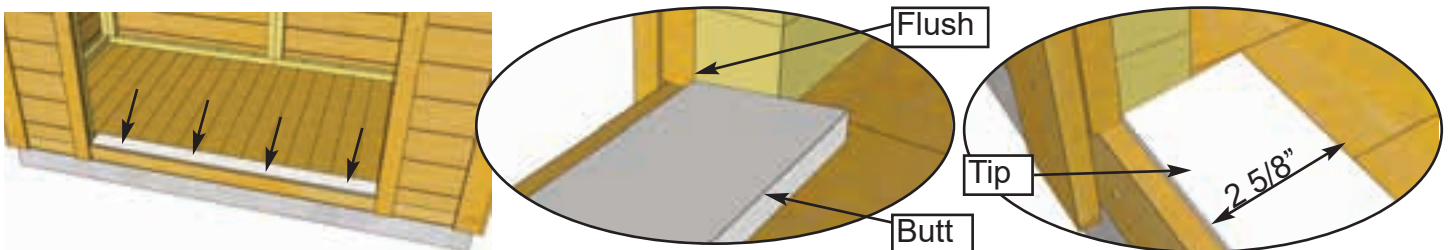

42. Locate **Door Threshold** and position on Floor at the opening. Align tip of the bevel flush with the outside of Bottom Wall Plate. Attach with **4 - 1 1/4" Brown Screws**.

Parts

Door Threshold (Bevel)

(1/2" x 2 5/8" x 44 7/8")

Hardware

1 1/4" Brown Screws

x 4 total

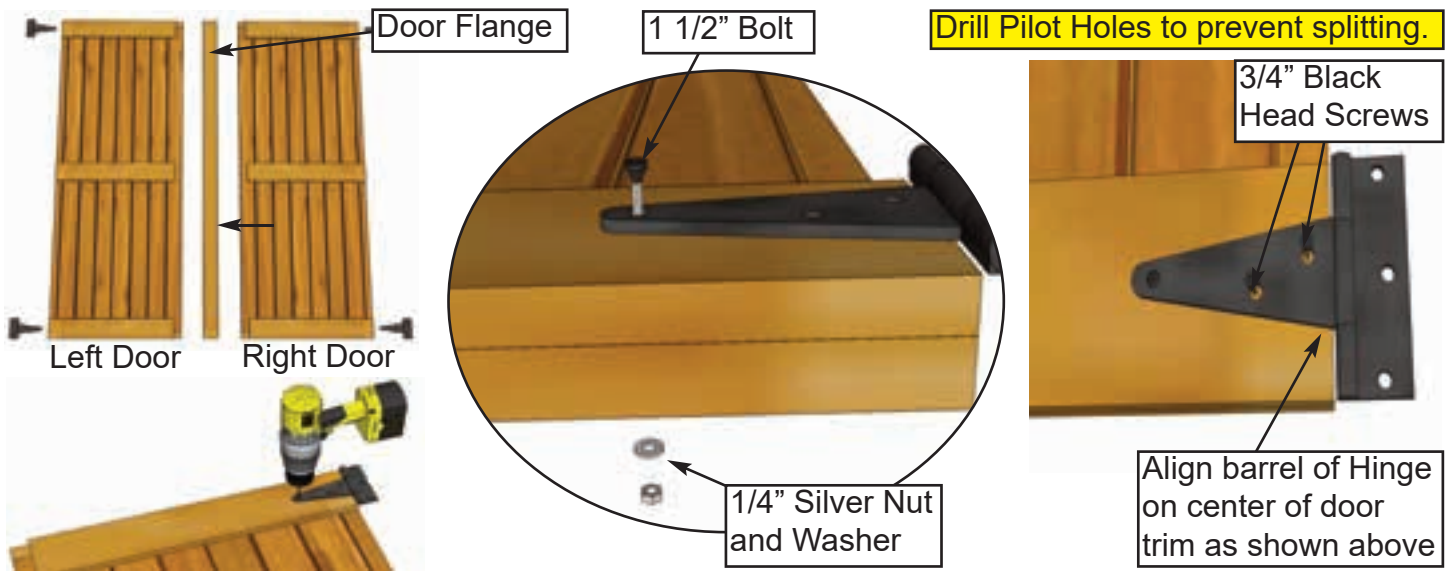

43. Locate **Left and Right Doors** and **Door Flange**. Orientate Doors so the outside of each Door is facing up. Locate **Black T Hinges**. Prior to attaching, position Hinges equally on Door trim as shown above and with a 1/8" drill bit, drill a hole through the tip of the Hinge and all the way through the Door. Complete for all 4 hinges. Attach each Hinge to Door as above with **1 - 1 1/2" Black Headed Bolt**, and a **1/4" Silver Nut and Washer**, using a 3/8" wrench. Finish Hinge by securing with **2 - 3/4" Black Headed Screws**. Drill small pilot holes first to prevent wood from splitting. Complete both Doors (4 Hinges).

Parts (Step 43 - 47)

Left and Right Doors
(22 1/4" x 61 3/8")
Door Flange
(1/2" x 2 1/2" x 61 3/8")

Hardware (Step 43 - 47)

Black T Hinge x 4 total
1 1/2" Black Headed Bolt x 4 total
1/4" Silver Nut and Washer x 4 total
3/4" Black Headed Screws x 8 total
1" Silver Screws x 6 total
2" Black Headed Screws x 12 total

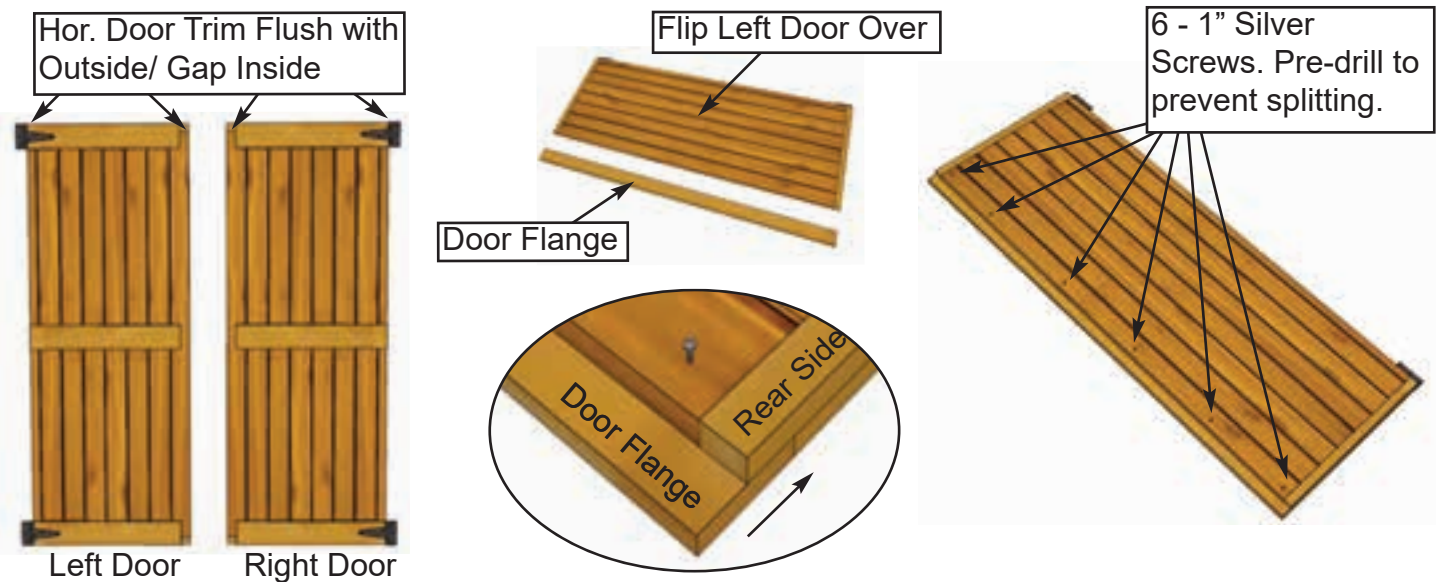

44. Flip Left Door over to attach **Door Flange**. Position Door Flange tight against horizontal trim and even with trim on top and bottom. If out slightly, make sure top horizontal trim and Flange are even. Pre-drill with 1/8" bit to prevent wood from splitting. Attach with **6 - 1" Silver Screws**.

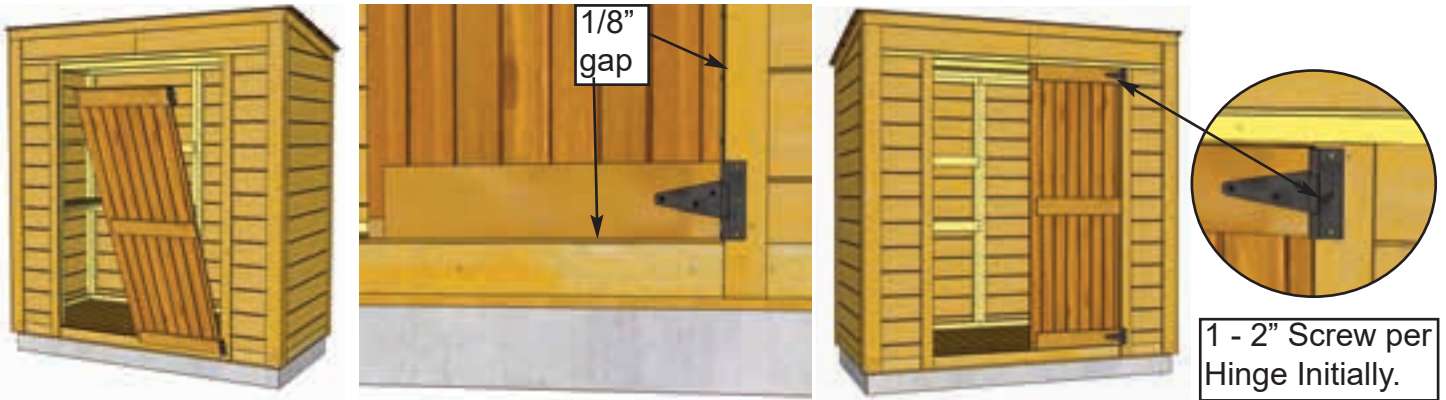

45. Starting with Right Door first, lift and position Door in opening. Leave a 1/8" gap on right side and 1/8" gap on the bottom. Use a **Cedar Shingle Shim** to shim the Door at bottom to help position door evenly. When Door is aligned correctly, screw Hinge into Vertical Door Frame Trim with **1 - 2" Black Headed Screws**. Use only 1 screw initially per Hinge until both Door alignments are confirmed. Drill pilot holes to prevent wood from splitting.



46. Position Left Side Door (with Flange) as per **Step 45**. Once again, use only **1 - 2" Black Headed Screw** per Hinge initially to secure door to Vertical Door Frame Trim.



47. With both Doors partially attached, check to see Doors open and close correctly. Make any necessary adjustments and when satisfied, completely secure Hinges to Vertical Door Frame Trim with **two more 2" Black Headed Screws** per Hinge. Drill pilot holes to prevent wood from splitting.



48. Attach **Door Handles** to Doors with **4 - 3/4" Black Headed Screws** per Handle. Choose desired Handle height.

<p>Hardware Black Handle x 2 total 3/4" Black Headed Screws x 8 total</p>



Important: Drill shallow Pilot Holes to prevent splitting.

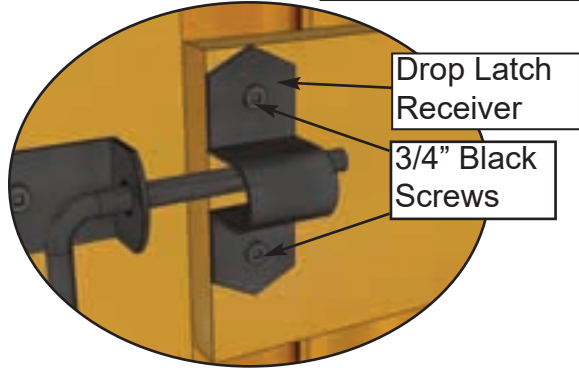

49. Attach **Black Drop Latch** as illustrated above with **6 - 3/4" Black Headed Screws**.
Note: Black Drop Latch receiver is positioned higher than male. Do a dry run first to position Black Drop Latch correctly. **Important** - Drill pilot holes with 1/8" drill bit prior to securing with screws to prevent wood splitting.

Hardware
Black Drop Latch
3/4" Black Headed Screw x 6 total

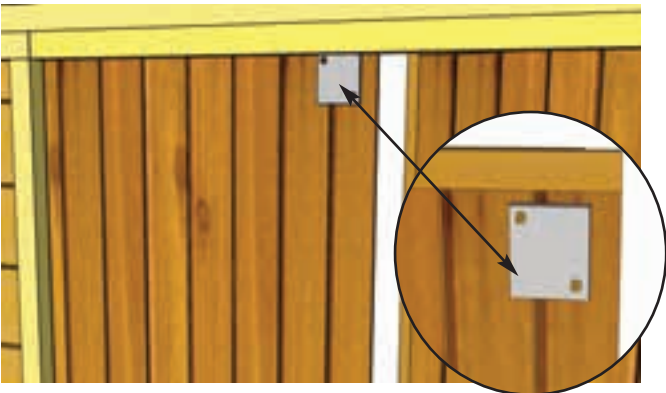

50. Install the **Plywood Spacer** to interior door frame approximately 1 1/2" from top of door frame and 1" from edge, as pictured. Use **2 - 1 1/4" Brown Screws** to secure. Plywood Spacer should fit flush underneath Interior Door Header when Door is closed.

Hardware
Plywood Spacer (1/2" x 2 1/2" x 2 1/2")
1 1/4" Brown Screws x 2 total



51. Position the **Interior Silver Barrel Bolt** on the Plywood Spacer and attach with **4 - 3/4" Silver Screws**. Tap Silver Barrel Bolt with hammer on underside of Interior Door Header to mark location.

Hardware
Interior Silver Barrel Bolt
3/4" Silver Screws x 4 total

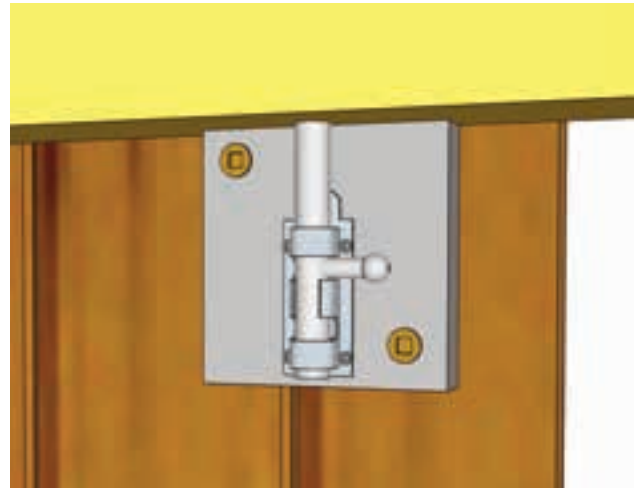

52. Open Door and drill out marked Silver Barrel Bolt impression with a 3/8" Drill Bit. Close Door, slide Interior Silver Barrel Bolt in drilled hole to confirm fit.

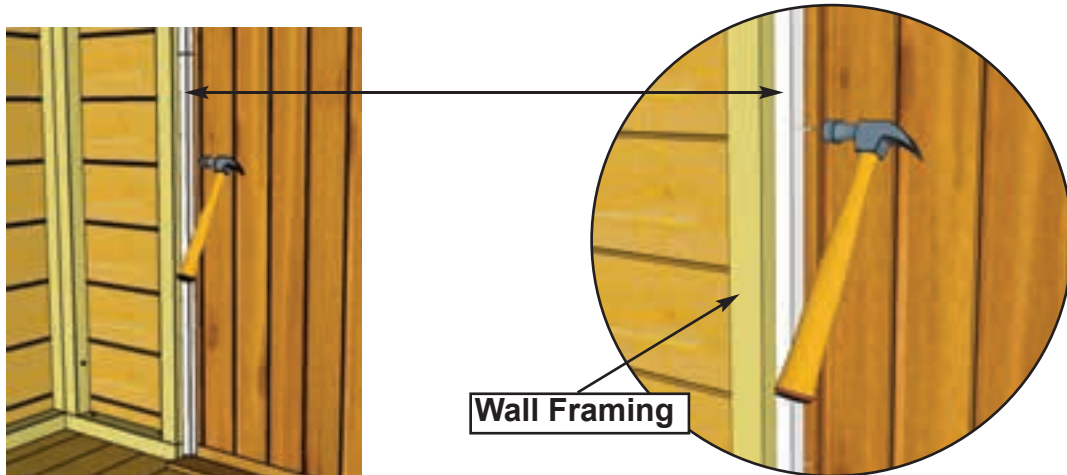

53. Attach **Interior Vertical Door Stops** to inside Wall framing with **4 - 1 1/2" Finishing Nails** per piece. To align correctly, close Door to make sure Stops are close to the Door but don't interfere with their closing. Attach bottom piece first with hammer.

Parts (Step 53 - 54)
Interior Vertical Door Stops
 (3/4" x 3/4" x 29 7/8") x 4

Hardware (Step 53 -54)
1 1/2" Finishing Nails
 x 16 total

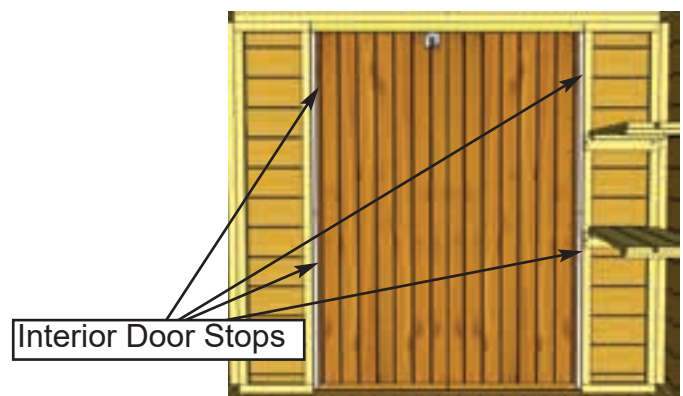
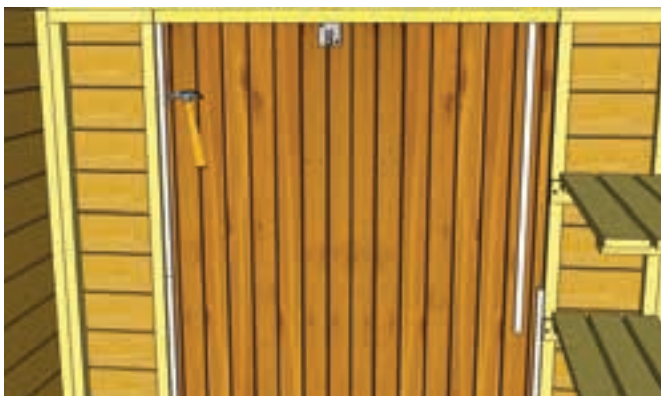

54. Attach top Interior Door Stop as per **Step 53** and then complete the opposite side.

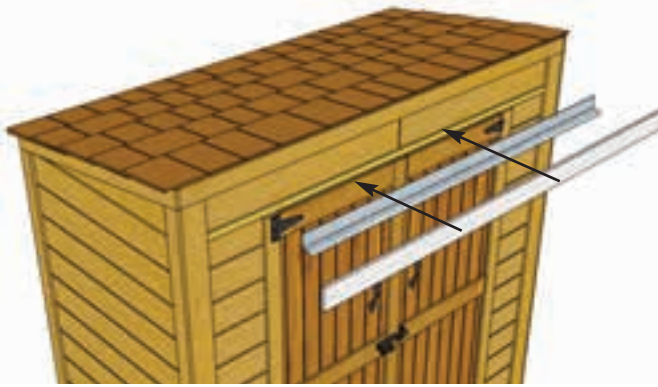

55. Locate **Front Horizontal Trim** and **Metal Drip Edge**. Position Metal Drip Edge behind Door Trim. Evenly space from side to side. While holding down both Metal Drip Edge and Front Horizontal Trim, secure with **6 - 1 1/2" Finishing Nails** into Front Header Filler Strip.

<u>Parts</u> Front Horizontal Trim (1/2" x 3" x 67 1/4") Metal Drip Edge (60")	<u>Hardware</u> 1 1/2" Finishing Nails x 6 total
---	---



56. Locate **Front Middle Trim** and position tight against Horizontal Above Door Trim and Upper Front Horizontal Trim. Attach with **2 - 1 1/2" Finishing Nails**.

<u>Parts</u> Front Middle Trim (1/2" x 2 1/2" x 2 5/8")	<u>Hardware</u> 1 1/2" Finishing Nails x 2 total
--	---

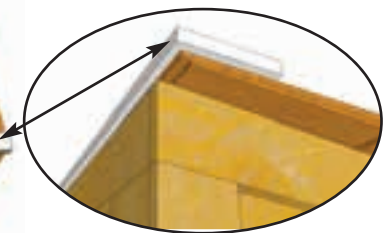
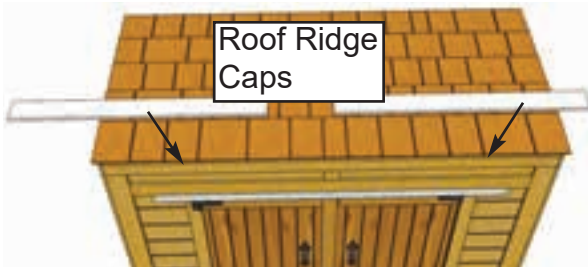

57. Using a Step Ladder, place both **Roof Ridge Caps** on front row of Roof Shingles. Ridge Caps will overhang Shingles by 1/4" at the side and 1/4" at the front. Attach each piece with **4 - 1 1/2" Finishing Nails**.

<u>Parts</u> Roof Ridge Caps (1/2" x 3 1/2" x 39 1/4") x 2	<u>Hardware</u> 1 1/2" Finishing Nails x 8 total
---	---

**Thanks for reviewing the
6x3 Garden Saver**
please email us with any and all questions

Made with North American Western Red Cedar

www.CedarShedAndGardenKits.com info@CedarShedAndGardenKits.com

Note: Our Sheds are shipped as unfinished products. If exposed to the elements, the western red cedar lumber will weather to a silvery-gray color. If you prefer to keep the cedar lumber looking closer to the original color, we suggest that you treat the wood with a good oil base wood stain. You may also wish to paint your new shed rather than stain it. In both cases we recommend that you consult with a paint and stain dealer in your area for their recommendations.



We value your feedback and would like to hear back from you on how well we are doing in the following areas:

- 1. Customer Service**
- 2. On Time Shipping**
- 3. Motor Freight Delivery**
- 4. Quality of Materials**
- 5. Assembly Manual**
- 6. Overall Satisfaction**

The materials contained in this Assembly Manual may be downloaded or copied provided that ALL copies retain the copyright and any other proprietary notices contained on the materials. No material may be modified, edited or taken out of context such that its use creates a false or misleading statement or impression as to the positions, statements or actions.

Please email John and Pat Motley at
info@CedarShedAndGardenKits.com