

Cedar

Shed & Garden Kits

8'x4' GardenSaver

with rear sloping
Cedar Shingle Roof
Double Doors
ASSEMBLY MANUAL

Made with North American Western Red Cedar

www.CedarShedAndGardenKits.com info@CedarShedAndGardenKits.com

**Thanks for your interest in
the 6x4 Garden Saver
Shed ~ John and Pat**

**Delivery is Free from the
Factory to your Home,
Ranch or Business and
Liftgate Delivery is always
included with every order.**

Please review this Assembly Manual and the Spec Sheet thoroughly before ordering. We want you to become familiar with all of the tools required and where and when assistants may be necessary. More than anything we want this to be fun and successful!



- **It is the sole responsibility of the customer to check with your local municipal or county by-laws before ordering this product to confirm it complies with building codes in your area.**
- **If the product is elevated, any structural and building code requirements are solely the customer's responsibility, and should be abided by.**
- **Snow load ratings vary by geographical location. If heavy or wet snowfall occurs, it is advisable to sweep snow off roof frequently.**
- **In areas with high or gusty wind conditions, it is advisable to install the structure securely to the ground.**
- **Have a regular maintenance plan to ensure screws, doors, windows and parts are tightly affixed.**
- **All structures purchased from Outdoor Living Today are covered for a period of one year for defects in manufacturing and workmanship. Costs incurred for customer installations are not included.**
- **Failure to use supplied parts included in this kit could result in poor product performance and may void your warranty. Please contact Outdoor Living Today's Customer Toll Free Line if you plan to deviate from our written instructions.**

Customer agrees to hold OLT Manufacturing and Cedar Shed And Garden Kits LLC Authorized Dealer, free of any liability for improper installation, maintenance and repair.

In the event of missing or broken pieces, please call the Customer Support Line within 30 days of the delivery of your kit. You'll find the number in your Assembly Manual that comes with the kit. It is our commitment to you to deliver replacement parts, free of charge, within 10 business days of your notification. Replacement parts will not be provided free of charge after the 30 day grace period.

What to do before my Shed arrives?



- Become familiar with this assembly manual and determine if you can complete the project yourself or will require a professional contractor.



- One helper is recommended to assist in constructing your shed. It generally takes two people two days to assemble a shed. If you're hiring a contractor, their rate should be in line with that duration of work.



- Clear the construction area and ensure a clear pathway for delivery when the freight company arrives. Remove all debris: roots, grass, rocks, etc.



- Excavate the site. Contact your local utilities company to ensure there are no gas or electric lines buried in the area before digging.

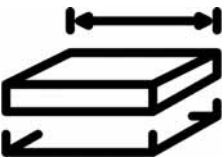

- Decide on the type of foundation you will be using:
 - Concrete slab, or
 - 4-6 inches of crushed gravel with paver stones or 4x4 stringers.

You can find the footprint for your shed on Page 3 of your Assembly Manual.



- If doing the assembly yourself, have all the necessary tools ready to go and in working condition. A list of required tools can be found after the parts list.

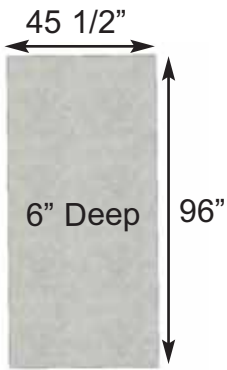

Concrete Foundation

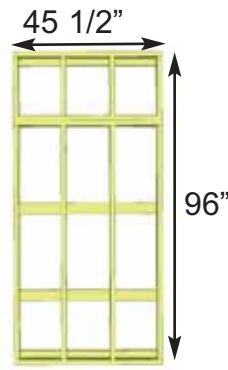

Floor Frame



Completed Foundation

Concrete Slab Foundation:

- Slab must be at least the same size as assembled floor frame (45 1/2" x 96") or larger.
- 6" Deep foundation.
- 0.6 Cubic Yards of concrete required.
- A concrete slab will have the longest durability out of your foundation options.

Once level, a concrete slab is the easiest surface to build on.

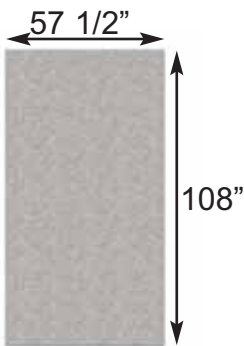

Gravel Foundation

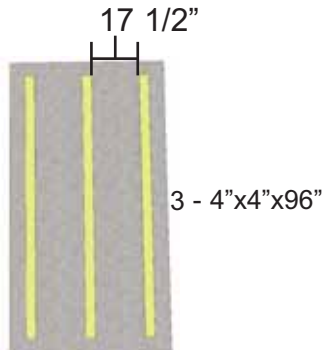

Gravel Foundation with treated stringers



Completed Foundation

Gravel with 4x4 Pressure Treated Stringers:

- Excavate at least 6" deep, and 6" wider than floor frame on each side.
- 1.0 Cubic Yards of gravel required, approximately 9 wheelbarrows.
- 3 - 4x4 Pressure Treated Stringers 8' long required.
- Evenly spaced, with one at each end of floor frame.

Saves money on materials, easy to level and work with.

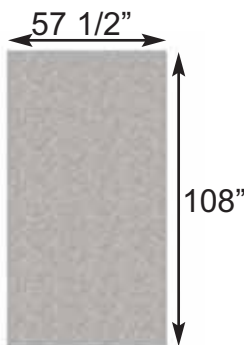

Gravel Foundation

15 Patio Stones



Gravel Foundation with Patio Pavers



Completed Foundation

Gravel with Patio Paver Stones:

- Excavate at least 6" deep, and 6" wider than floor frame on each side.
- 1.0 Cubic Yards of gravel required, approximately 9 wheelbarrows.
- 15 patio pavers (8" x 8" or larger).
- Center patio paver stones underneath floor runners and underneath seams in floor joists.

Patio paver stones are widely available from most landscape stores.

Parts List:

A. Floor Section

- 1 - 45 1/2" x 75" - **Large Floor Frame** (2 Joists unattached)
- 1 - 45 1/2" x 21" - **Small Floor Frame** (2 Joists ATTACHED)
- 2 - 1 1/2" x 3 1/2" x 71 3/4" - **Floor Joists**
(Steps 1 - 2)
- 5 - 1 1/2" x 3 1/2" x 45 1/2" - **Floor Runners**
(Steps 3 - 5)
- 1 - 5/8" x 45 1/2" x 75" - **Plywood Flooring**
- 1 - 5/8" x 45 1/2" x 21" - **Plywood Flooring**
(Steps 6 - 8)

B. Wall Section

- 4 - 1 1/2" x 2 1/2" x 45 1/2" - **Wall Plates**
- 4 - 45 1/2" x 75" - **Wall Panels**
- 2 - 12" x 73" - **Narrow Wall Panels**
(Steps 9 - 18)
- 2 - 2" x 3 1/2" x 6 1/2" - **Door Headers - Short (Dado on edge)**
- 1 - 2" x 3 1/2" x 78" - **Door Header - Long**
Dado cut on edge- Aluminum Support Strip Attached
- 2 - 1 1/2" x 3 1/2" x 73" - **Door Jambs - Vertical**
(Steps 19 - 21)
- 2 - **Top Triangular Siding Pc for Angle Wall Extenders (L/R)**
- 2 - 45 1/4" - **Angle Wall Extenders (L/R)**
- 2 - 9" x 45 1/2" - **Wall Extenders**
(Steps 22 - 28)
- 1 - 3/4" x 3 1/2" x 70" - **Horizontal Wall Cleat**
- 1 - 3/4" x 3 1/2" x 21" - **Horizontal Wall Cleat**
(Step 29)

C. Rafter & Roof Section

- 6 - 1 1/2" x 2 1/2" x 54" - **Rafters**
- 2 - 1/2" x 3 1/2" x 48" - **Front Soffits**
- 2 - 1/2" x 3 1/2" x 48" - **Rear Soffits**
(Steps 31 - 36)
- 2 - **Rafter/Facia Nailing Plates** - 3/4" x 3/4" x 51"
(Step 37)
- 2 - **Roof Panels** - 51" w x 56" d (1 - Left 1- Right)
(Steps 38 - 40)
- 4 - 5 1/2" Wide x 16" to 18" long - **Filler Shingles**
(Steps 41 - 44)

D. Miscellaneous Section

(Skirting, Trim, Door, Facia & Misc. Parts)

- 6 - 3/4" x 4 1/2" x 45 1/4" - **Bottom Skirting** (Bevel Siding)
(Steps 47 - 50)
- 8 - 7/8" x 2 1/2" x 36" - **Corner Filler Trims**
- 2 - 7/8" x 2 1/2" x 10" - **Front Center Corner Filler Trims**
(Steps 51 - 53)
- 2 - 1/2" x 3 1/2" x 77 1/2" - **Vertical Door Trims**
(Steps 54 - 55)
- 2 - 1/2" x 5 1/2" x 79" - **Rear Corner Trims**
- 2 - 1/2" x 5 1/2" x 88 3/4" - **Front Corner Trims**
- 2 - 1/2" x 2 1/2" x 80" - **Side Rear Corner Trims**
- 1 - 1/2" x 2 1/2" x 79" - **Rear Middle Trim**
- 2 - 1/2" x 2 1/2" x 88 3/4" - **Side Front Corner Trims**
(Steps 56 - 59)
- 1 - 1/2" x 2 1/2" x 88 1/4" - **Horizontal Door Trim**
- 1 - 1/2" x 2 1/2" x 8 5/8" - **Front Middle Trim**
(Step 60)
- 2 - 31 1/2" x 72" - **Full Doors**
(Steps 61 - 65)
- 2 - 1/2" x 4" x 54 1/8" - **Side Facia** (Angle Cut Ends) - reverse
- 4 - 1/2" x 4" x 50 1/2" - **Front and Rear Facia**
(Steps 66 - 68)
- 2 - 1/2" x 4 1/2" x 51 5/8" - **Roof Ridge Boards**
(Step 69)
- 2 - **Detail Facia Plates** (4" high)
(Step 70)
- 2 - 1/2" x 1/2" x 28 7/8" - **Upper Interior Door Trims**
- 4 - 1/2" x 1/2" x 35 7/8" - **Side Interior Door Trims**
(Steps 71 - 72)
- 1 - 1 1/2" x 2 1/2" x 6" - **Upper Door Stop**
- 1 - 3/4" x 2 1/2" x 64" - **Lower Door Stop /Floor Threshold**
(Steps 73 - 74)
- 1 - 1/2" x 2 1/2" x 70" - **Interior Vertical Door Flange**
(Steps 75 - 76)
- 1 - 45 1/4" - **Extra Piece of Bevel Wall Siding** - Use if wall panel siding is damaged or to shim floor or door.

Note: All Trim, Facia and Bottom Skirting pieces will be positioned rough face out when installed.

8x4 GardenSaver DD HARDWARE PACKAGE

Hardware Kit (Provided)

3"  7 Pcs.

2 1/2"  161 Pcs.

1 1/2"  245 Pcs.
Finishing Nail

1 1/4"  115 Pcs.

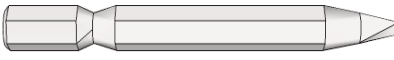
Square Drive Bit

2"  38 Pcs.
Black Headed

3/4"  24 Pcs.
Black Headed

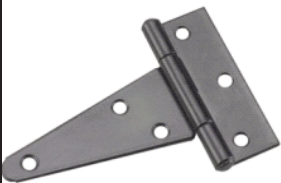

Tee Hinge x 6



Door Handle x 2



Drop Latch



Cane Bolt



90° Metal Bracket x 8

Tools Required (Not Provided)



Hammer



Screw Gun/Drill x 2



Tape Measure



Wood Clamp



Utility Knife



Level



Pliers



Ladder



1/8" & 1/2" Drill Bits

Safety Equipment Required (Not Provided)



Safety Glasses



Work Gloves

Regular Maintenance & Tips to prolong the life of your shed.

Before/During Assembly:

- 1.) Paint each face and edge of your plywood floor with a latex exterior paint.
- 2.) Caulk wall seams if gaps appear.
- 3.) Caulk around window framing.
- 4.) Caulk perimeter between floor plywood and bottom wall plate.
- 5.) Caulk channels in lap siding at the top of your door above the trim, just a drop in each channel.
- 6.) Caulk edge of door threshold (if applicable).
- 7.) Optional: Install a Sill Gasket between floor runners and foundation.
- 8.) Optional: Install an 8" strip of roofing paper below Cedar Ridge Caps for Cedar Roof Sheds.

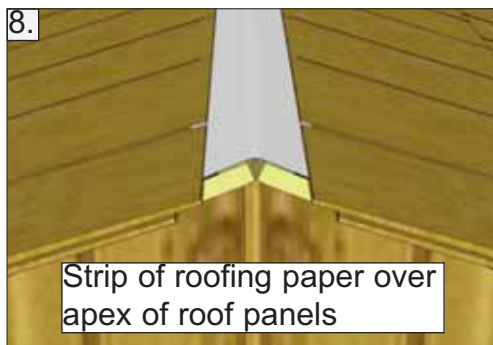
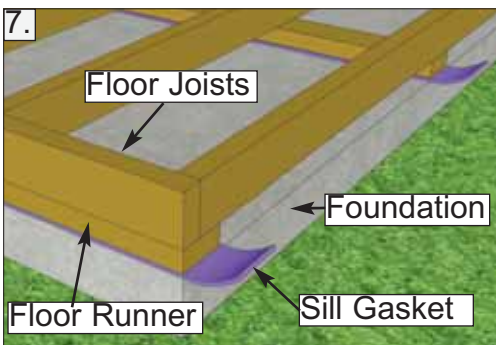
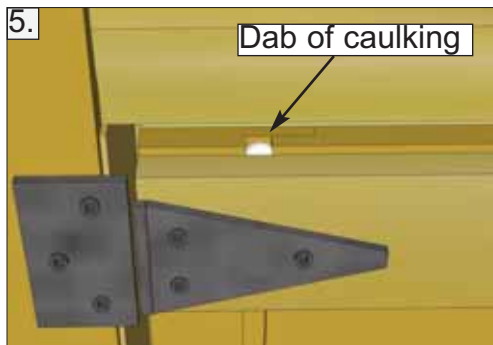
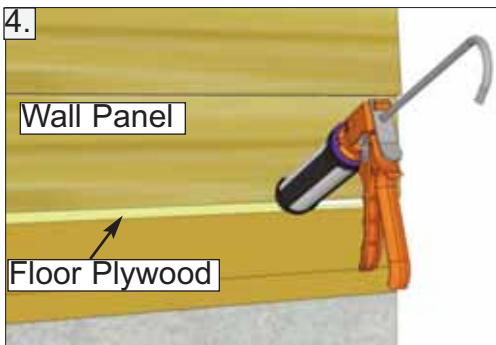
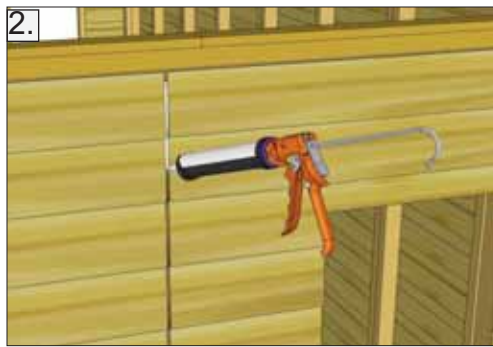
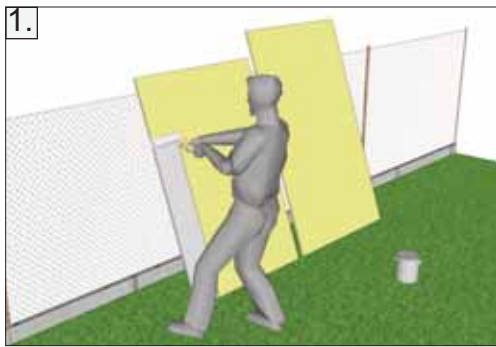

Routine Maintenance:

- Routinely check all fasteners are tight (ex. Door Hinges, Nails)
- Brush off dirt from walls.
- Brush off snow from roof regularly.
- Routinely remove needles and leaves from roof.

Painting/Staining

- Your cedar shed, if left untreated, will weather to a silvery grey colour.
- Painting or staining your structure is highly recommended and will prolong the life of your shed.
- You do not need to wait to paint or stain your shed, the wood in your kit has been dried and can be stained or painted immediately.
- Consult your local paint store for the best paint or stain for cedar.
- Optional: stain the inside of your shed. (Note: this will remove the fresh cedar smell.)

A. Floor Section

Exploded view of all parts necessary to complete Floor Section. Identify all parts prior to starting. Note: Floor Footprint is 96" wide x 45 1/2" deep.

Exploded Floor Section

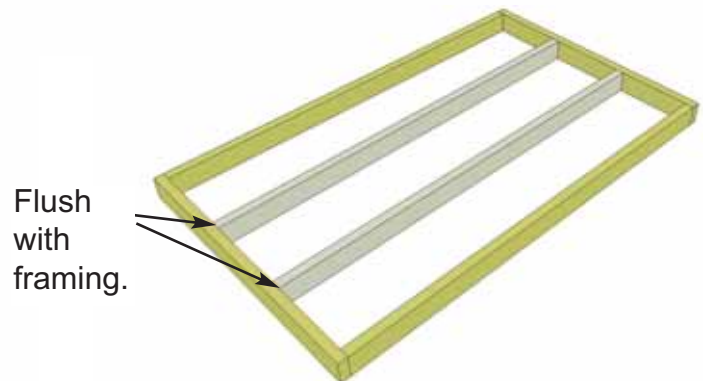
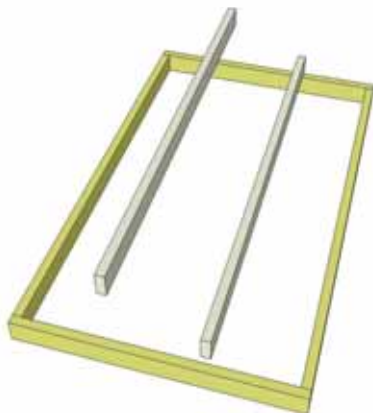
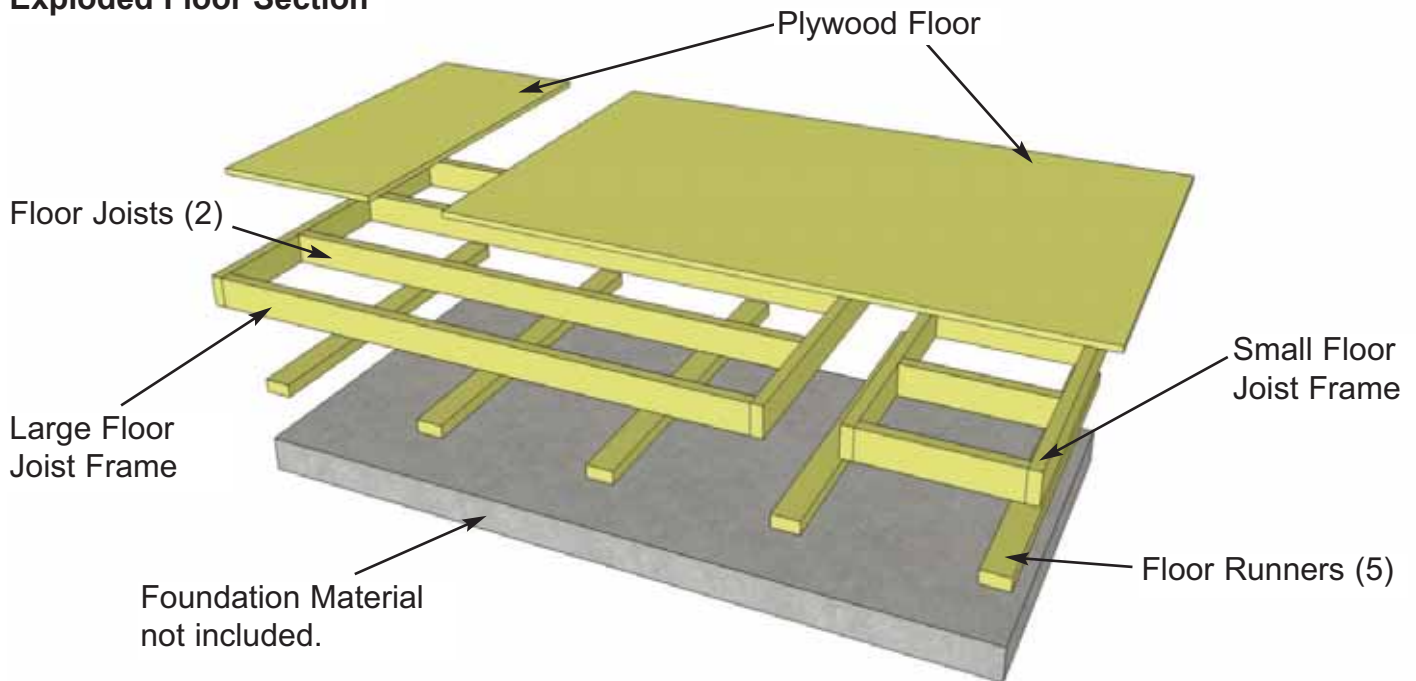

1. Lay out **Large Floor Joist Frame** and **2 Floor Joists** (1 1/2" x 3 1/2" x 72") as illustrated above. Position Joists equally in Floor Joist Frame. Use **Small Floor Joist Frame** as a template to determine joist position. Position Joist so flush with framing.

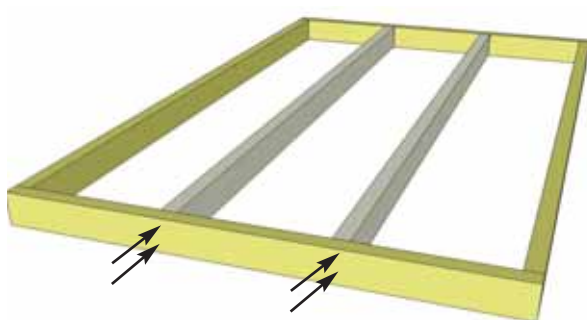

You can find the Square Drive Bit, for the screws, in the Hardware Kit Bag.

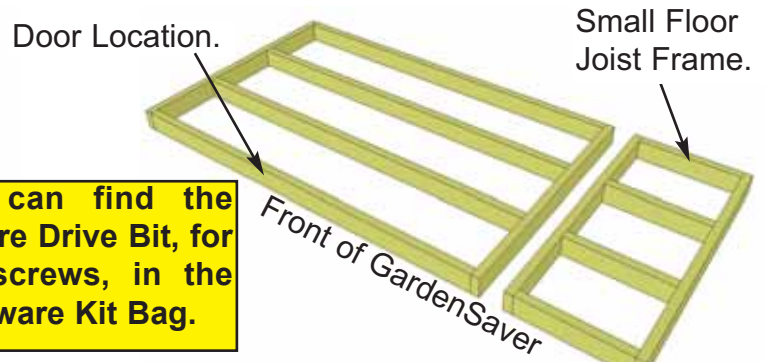

2. When correctly positioned, attach each Joist with 4 - 2 1/2" screws (2 per end). **You can find the Square Drive Bit for the screws in with the Hardware Kit Bag.**

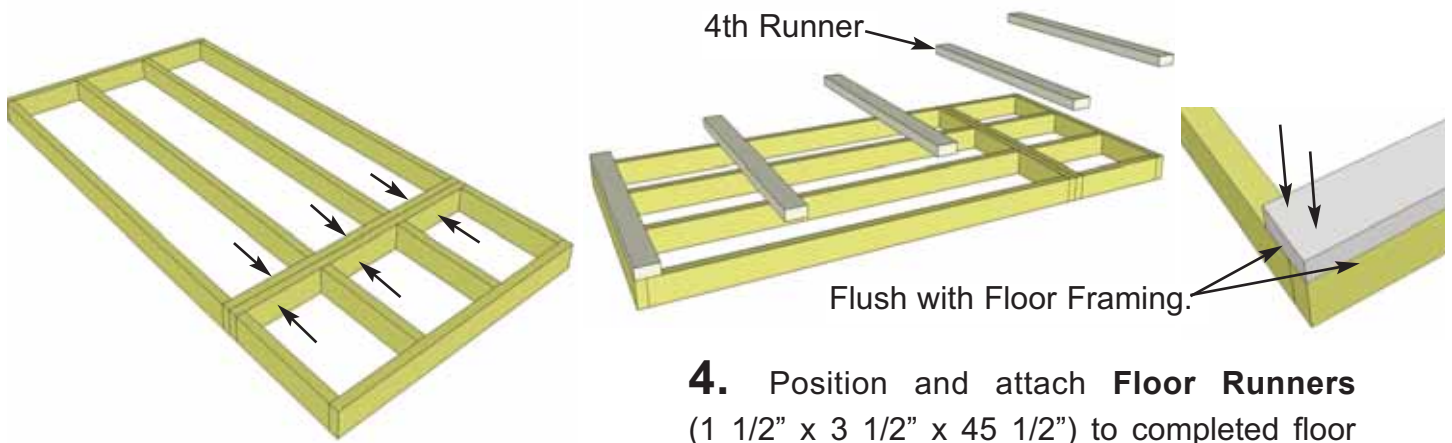

3. With Floor Joist Frames positioned together flush, attach with 6 - 2 1/2" screws.

4. Position and attach **Floor Runners** (1 1/2" x 3 1/2" x 45 1/2") to completed floor frames with 6 - 2 1/2" screws per Runner. Make sure Runners are flush with outside of floor framing but not overhanging. Make sure 4th Runner is placed equally over seam where floor frames meet.

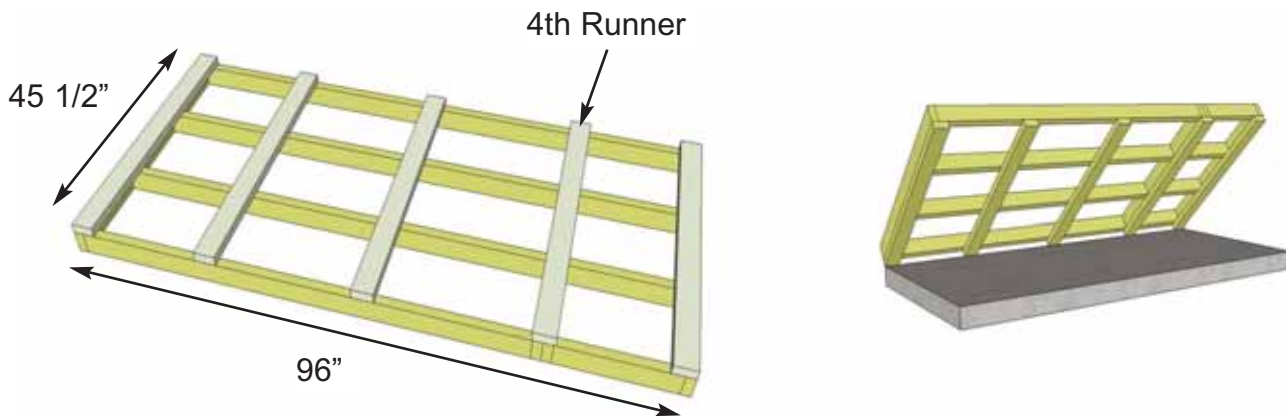

5. With Floor Runners attached, carefully flip the floor over and place on your foundation. **Caution** - you may need 2 people to assist you. Be careful when laying floor down not to bend or twist floor. **Note:** The floor will be flipped over and floor runners will sit on your foundation. It is important to note that having a level foundation is critical. Choosing a foundation will vary between regions. Typical foundations can be concrete pads or patio stones positioned underneath the floor runners.

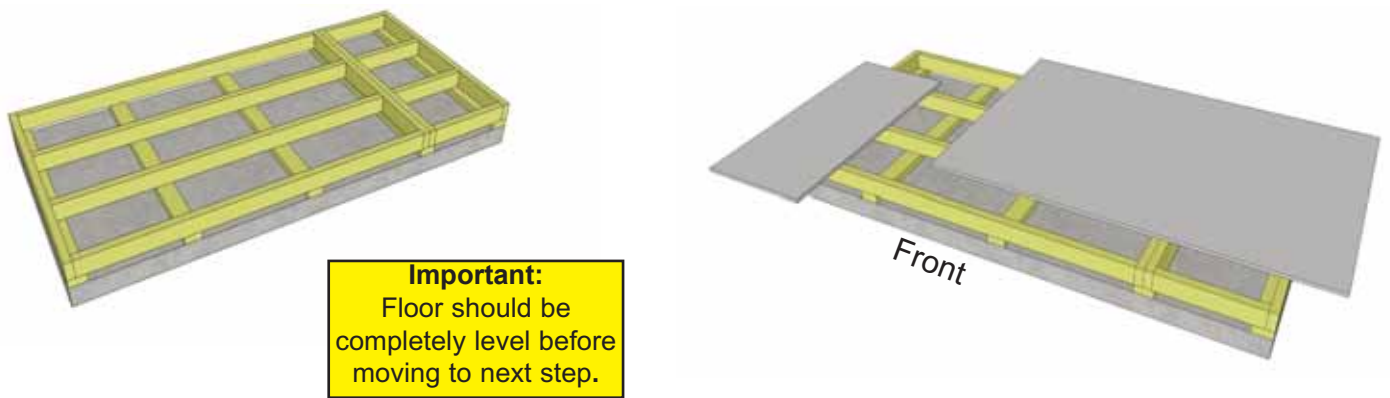

6. When in place, level floor completely before proceeding.

7. Position **Plywood Floor** pieces (2) on top of completed floor joists.

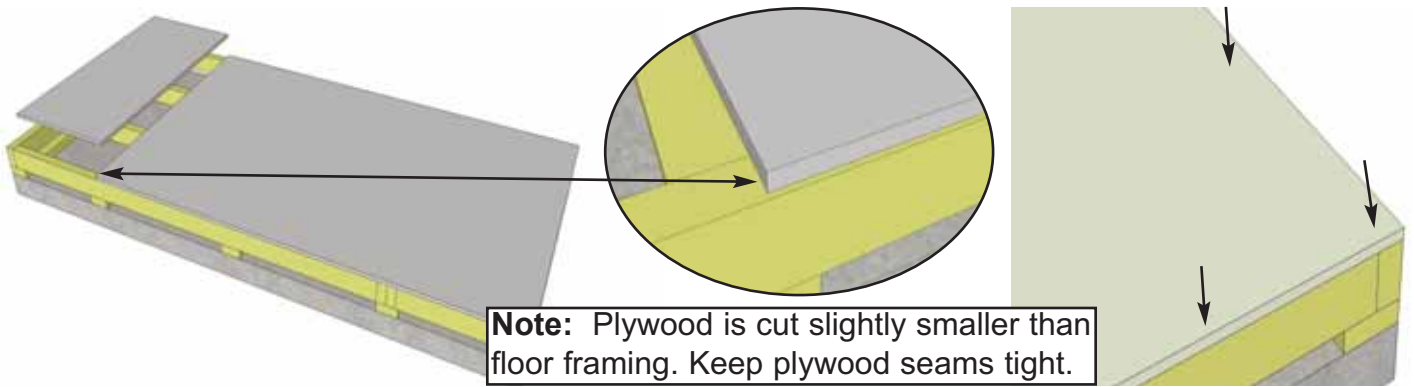

8. Position Plywood so it sits almost flush with outside of floor joist framing (see **Note**). When correctly positioned, attach to all floor joists with 1 1/4" screws. Use screws every 16".

B. Wall Section

Exploded view of all parts necessary to complete the Wall Section. Identify all parts prior to starting.

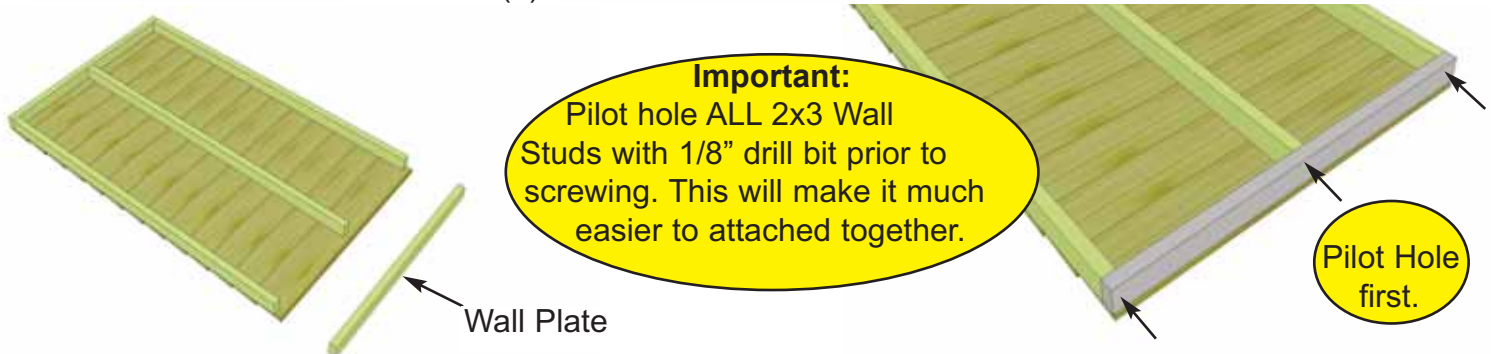
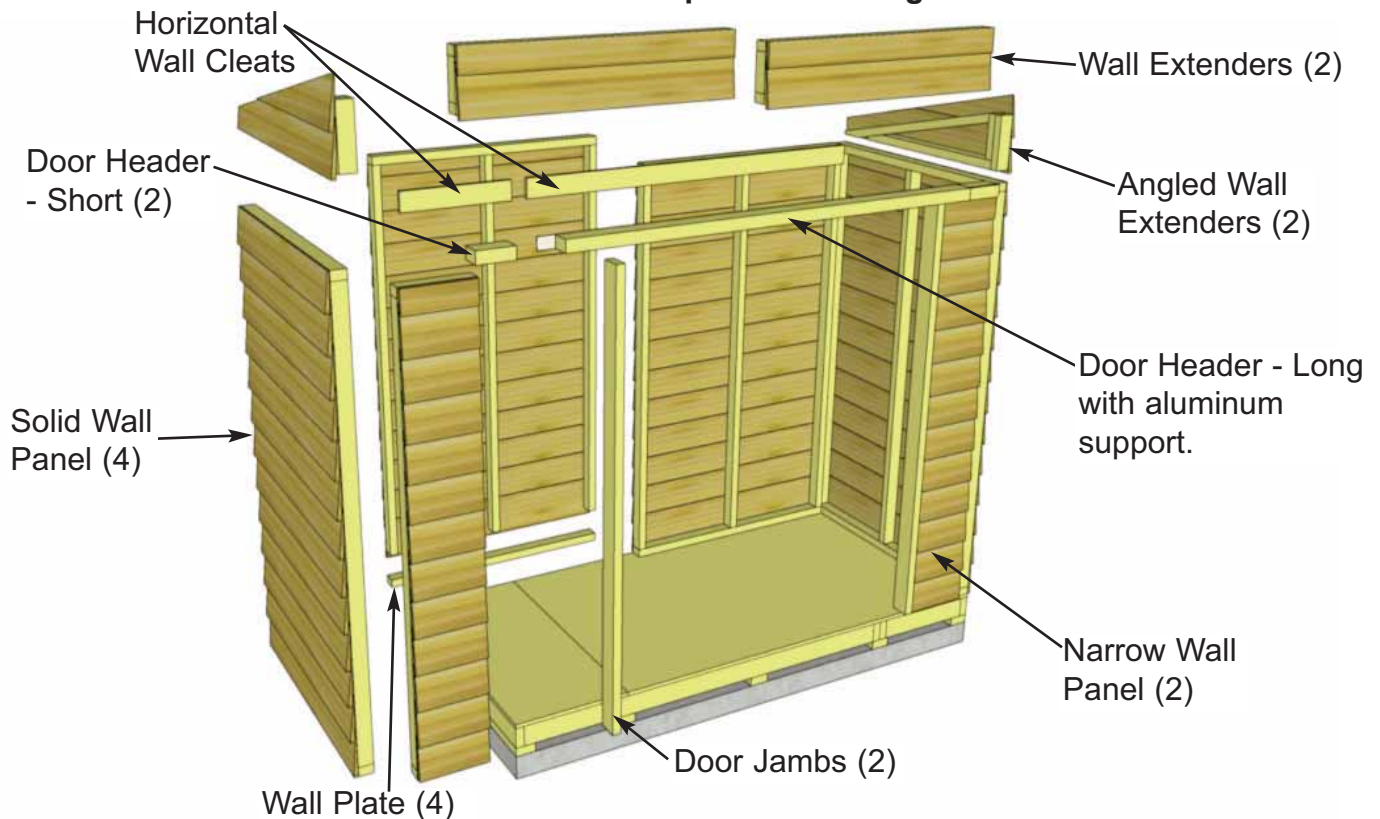

9. Locate 4 **Solid Wall Panels** and 4 **Wall Plates** (1 1/2" x 2 1/2" x 45 1/2"). Attach Plates to bottom of studs of each wall panel with 3 - 2 1/2" screws. Position so plates are flush with framing.

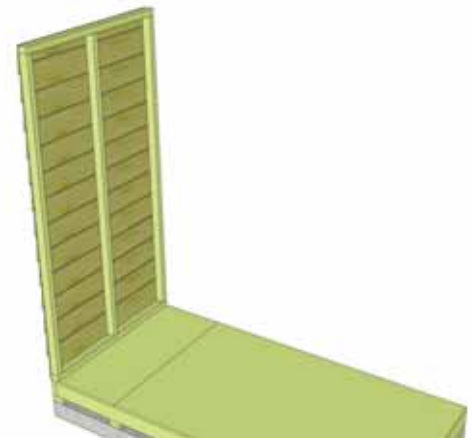

10. Starting on side, position a **Solid Wall Panel** on top of plywood floor. The Wall Panel bottom framing will sit flush with floor framing. Wall siding will overhang the floor. **Important:** Make sure all walls are aligned in their upright position. If not, water may leak into your shed. Unsure if panel is facing up or down? Recently attached Bottom Plate is on bottom of panel.

Do not align wall siding to floor. Align wall plate to outside of plywood floor.

Wall Plate Flush with plywood floor.

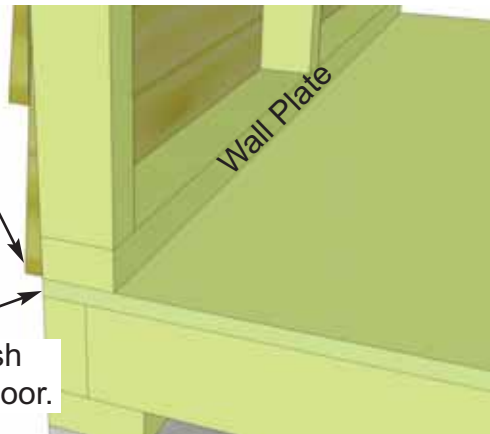

11. Outside 2x3 framing of wall panel should be flush with outside of floor framing when properly aligned. **Note:** Do not align wall siding to floor. Align wall plate to outside of plywood floor. When positioned correctly, locate 2nd Solid Wall Panel and place in corner.

Do Not Attach Walls To Floor until Step 30.

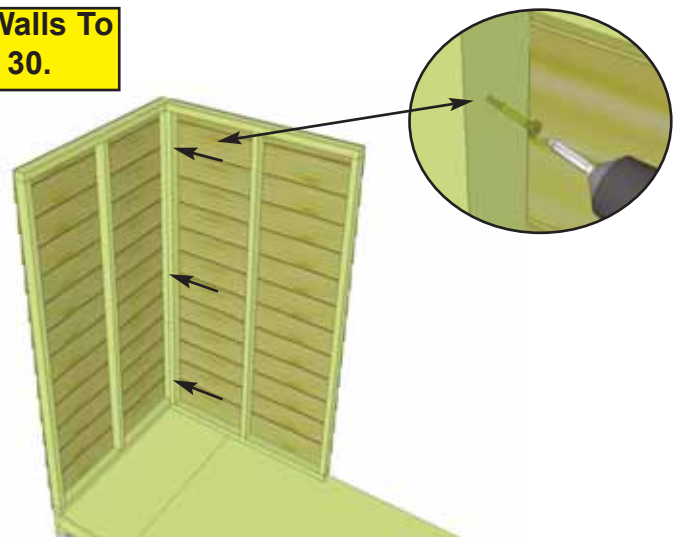

12. Butt both vertical wall studs of side and rear walls together and attach with 3 - 2 1/2" screws. Screw at the bottom, middle and top of stud to secure properly. Have helper push wall framing together while securing to ensure tight fit.



13. With the corner wall attachment complete, position the second rear wall panel in place so bottom 2x3 wall framing is sitting flush with outside floor framing. Wall siding should overhang floor by approximately 3/4". When positioned correctly, attach both wall panel studs together as per **Step 12** with 3 - 2 1/2" screws.

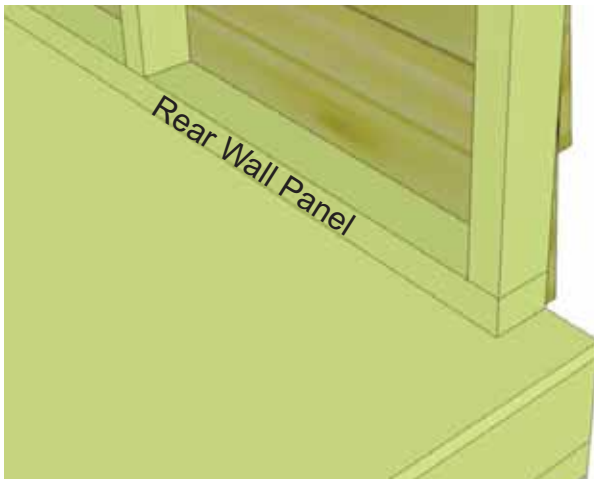

Do Not Attach Walls To Floor until Step 30.



14. With Rear Wall Panel in place, position other side wall panel on floor as per **Step 10 & 11**.

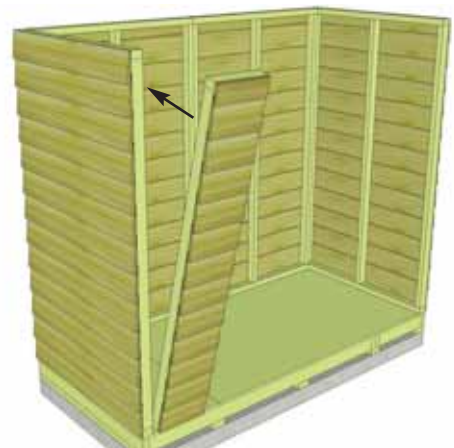
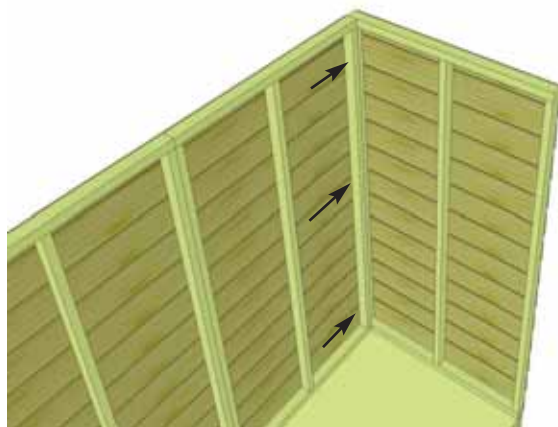

15. Secure side wall panel to rear wall panel as per **Step 12**. Next, locate a **Narrow Wall Panel** and position in front corner.

2x3 wall plate flush with plywood floor.

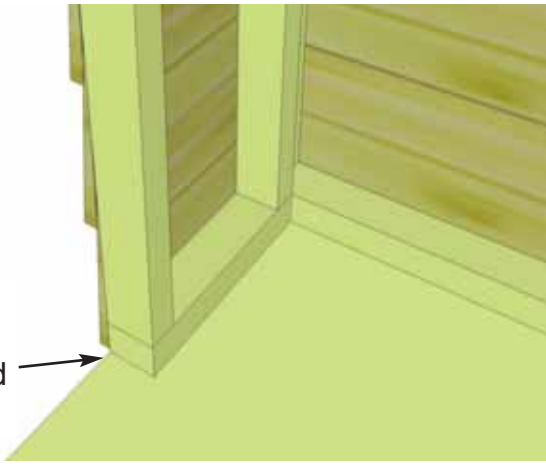

16. Once again position the 2x3 wall plate so it sits flush on floor and siding overhangs.
Note: Narrow Wall Panel is only 73" high.

17. When correctly positioned, secure Narrow Wall Stud to Side Wall Stud with 3 - 2 1/2" screws.

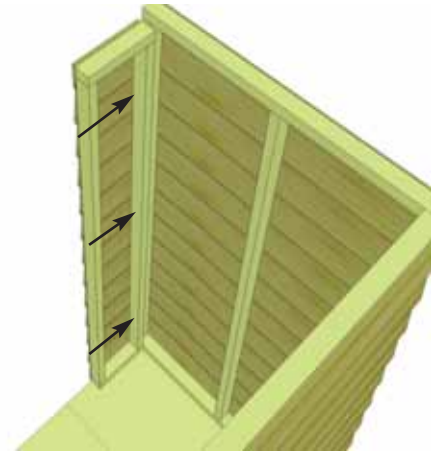

18. Complete opposite Narrow Wall as per **Steps 16 & 17.**

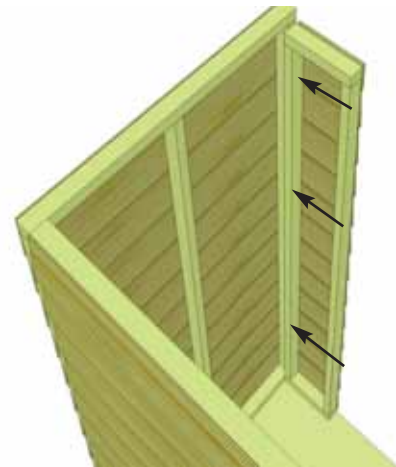

Step to front and top.

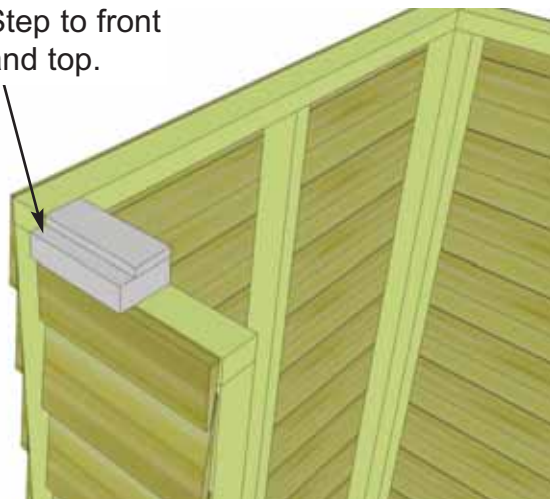

Align with inside wall framing.

19. Locate both **Door Headers - Short** (step facing up and out). Attach both short end pieces using 2 - 2 1/2" screws per piece. Screw from top down into wall framing. Align to inside of wall framing and tight against side wall.

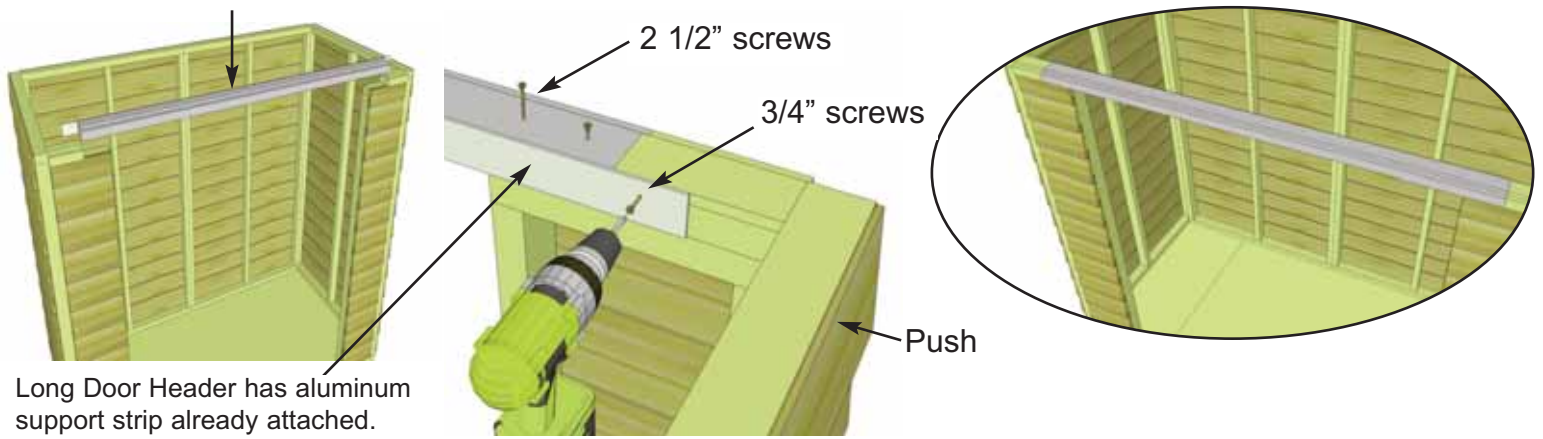

Long Door Header has aluminum support strip already attached.

20. Locate **Door Header - Long** (2" wide aluminum support attached already). Align step on header facing up and out and with support strip to the inside of shed. Attach using 2 - 2 1/2" screws per end as shown above. **Hint:** Have 2 helpers push Side Walls together to close any gaps between Headers. Complete both sides. Attach support strip to short headers with 2 - 3/4" screws.

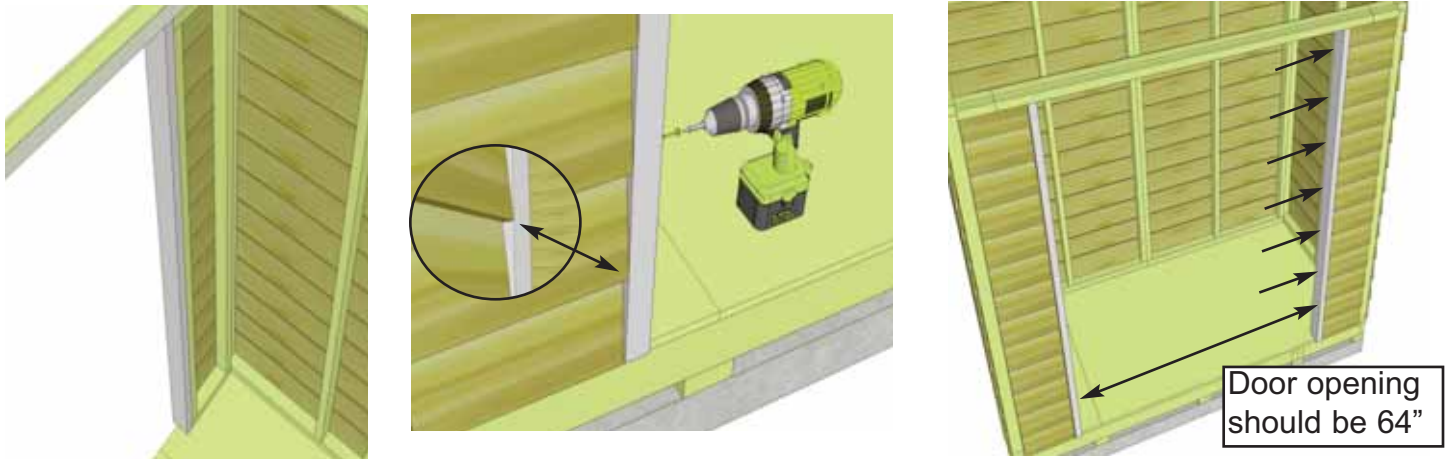

21. Locate both **Vertical Door Jambs** (1 1/2" x 3 1/2" x 73") and position flush against front narrow wall stud. The Jamb will sit flush to outside of wall siding. When positioned correctly, secure Jamb using 6 - 2 1/2" screws. Complete both sides. With both door jambs secured, confirm 64" door opening.

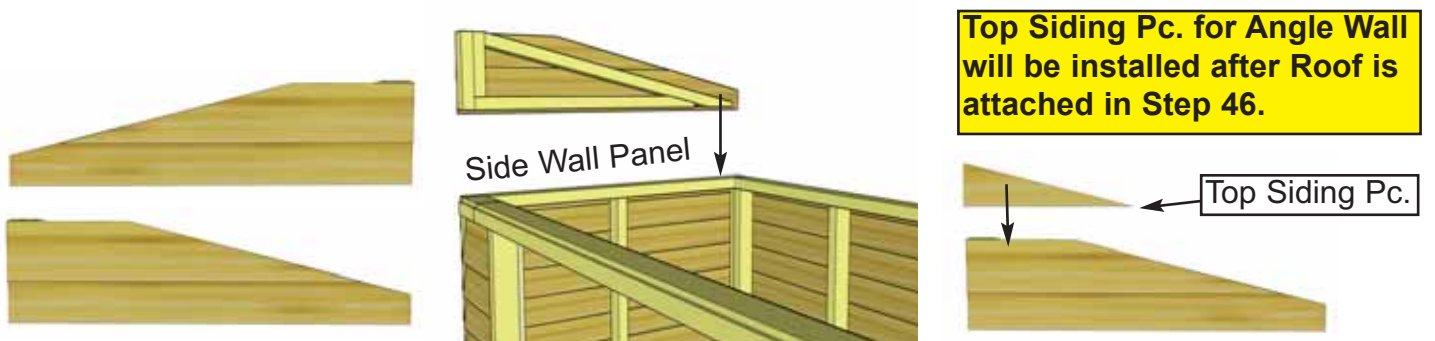

22. Locate both **Angled Wall Extenders (L/R)**. Place first wall extender on side wall panel frame. **Note:** Bottom siding of wall extender will overhang and cover siding of side wall.

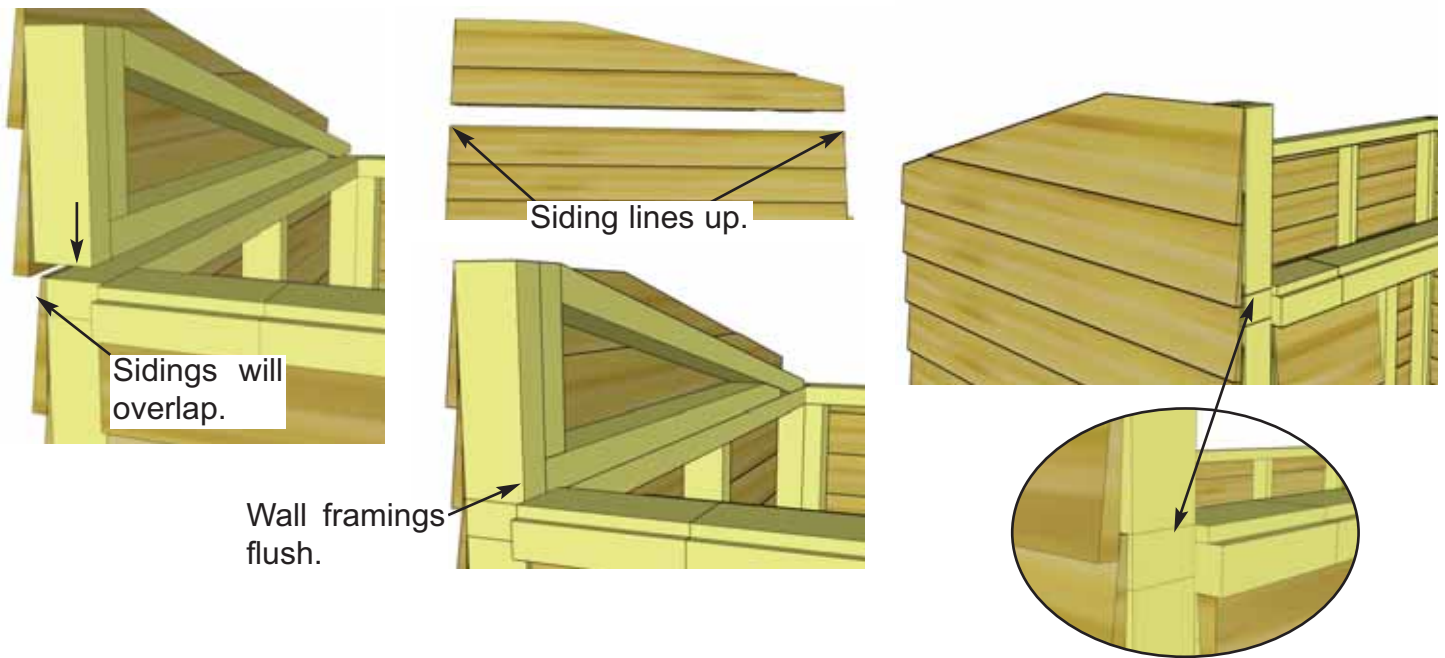

23. Align wall framing of Angled Wall Extender and Side Wall so they are flush at the front. The siding for both walls should also align evenly from front to back.



24. With Angled Wall Extender and Side Wall aligned correctly, secure together from the inside with 4 - 2 1/2" screws.

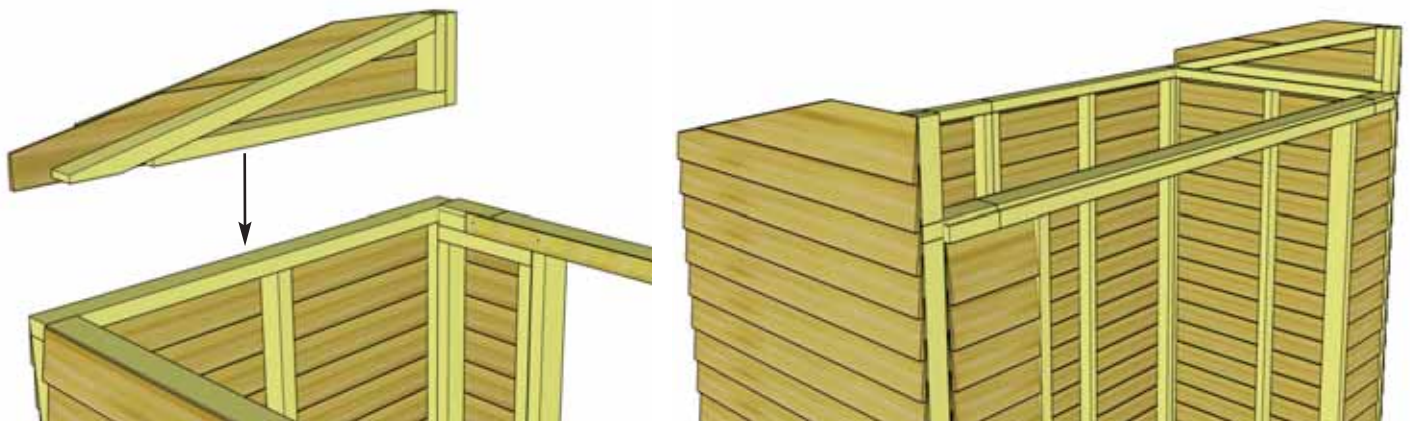

25. Complete opposite Angled Wall Extender positioning and attachment as per **Steps 23 & 24.**

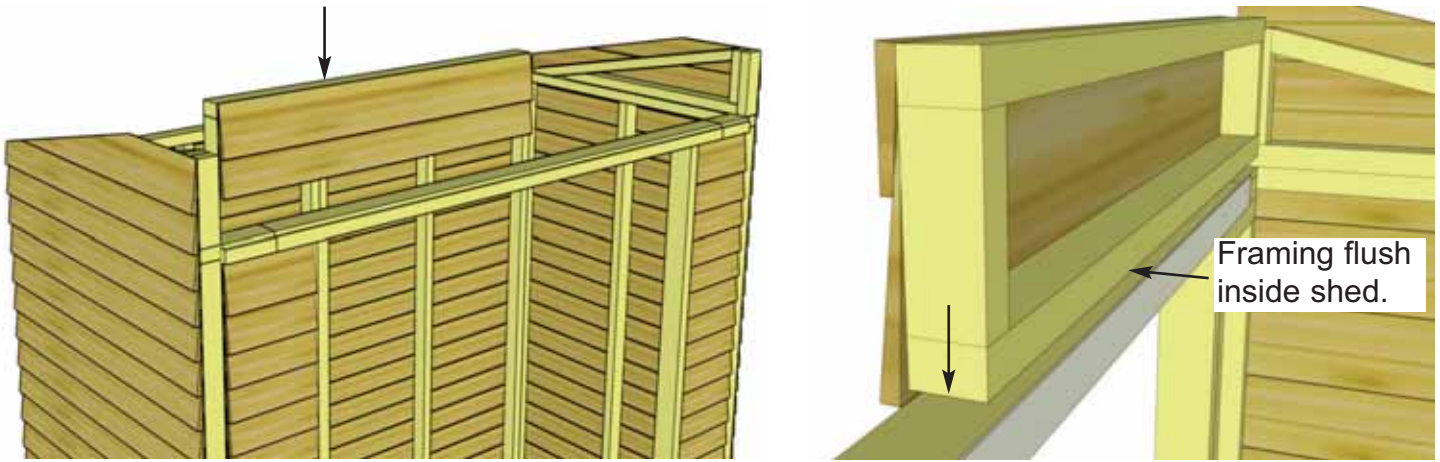

26. Locate one **Wall Extender** and place on Door Header with extender framing flush with inside edge of Header. Overhanging siding on front of extender will rest in notch of Header.

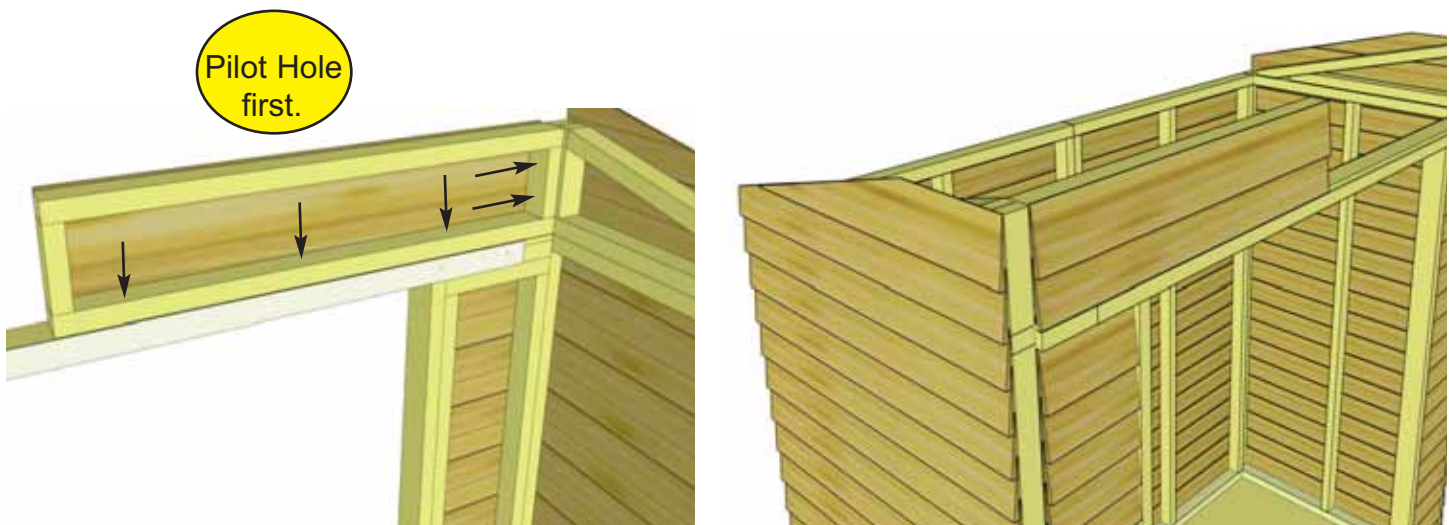

27. Attach Wall Extender to both the Angled Wall Extender framing and the Door Header with 5 - 2 1/2" screws.

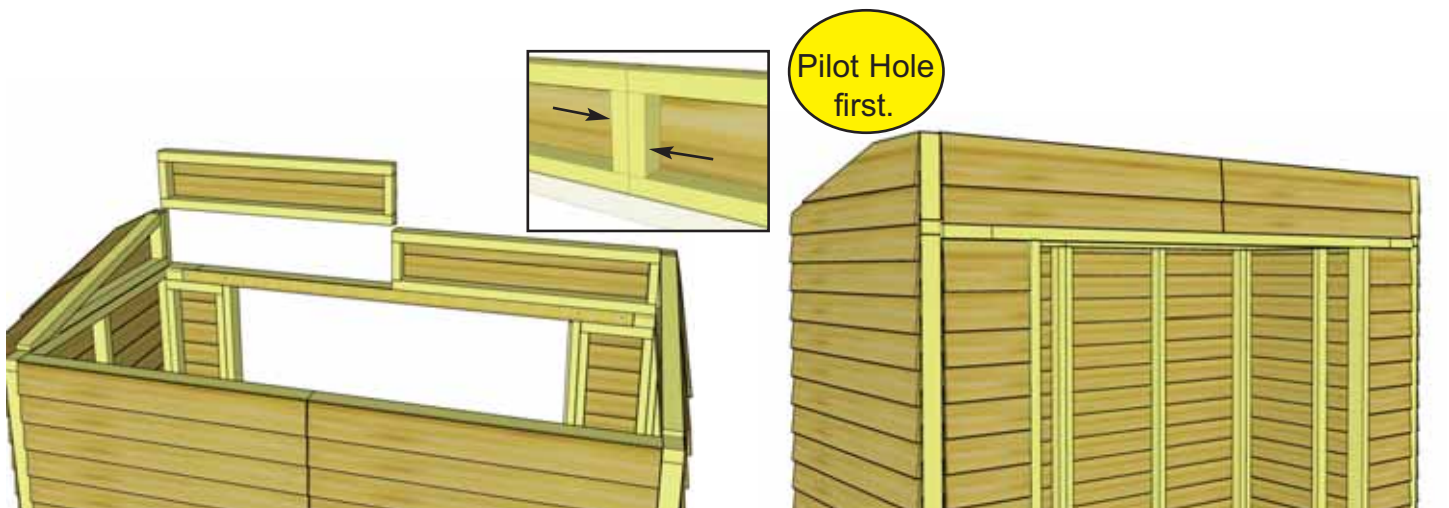

28. Position and secure 2nd Wall Extender Panel as per **Steps 26 & 27**. Additionally, attach to first Extender with 2 - 2 1/2" screws.

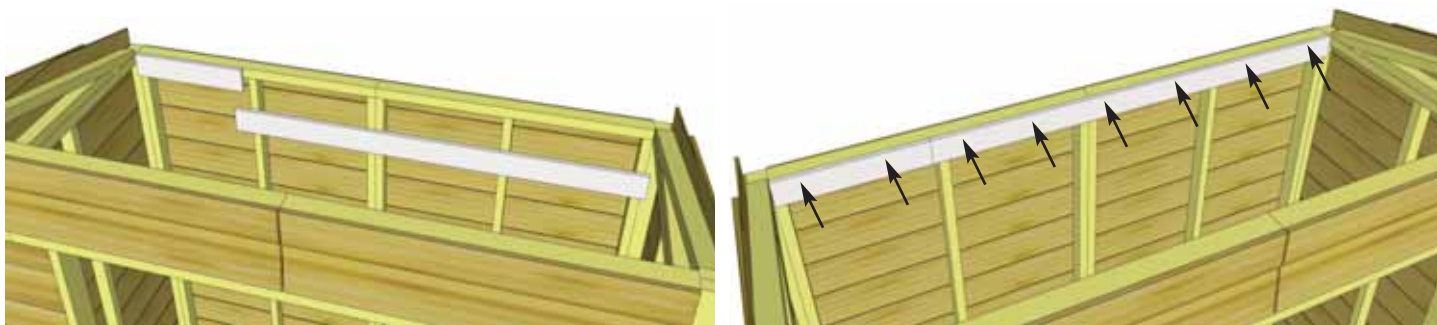

29. Align **Horizontal Wall Cleats** (1 @ 3/4" x 3 1/2" x 70", 1 @ 3/4" x 3 1/2" x 21") flush with top of Rear Wall framing. To help strengthen the Rear Walls, there is a short and a long wall cleat which meet off-center from the seam between walls. Attach Cleats with 8 - 1 1/4" screws.

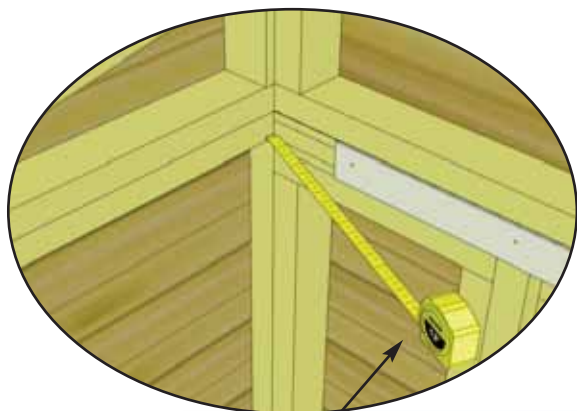

Advice: Prior to fastening walls and installing rafters, take time to confirm your walls are level, square and plumb.

Measure diagonal at top and bottom of walls corner-to-corner. This should be approximately 99 1/4". More importantly, if measurements are not within 1/4", your walls are not square. Adjusting now will make it easier to install roof section.

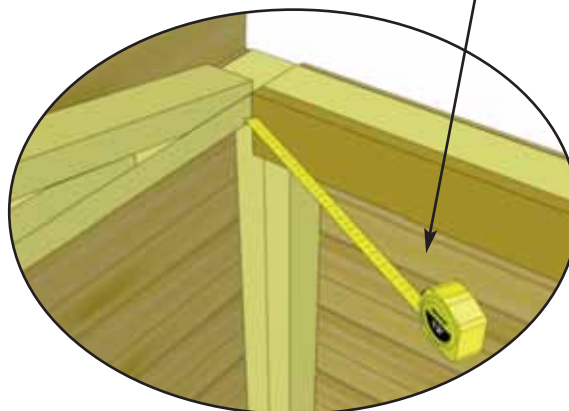
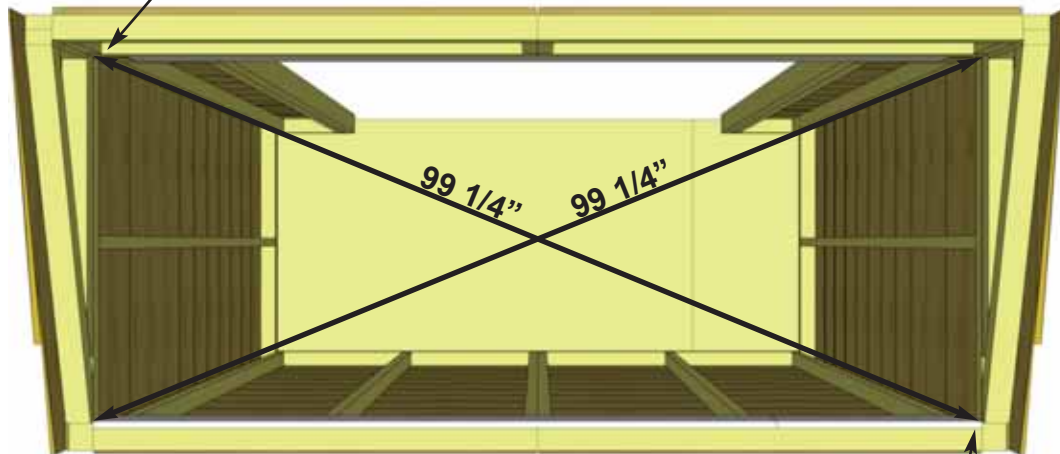

30. To complete Wall Section, attach bottom 2x3 wall plates to plywood floor with 20 - 2 1/2" screws. Confirm Doorway opening is 64" wide. Prior to securing, make sure wall panels are aligned correctly on the floor. Refer to **Step 11**. Wall siding should overhang floor while 2x3 wall plates should sit flush with floor.

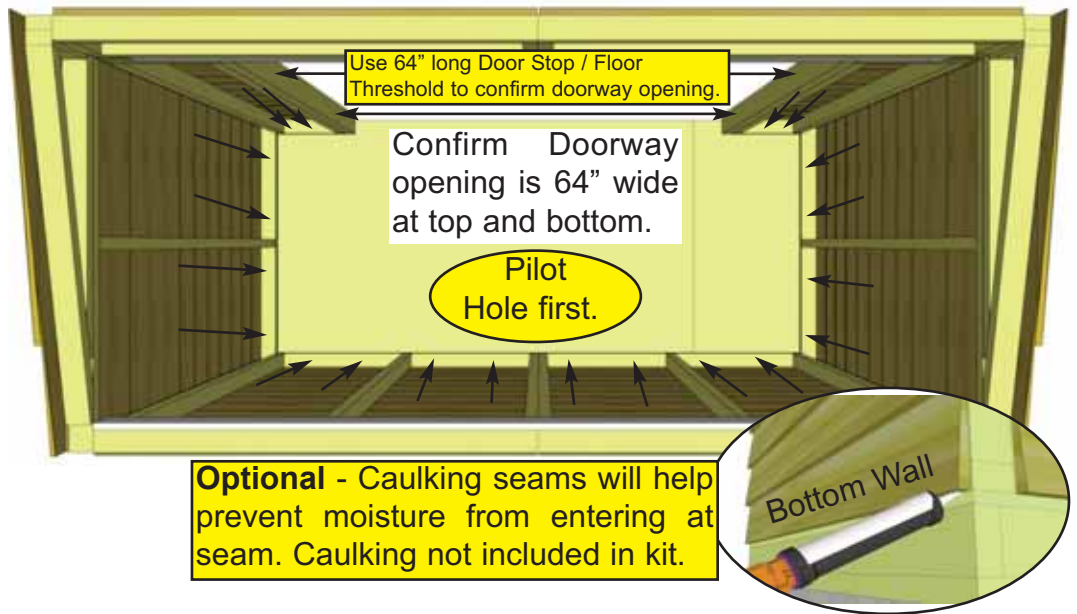

C. Rafter and Roof Section

Exploded view of all parts necessary to complete the Rafter and Roof Section. Identify all parts prior to starting.

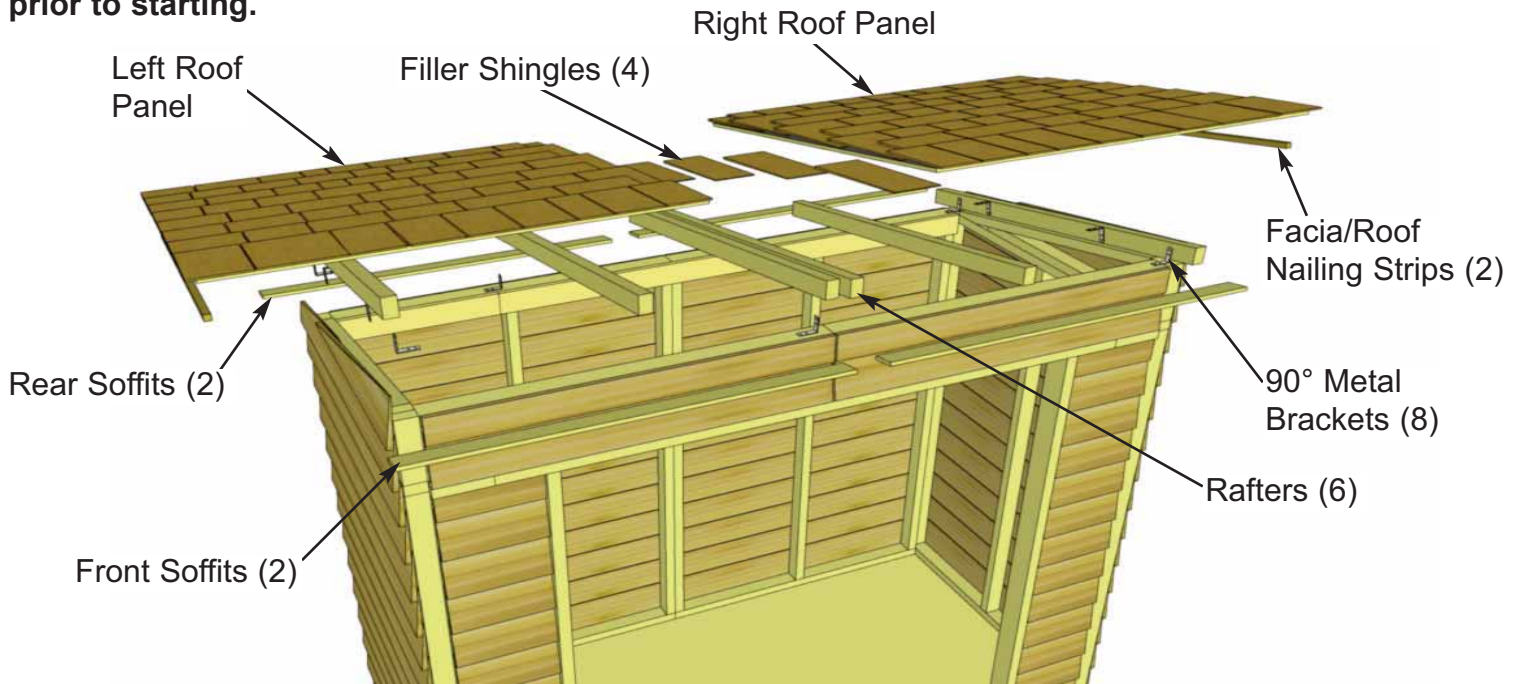

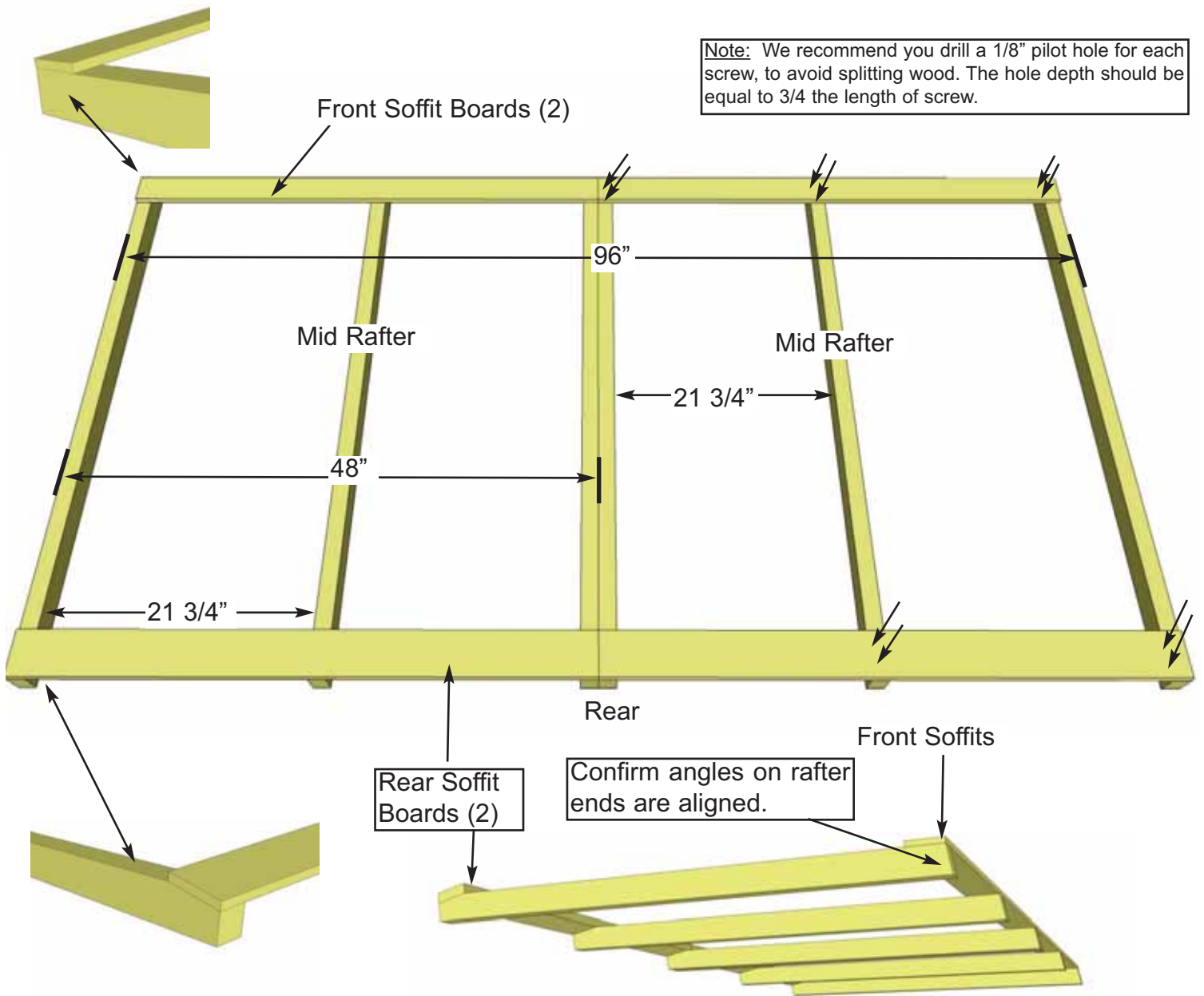

31. Locate 6 **Rafters**, 2 **Rear Soffits** and 2 **Front Soffits**. Lay out on level ground and assemble as shown in Illustrations **A** through **C** below. Attach Soffit Boards flush to end of outside rafters with 2 - 1 1/4" screws per rafter end. **Important:** Drill pilot holes in Soffit ends to prevent splitting. Measure and attach interior Rafters as illustrated above. Measure and attach remaining Soffit/Rafter connections using 2 - 1 1/4" screws per rafter/soffit.

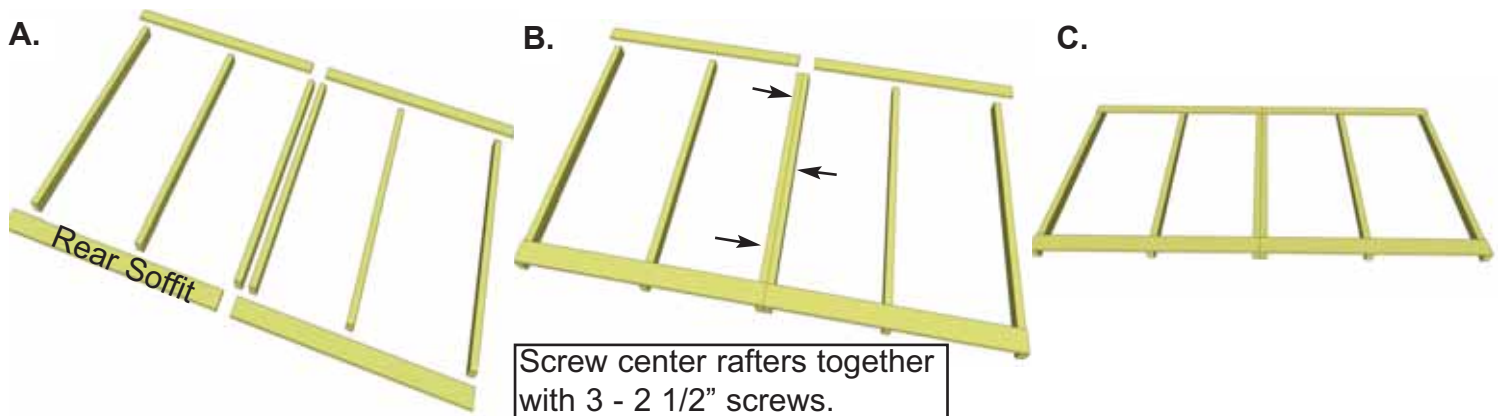

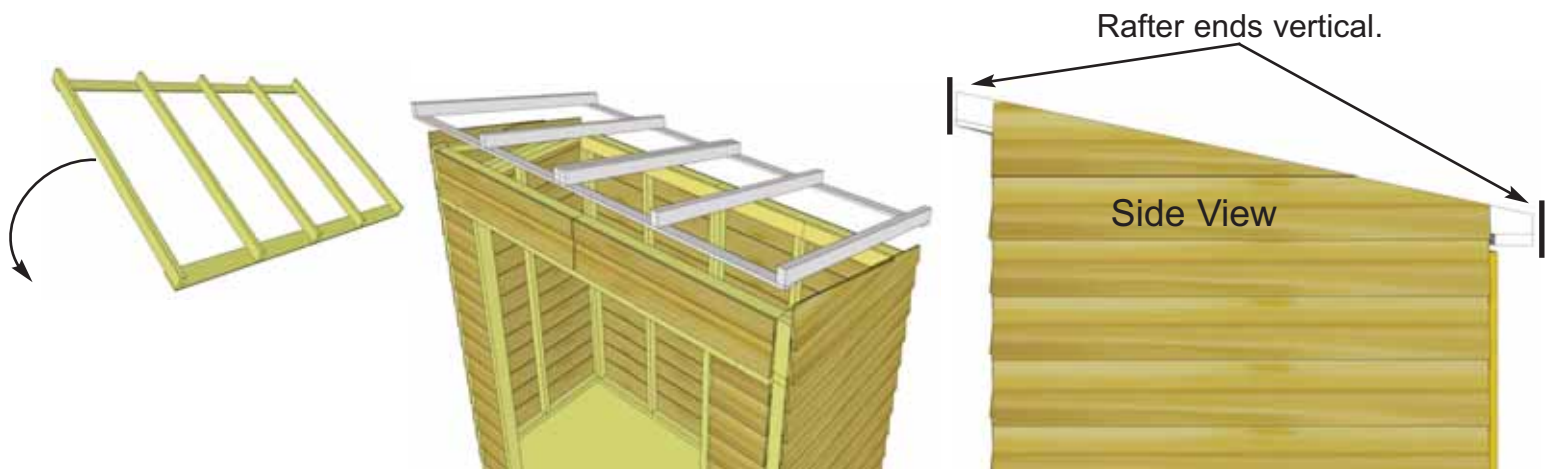

32. Carefully flip completed Rafter Section over so Front Soffit is facing the front and place on GardenSaver walls. **Note:** Double check that your Rafter Section is positioned correctly by ensuring the ends of the Rafters are sloped vertically as shown above.

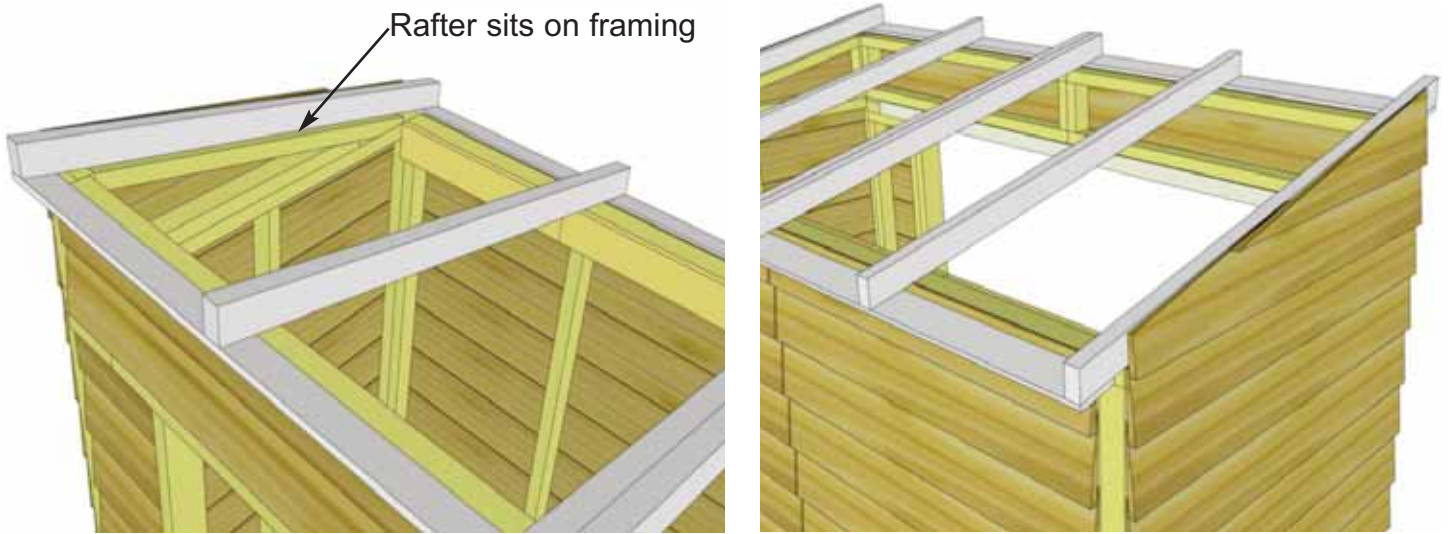

33. Position completed Rafter Section on top of walls. Outside Rafters will sit on Extension Wall framing and be positioned equally from side to side.



34. When Rafter Section is positioned correctly, both Front and Rear Soffits will sit approximately 1/8" away from wall siding. This can vary slightly.

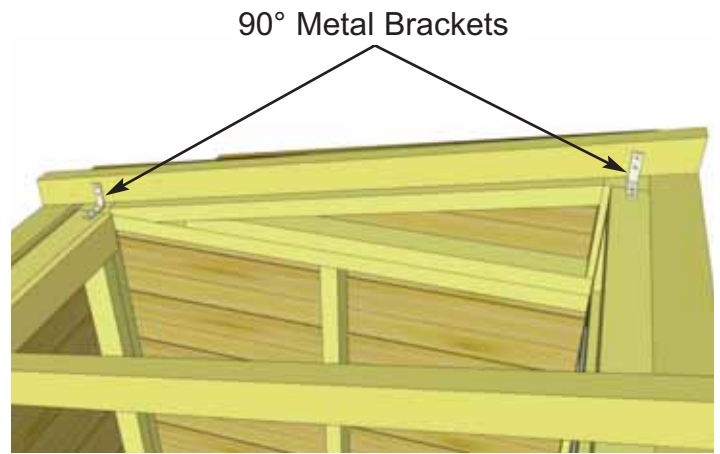
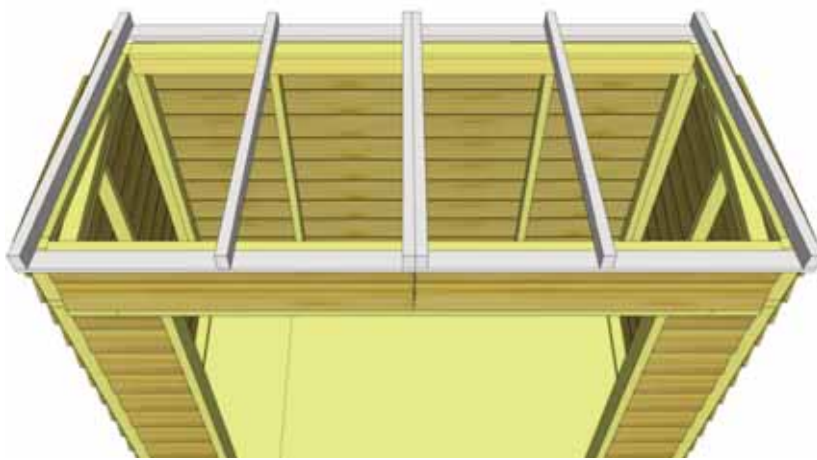

35. With Rafter Section correctly aligned, secure rafters to walls using **90° Metal Brackets**. Start with outside rafters and secure 2 Brackets with 1 1/4" screws. Screw into Wall Extension Framing at the front, and Wall Panel top framing at the rear. Complete both sides.

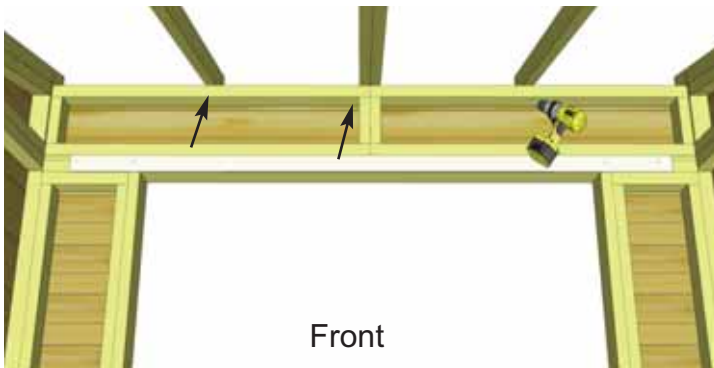

Front



36. With outside rafters properly secured, completely secure remaining interior rafters using 6 - 3" Screws. Screw into rafters from inside of Extension Wall framing at front of shed and inside Rear Wall framing at rear of shed, behind Horizontal Wall Cleats.

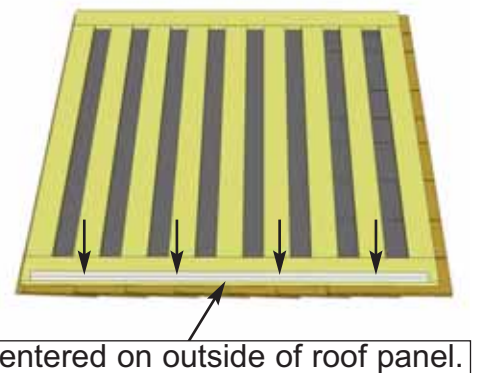
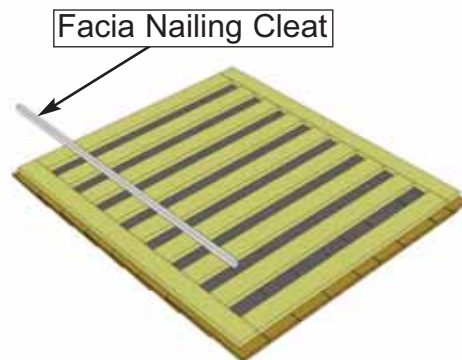
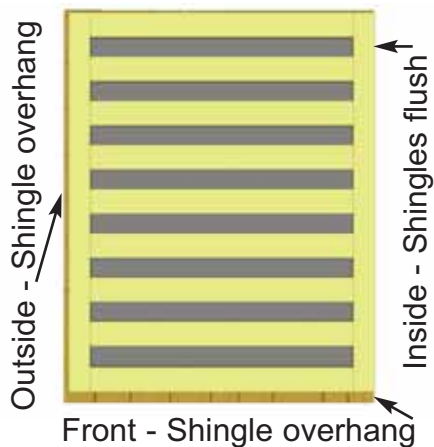

37. Carefully flip Roof Panels over so sheathing is facing up. **Center Rafter/Facia Nailing Plates** (3/4" x 3/4" x 51") onto outside of each panel flush with sheathing. Attach with 4 - 1 1/4" screws evenly spaced. The Rafter/Facia Nailing Plate provides for a greater nailing surface later when you attach side facia.

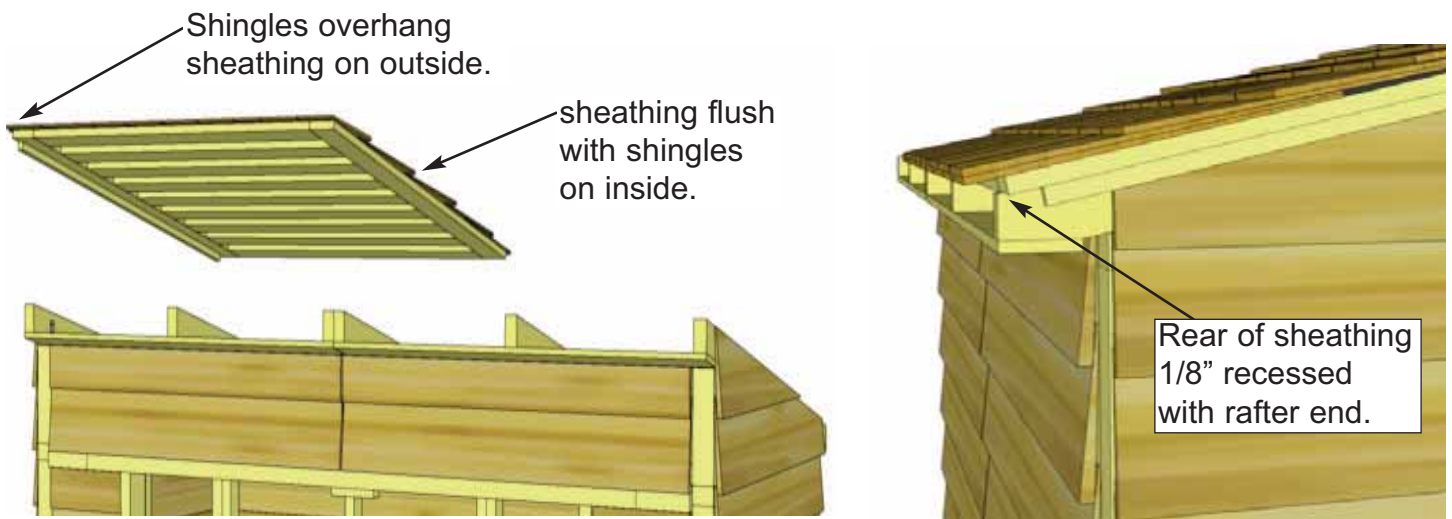

38. Correctly orientate Left Side Roof Panel, with shingles overhanging sheathing on the side of the shed and flush with sheathing to the middle. Place on rafters with rear of sheathing just about flush with rafter ends but just slightly recessed. Doing so allows Rear Facia to sit better.

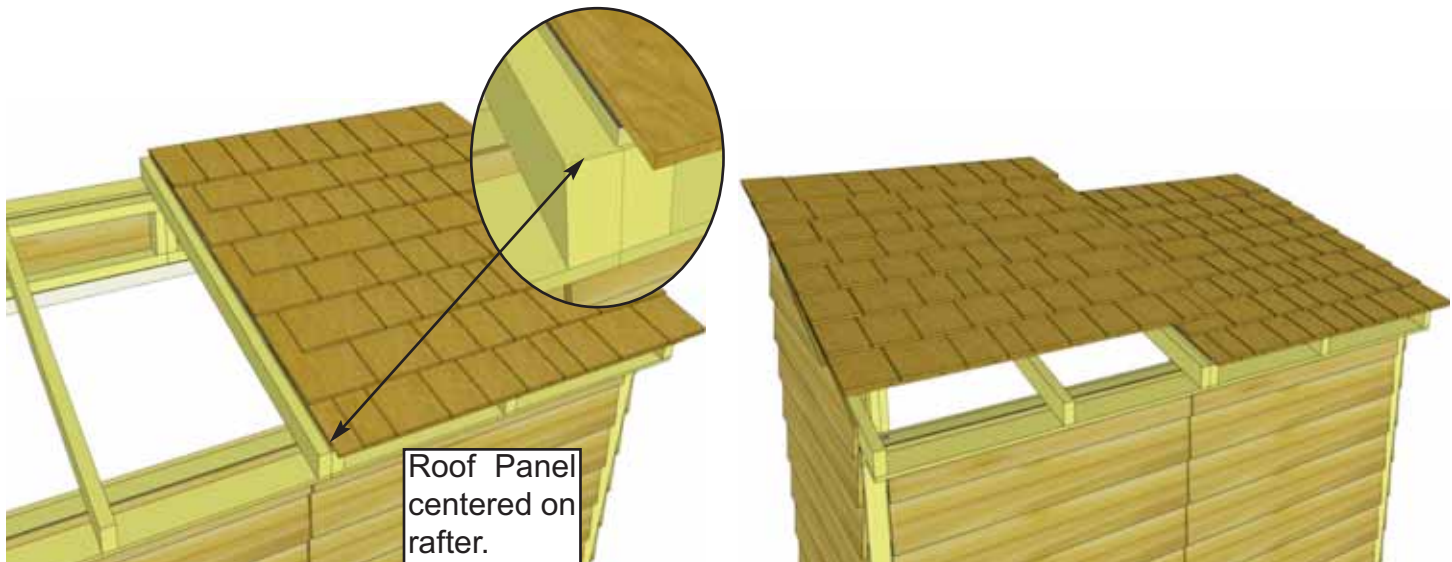

39. For correct Roof Panel position, align panel so sheathing sits evenly on Center Rafters. Complete both roof Panels.



40. With Roof Panels aligned, screw panels down to center rafters with 2 - 2 1/2" screws in **Bottom Row of Shingles Only (1 screw per panel).**

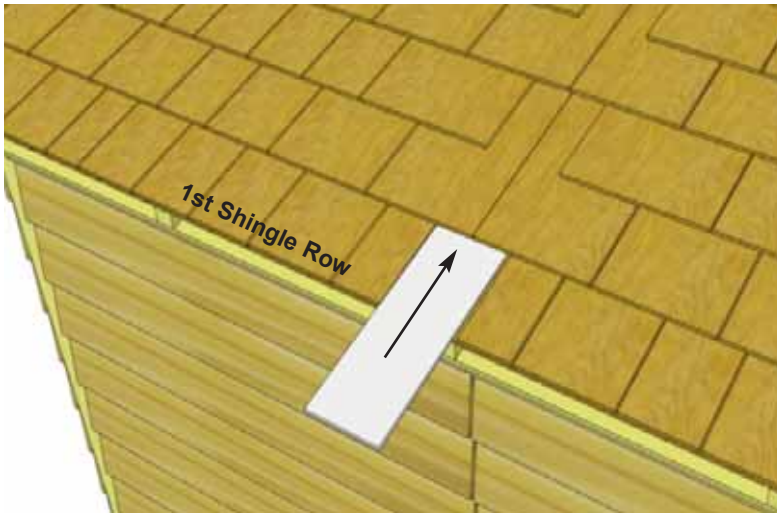

41. To cover roof seam, slide one **Filler Shingle** (5 1/2" wide) up and underneath second shingle row. Push or bang filler carefully with a hammer until evenly spaced and butt is even with other 1st row of shingles.

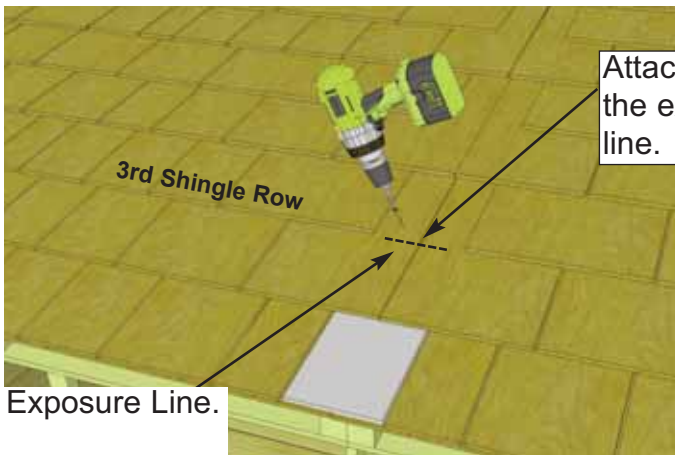
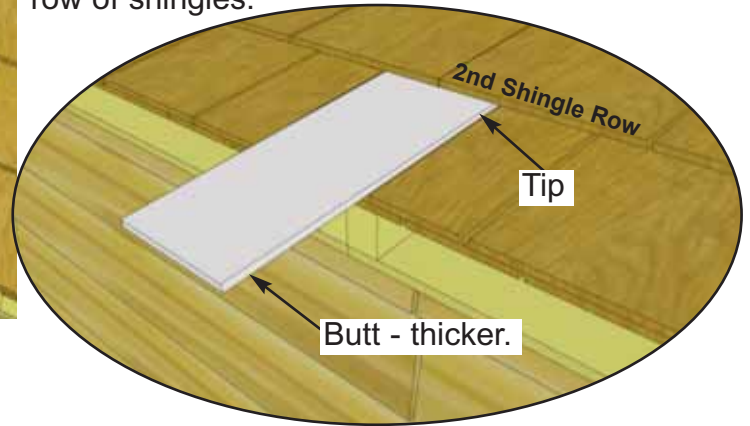

42. Screw first filler shingle down to rafters using 1 - 2 1/2" screw per panel (2 in total). Screw on slight angle and make sure to screw into rafter. Screw slightly above 3rd row of shingles (exposure line). This way, the screw will get covered up when you install your 2nd Filler Shingle and will prevent leaking.

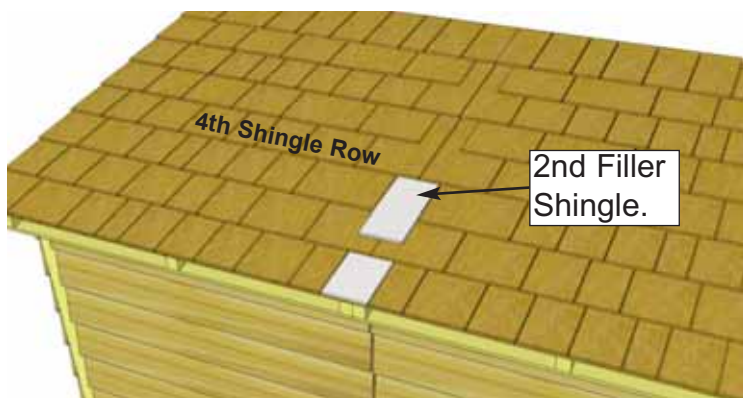
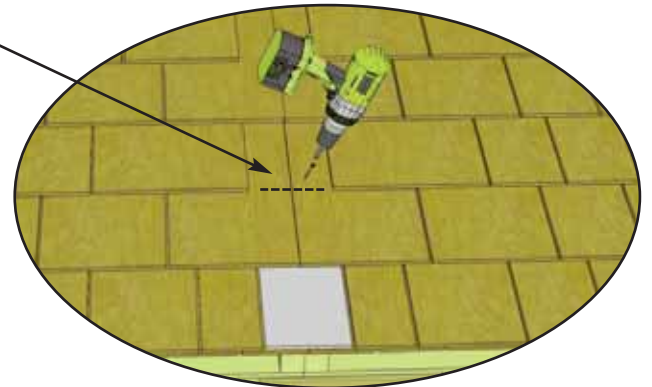

43. Slide 2nd **Filler Shingle** up and underneath fourth shingle row. Follow **Steps 41 - 42** to align and attach.

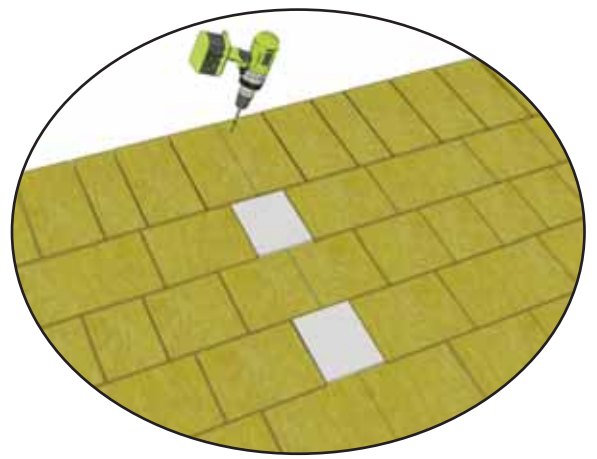
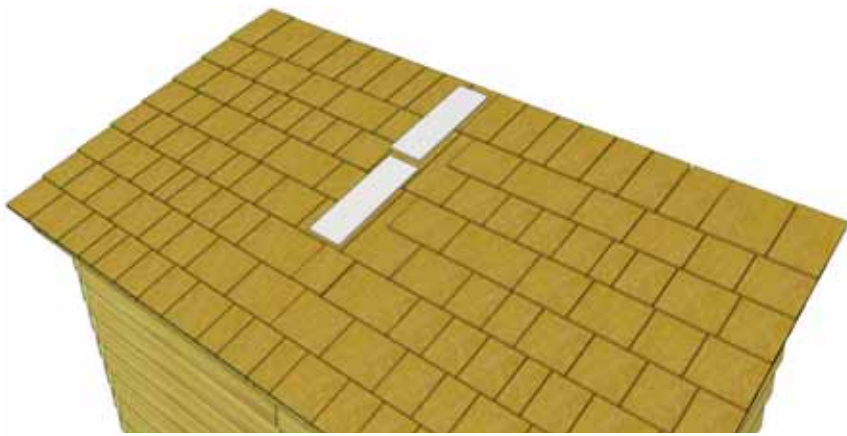

44. Slide 3rd and 4th **Filler Shingles** up and underneath appropriate shingle rows and follow **Steps 41 - 42** to align and attach. On last filler, screws will get covered by Roof Ridge Board (4 1/2" wide).

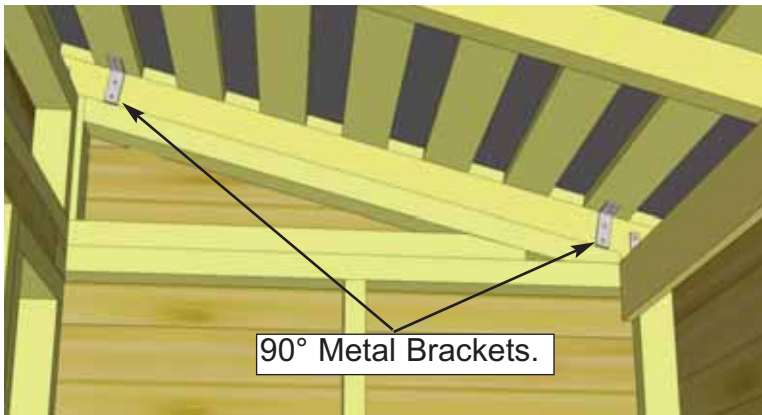

90° Metal Brackets.



45. Secure roof panels to walls at both ends by positioning **2 - 90° Metal Brackets** on sheathing and outside rafters. Secure with 4 - 1 1/4" screws per Bracket, complete both sides.

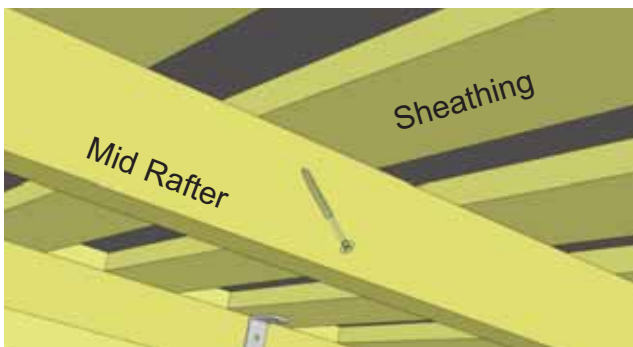

Mid Rafter
Sheathing

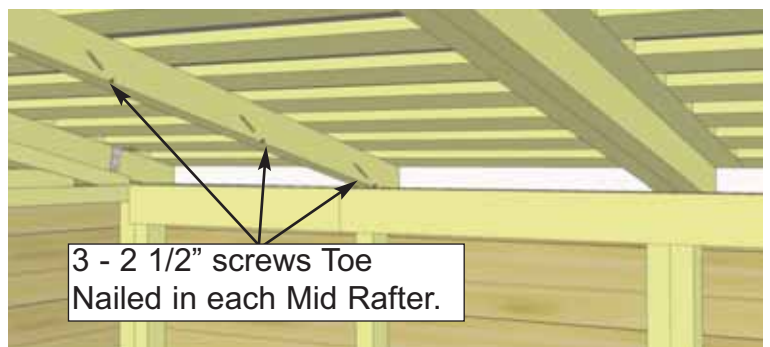

3 - 2 1/2" screws Toe Nailed in each Mid Rafter.

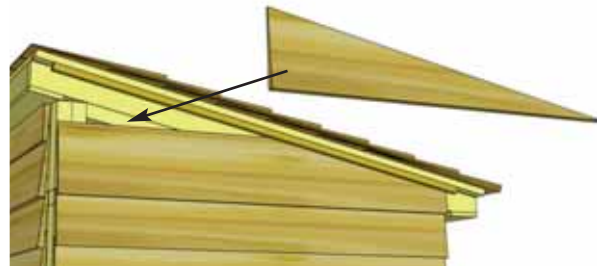
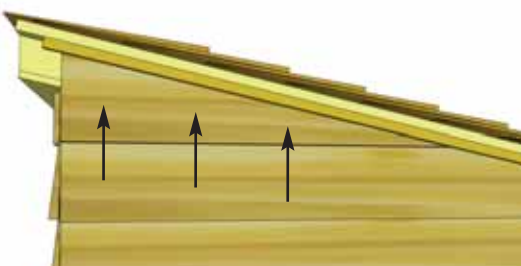

46. To further secure roof panels from the inside, drill pilot holes on an angle in each panel's Mid Rafter (3 per Rafter). Using 3 - 2 1/2" screws, secure rafters to roof sheathing.

Note: from outside if possible, have a helper push roof panel down so sheathing sits flush against rafter while securing. Locate **Top Siding Piece for Angled Wall Extender (L/R)**. Position top siding on wall extender and align as shown above. Attach with 3 - 1 1/2" finishing nails to top wall framing. There are left/right top siding pieces. Use rough surface side out.

D. Miscellaneous Section

Exploded view of all parts necessary to complete the Skirting, Trim, Facia and Miscellaneous Pieces. Identify all parts prior to starting.

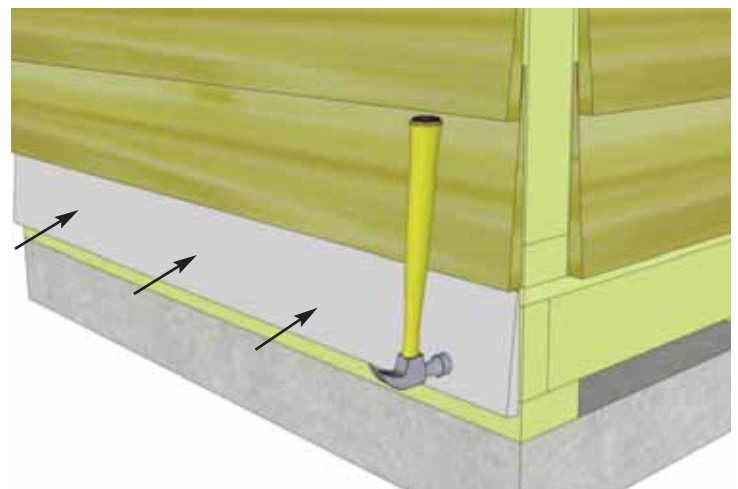
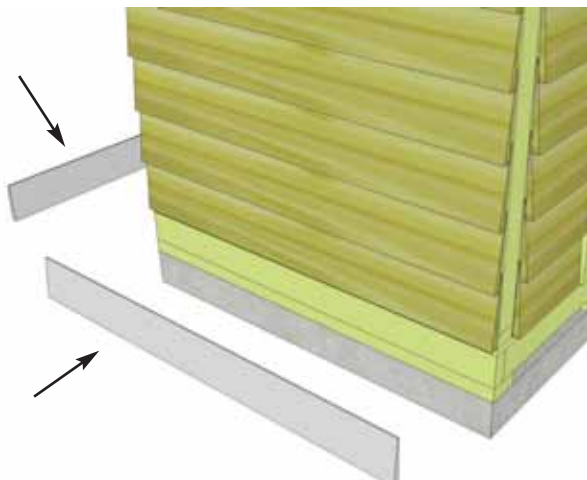
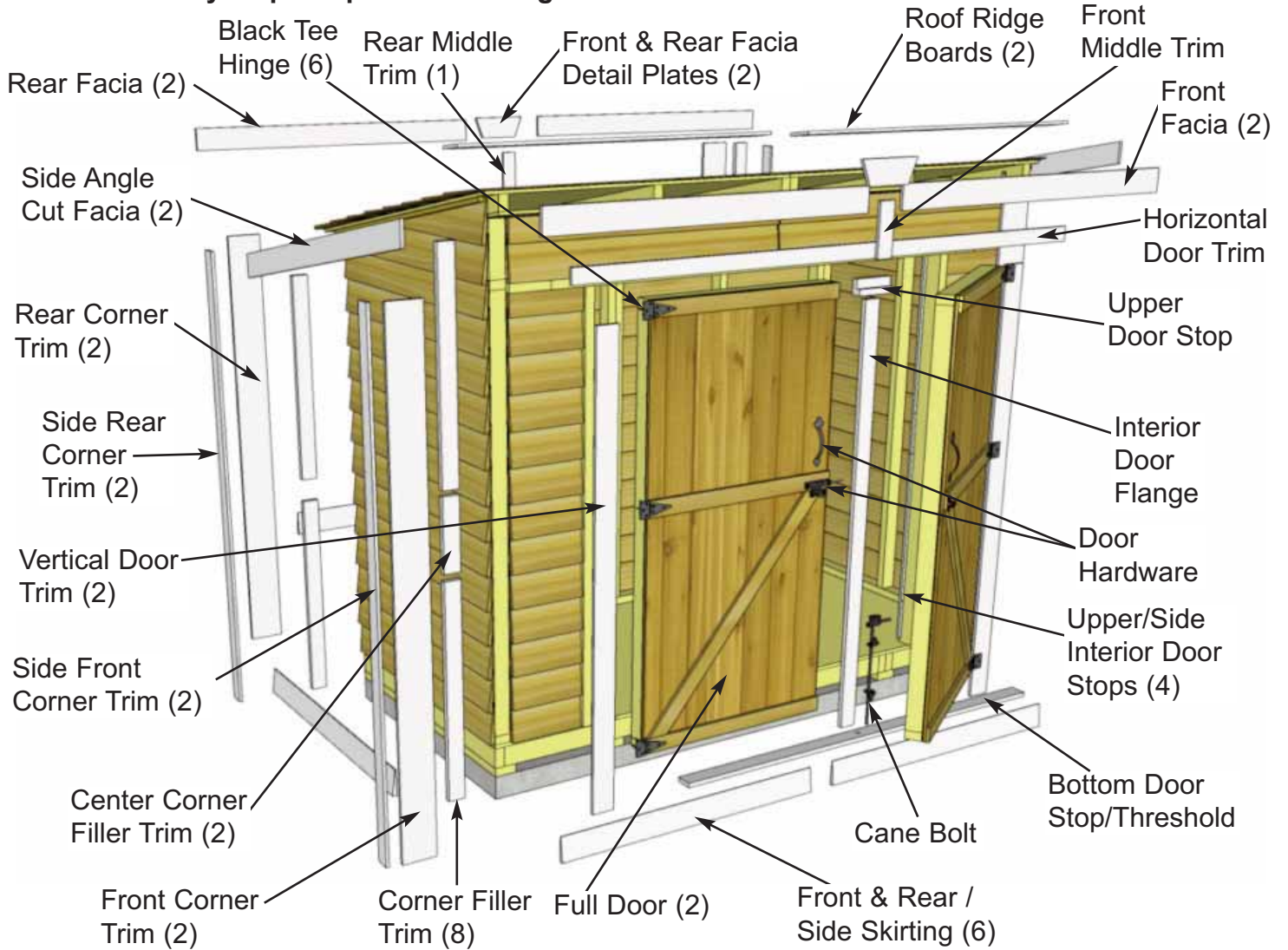

47. Attach **Bottom Skirting** (3/4" x 4 1/2" x 45 1/4" - bevel) around the base of the shed. Skirting will hide floor framing. Start with side skirting pieces first and attach with 4 - 1 1/2" finishing nails per piece.

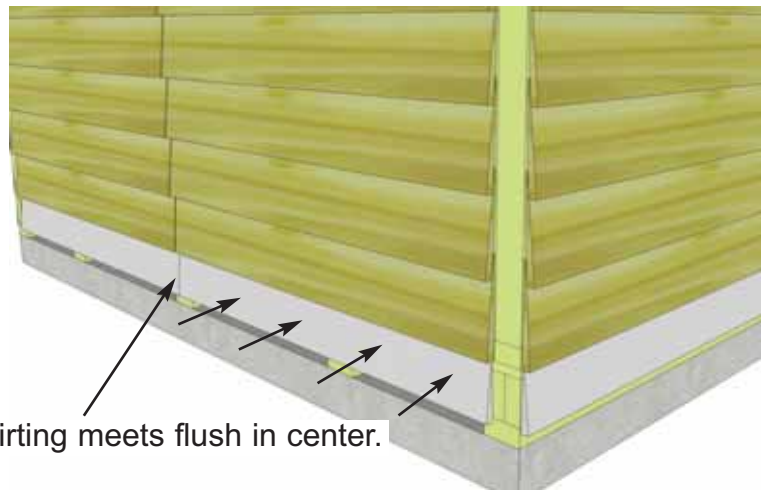

Skirting meets flush in center.

48. Rear skirting pieces will meet together in the center. Secure with 4 - 1 1/2" finishing nails per piece.

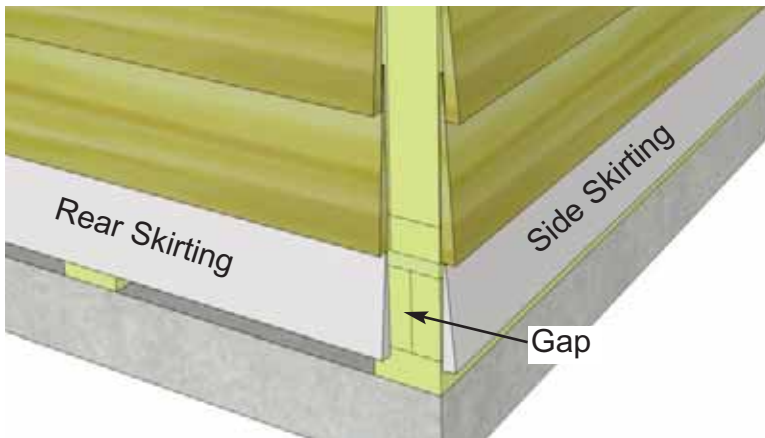

49. Gaps on outside will be covered by Corner Trim pieces later. Complete front and side skirting attachments.

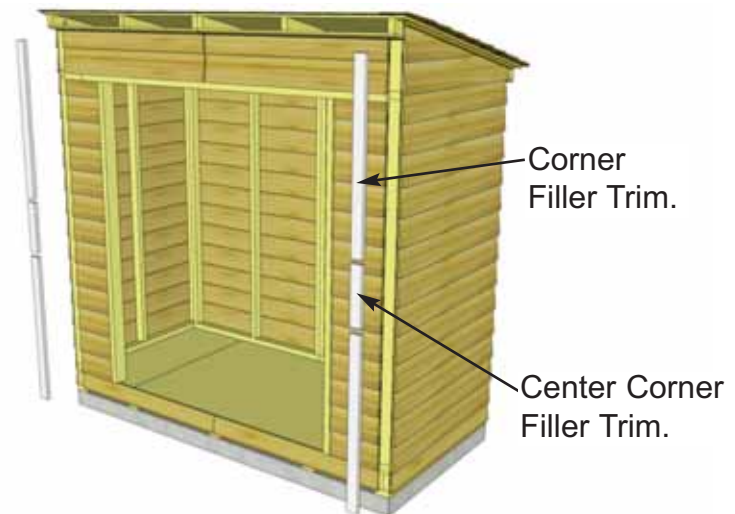
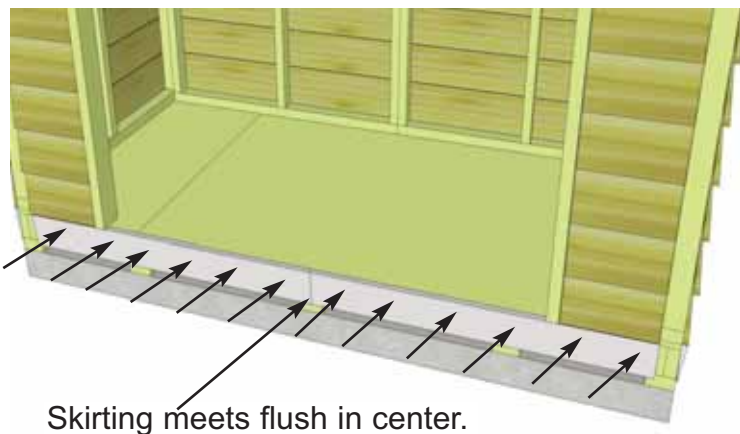

Skirting meets flush in center.

50. Use 6 nails on front skirting piece where doors will be installed. This adds extra support to a high traffic area.

51. Locate **Corner Filler Trims** (8 - 7/8" x 2 1/2" x 36") and **Front Center Corner Filler Trims** (2 - 7/8" x 2 1/2" x 10"). Fillers are essentially nailing strips and will not be visible once additional corner trims are attached later.



52. Attach **Corner Filler Trims** where gaps exist in rear corners (2 per side). Hammer with 8 - 1 1/2" finishing nails. Position bottom filler just below wall siding. Top filler just below soffit. Gap in middle.

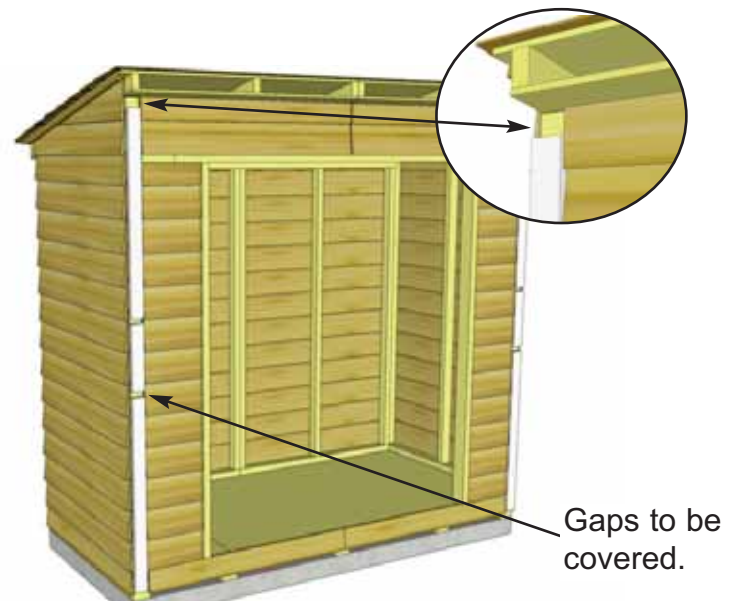
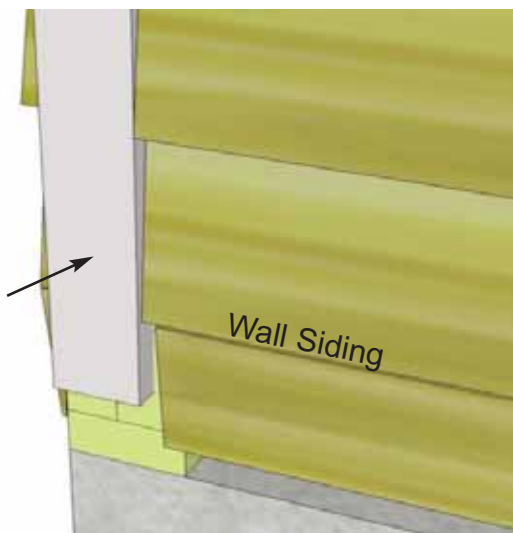

53. Position and attach Corner Filler Trims in the front as per **Step 52**. There is an additional 10" long **Front Center Corner Filler Trim** that you will need to center and attach as well using 2 - 1 1/2" nails.

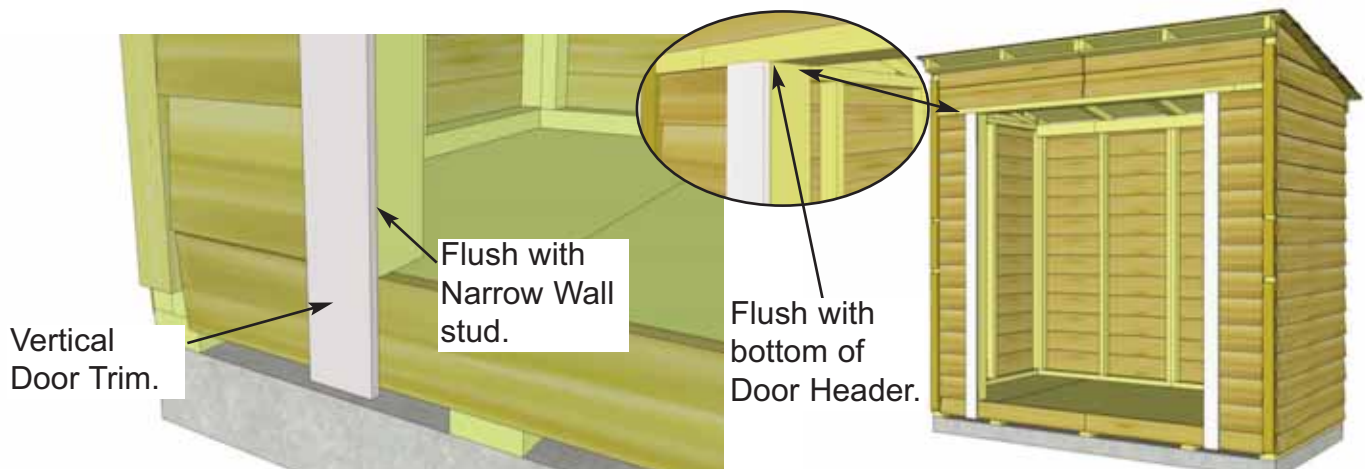

54. Locate **Vertical Door Trim** (2 - 1/2" x 3 1/2" x 77 1/2"). Position Door Trim flush with outside of narrow wall stud. Trim should be aligned just beneath Door Header. Attach with 8 - 1 1/2" finishing nails.

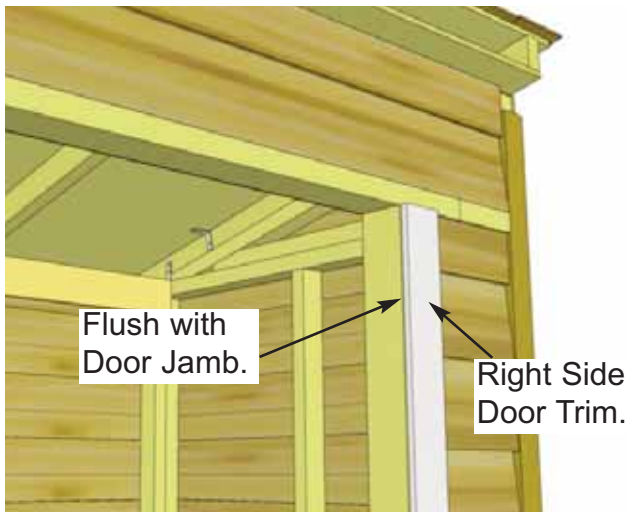

55. Position and attach opposite side Door Trim as per **Step 54**.

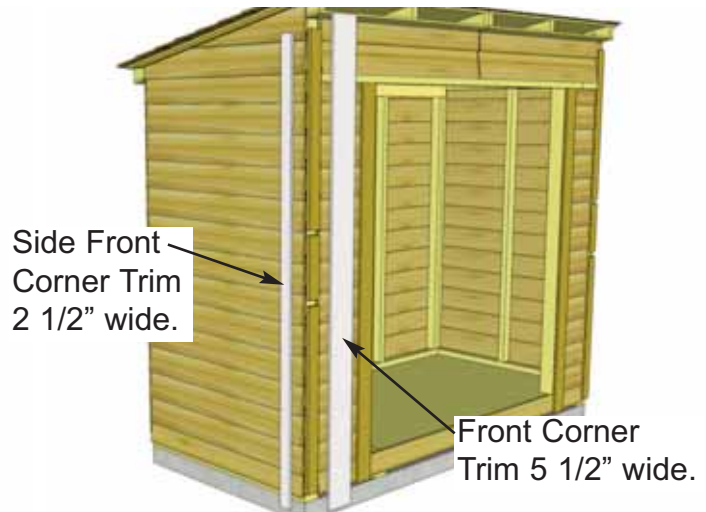

56. To completely trim out front corners, locate a **Side Front Corner Trim** (1/2" x 2 1/2" x 88 3/4") and a **Front Corner Trim** (1/2" x 5 1/2" x 88 3/4").



57. Place both trims in front corner and align as illustrated above. Do a dry run prior to attaching to achieve best fit. Start with 5 1/2" wide Front Corner Trim and align tight underneath soffit to determine vertical height. Attach with 8 - 1 1/2" finishing nails per piece. Position and attach Side Front Corner Trim (2 1/2" wide) using 8 - 1 1/2" finishing nails, aligning at bottom with wide trim.

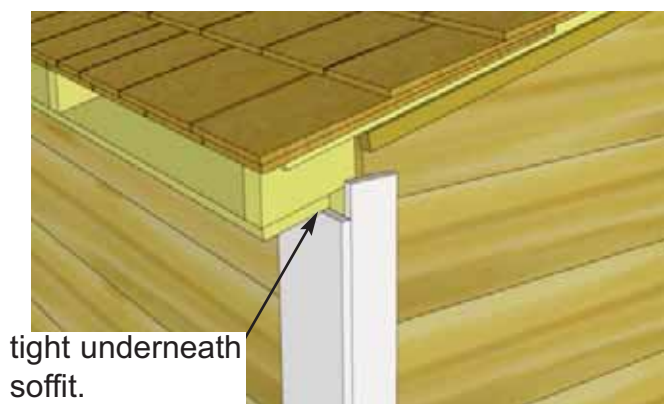
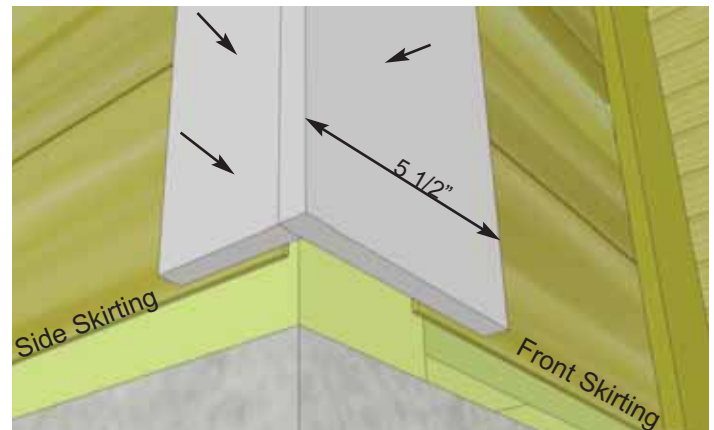

58. To completely trim out rear corners, locate **Side Rear Corner Trims** (1/2" x 2 1/2" x 80") and **Rear Corner Trims** (1/2" x 5 1/2" x 79"). Align and attach as per **Step 57**.

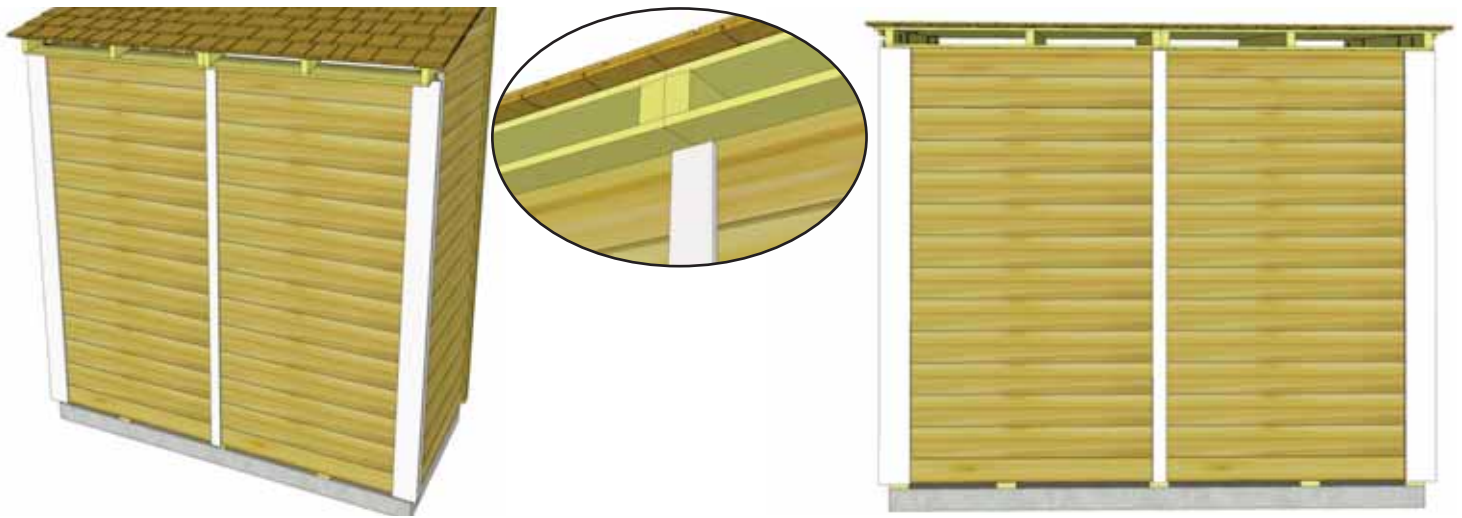

59. Attach **Rear Middle Trim** (1/2" x 2 1/2" x 79") where wall panels come together at rear seam. Attach with 8 - 1 1/2" finishing nails aligning tight underneath soffit and center on seam.

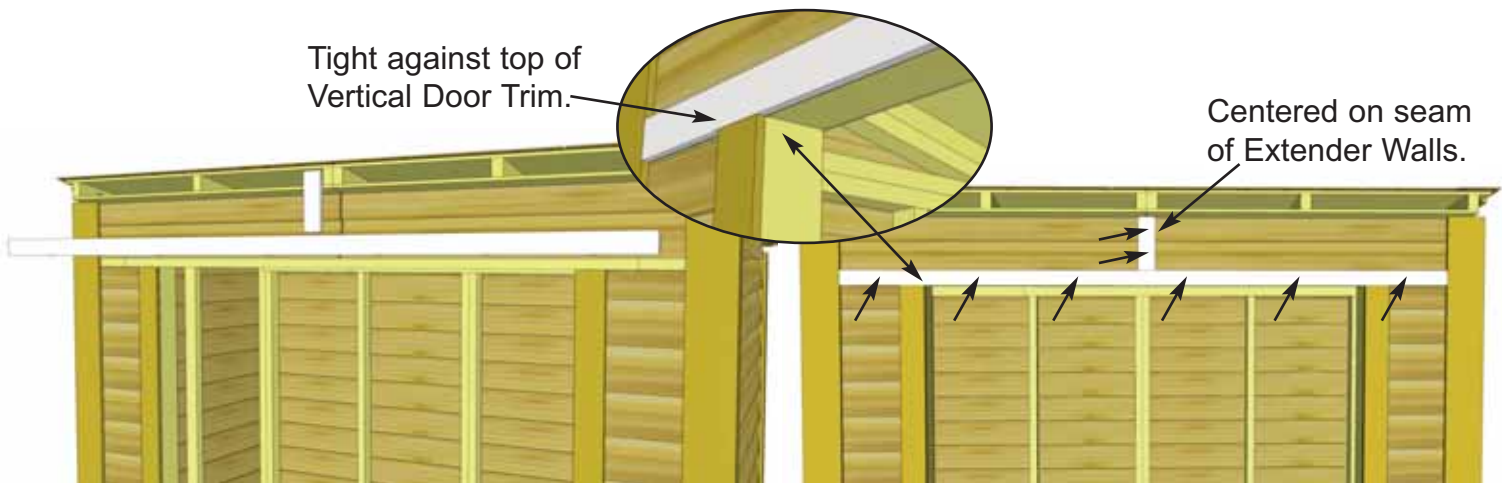

60. Locate **Horizontal Door Trim** (1/2" x 2 1/2" x 88 1/4") and **Front Middle Trim** (1/2" x 2 1/2" x 8 5/8"). Position as shown above and attach with 1 1/2" finishing nails.

Important - Drill Pilot Holes to prevent splitting.

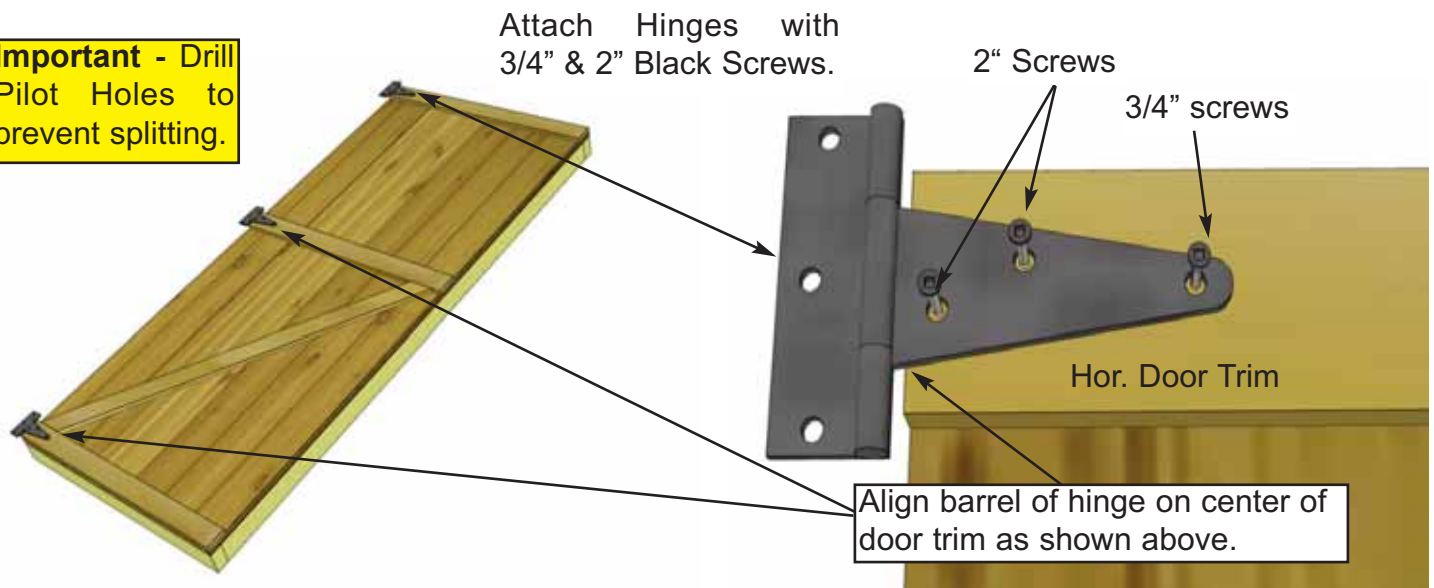

61. Attach Door Hinges to both **Left** and **Right Side Double Doors**. Position Hinges equally on door trim as shown above and attach with Black 3/4" and 2" screws.



Hint: Use Shim Shingle or extra piece of siding to help space Doors at top and bottom.



62. With Hinges attached, position doors in opening. You will need some assistance to hold doors in place.

Important - Drill Pilot holes to prevent splitting.

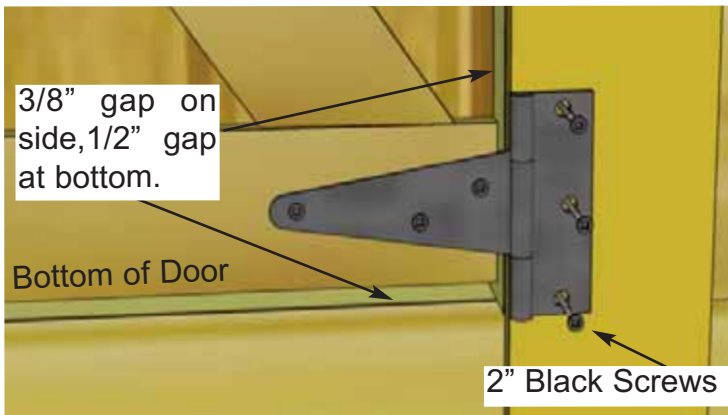

63. Now secure the Double Doors. Starting with **Right Side Door**, position so there is a 1/2" gap on bottom, and approximately 3/8" on the side. Use a spare piece of siding or shingle to shim door in place at the bottom. Using 2" black screws, secure bottom hinge to Door Trim. **Hint:** Do not attach all the 2" screws until both doors are positioned correctly. You can use a Screw Driver to tighten screws completely so you don't over tighten.



64. Make sure Door Panel is aligned evenly at top and edge. When aligned correctly, attach top and middle hinges to narrow trim with 2" black screws.

65. Place second Door into position and attach as per **Step 63**. Make sure Doors can open and shut correctly prior to completely securing all hinge screws.



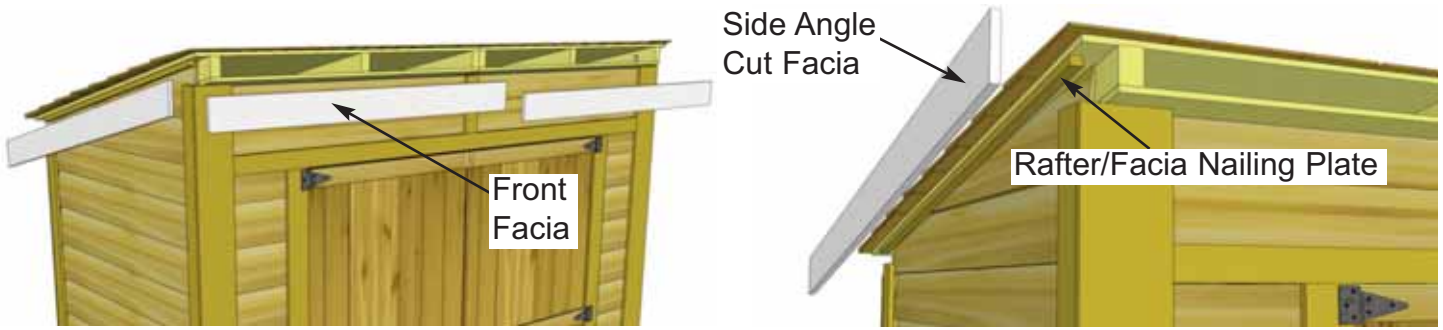

66. Locate and identify all Facia pieces: **Front & Rear Facia (4)** (1/2" x 4" x 50 1/2").
Side Angle Cut Facia (2) (1/2" x 4" x 54 1/8"). In front corner, align side and front Facia together. Front facia will cap side facia.

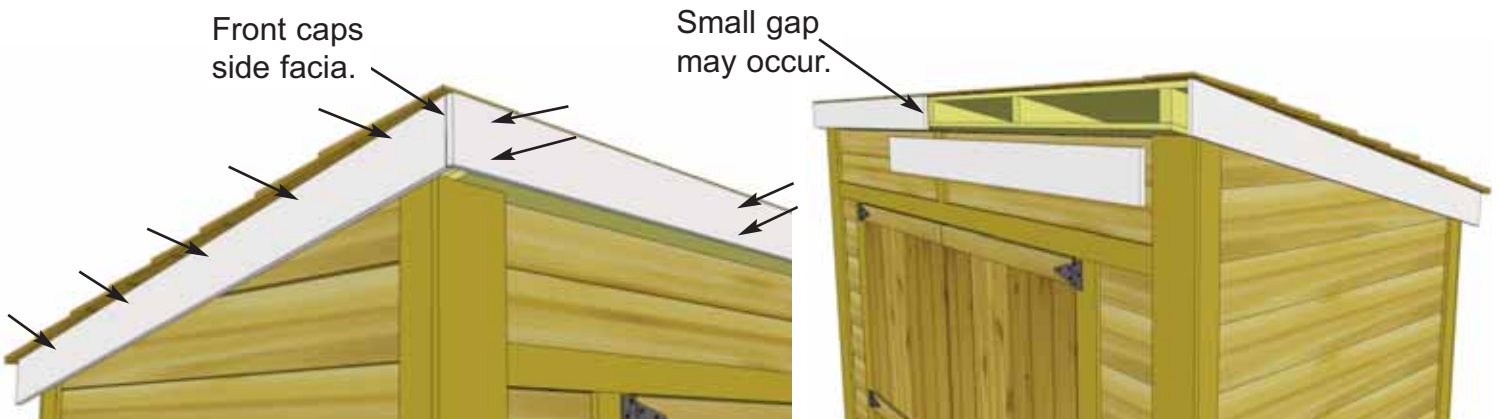

67. Do a dry run first before securing. Position Front Facia up underneath roof panel and against rafter ends. Have your helper hold in position. Place angle cut Side Facia underneath roof panel against Rafter/Facia Nailing Plate. Align so Front Facia caps Side Facia and then attach the front with 6 - 1 1/2" finishing nails. Attach side with 5 - 1 1/2" nails securing them into the nailing plate (closer to the top of the side facia board). Attach next piece of Front Facia. **Note:** With Front Facia correctly aligned at corners, a small gap may occur at center seam. This will be covered by Facia Detail Plate in **Step 70**.



68. Place and align rear and side facia for best possible fit with rear capping side facia. Attach facia to rafter ends with 6 - 1 1/2" finishing nails per piece. Complete both rear facia pieces.

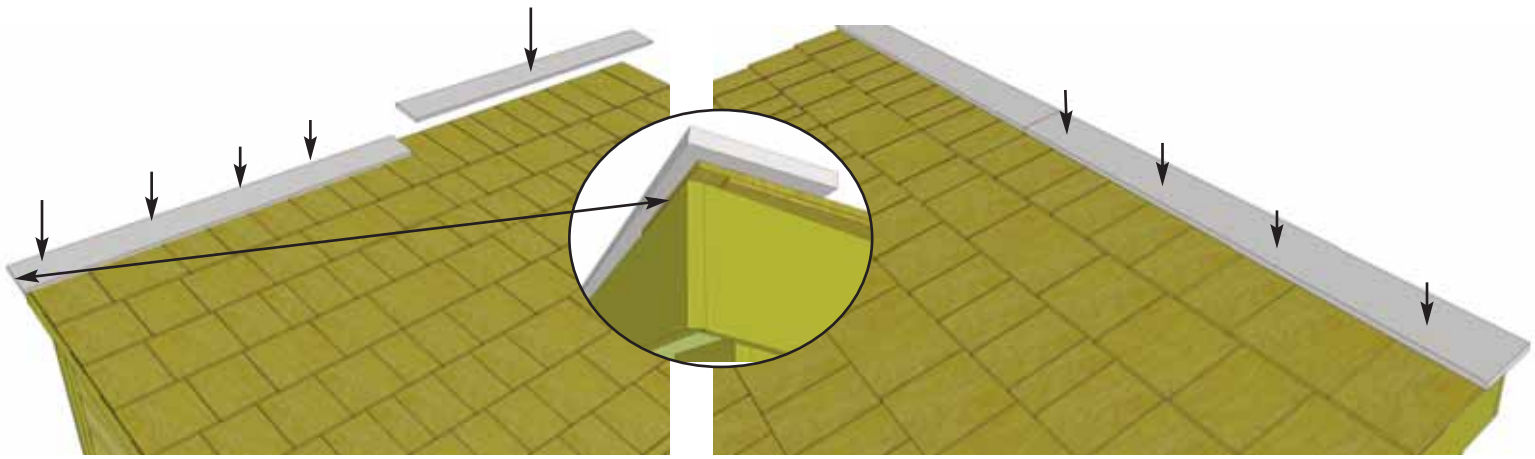

69. Position first **Roof Ridge Board** (1/2" x 4 1/2" x 51 5/8") at the front of roof to cap off shingles and fascia. Ridge Boards should meet on seam of roof panels. When aligned correctly, attach with 4 - 1 1/2" nails per piece.

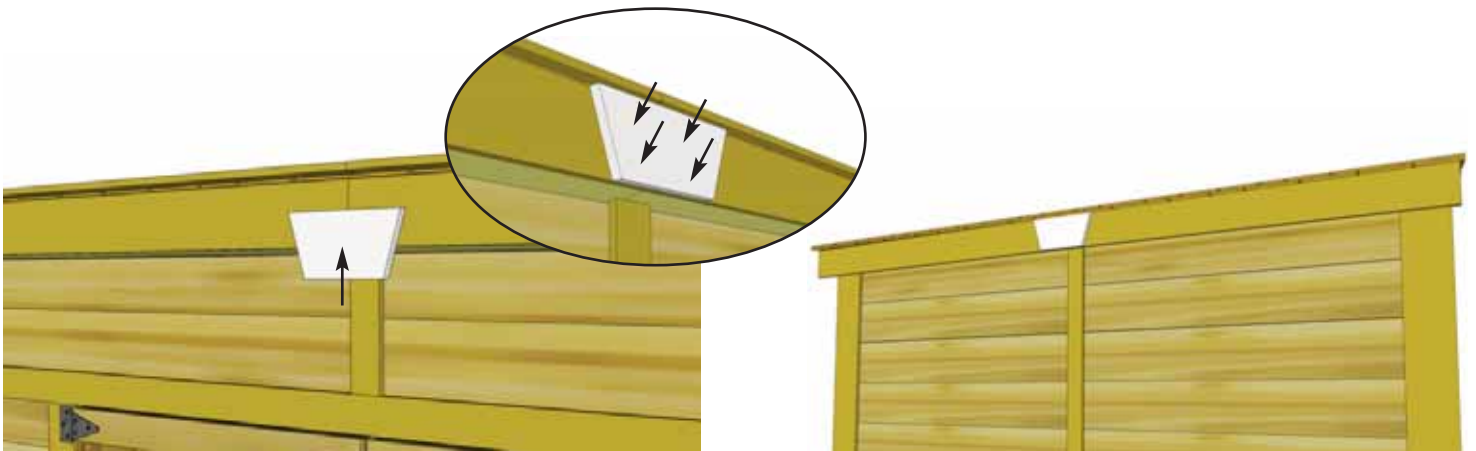

70. Attach **Facia / Detail Plates** to cover seams where Front and Rear Facia pieces come together. Secure with 4 - 1 1/2" finishing nails per piece.



71. Attach **Upper Interior Door Trim (2)** (1/2" x 1/2" x 28 7/8") positioning 1st trim against door jamb and underneath door header flush to edges on inside as shown to the right. Attach with 4 - 1 1/2" finishing nails.

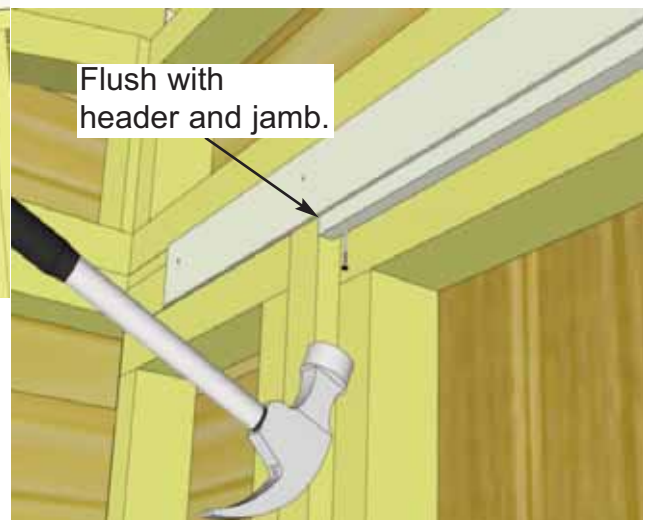



Lower interior door trim.

72. Attach 2nd upper interior door trim as per **Step 71**. Position and attach all **Side Interior Door Trim (4)** (1/2" x 1/2" x 35 7/8") 2 per/side. Position against door jamb and underneath upper door trim. Attach with 4 - 1 1/2" finishing nails. Complete lower interior door trim and both side interior trims on other side.

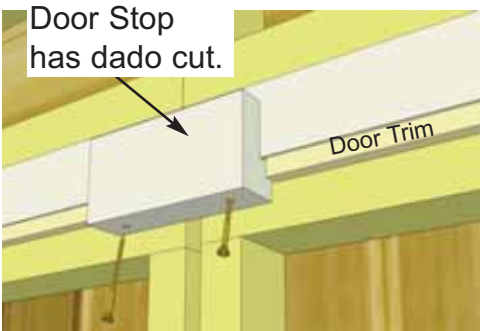

Door Stop has dado cut.

Door Trim

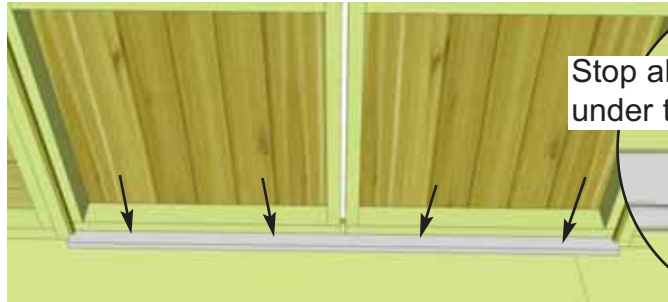

Stop aligned under trim.

73. Attach **Upper Door Stop - dado cut** (1 1/2" x 2 1/2" x 6") underneath door header with 2 - 2 1/2" screws. Stop is pre-drilled on angle. Evenly space between trim.

74. Attach **Lower Door Stop /Floor Threshold** (3/4" x 2 1/2" x 64") - between door jambs. Check door alignment first and then attach with 4 - 1 1/4" screws. **Optional** - caulk the lower edge of threshold to prevent water penetration.

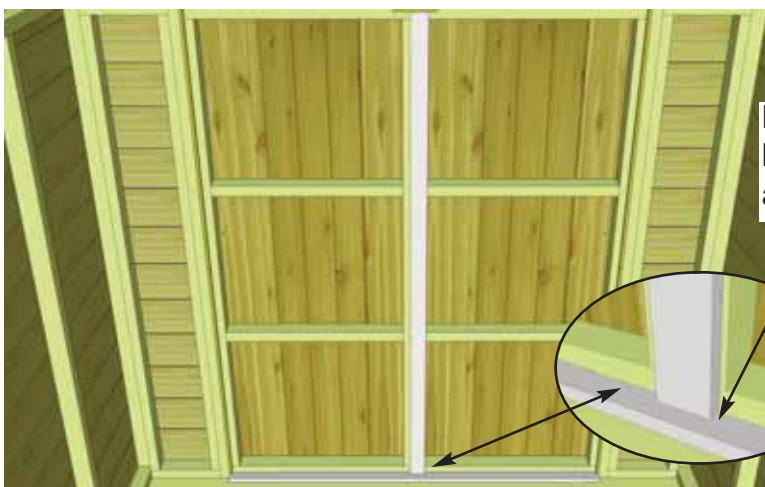
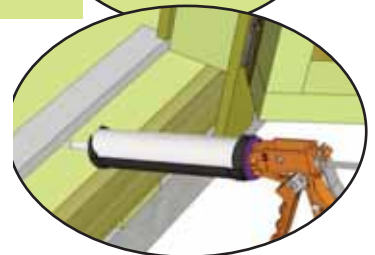

Leave small gap between Stop and Flange.

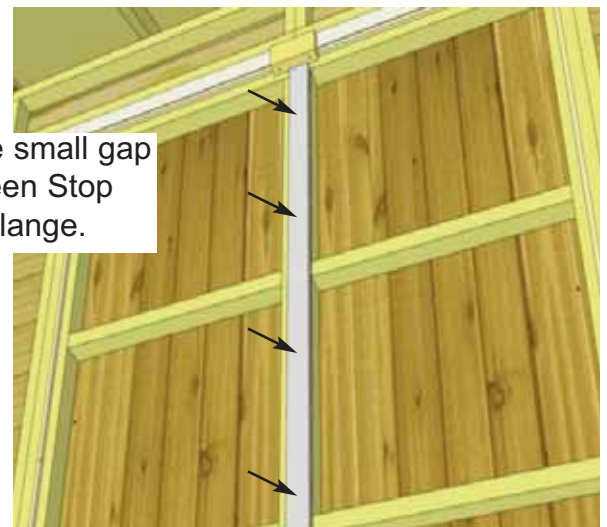

75. Position and attach **Interior Vertical Door Flange** (1/2" x 2 1/2" x 70") on inside door frame (**left door from outside/right from the inside**) using 6 - 1 1/4" screws. Position on inside edge of left door frame so Flange overlaps right door frame by about 3/4".

76. To secure doors, you will need to install the **Interior Cane Bolt** to the Vertical Door Flange. First slide bolt through the upper and lower brackets. Usually the upper bracket is positioned between small nubs in the middle of the bolt. Use 3/4" black screws to secure. Screw on angle and make sure you attach to door frame. Pre-drill to prevent wood from cracking. Attach the holster high enough up so the handle holds the bolt a few inches above the door stop.

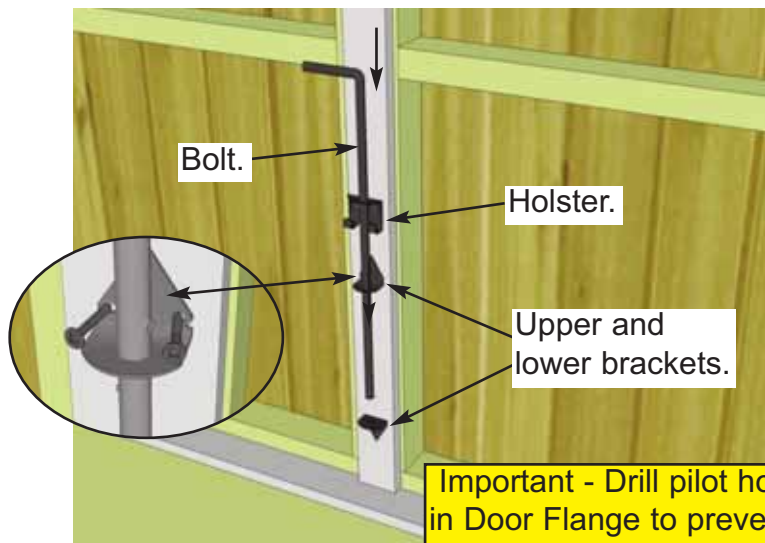

Important - Drill pilot holes in Door Flange to prevent wood from splitting.

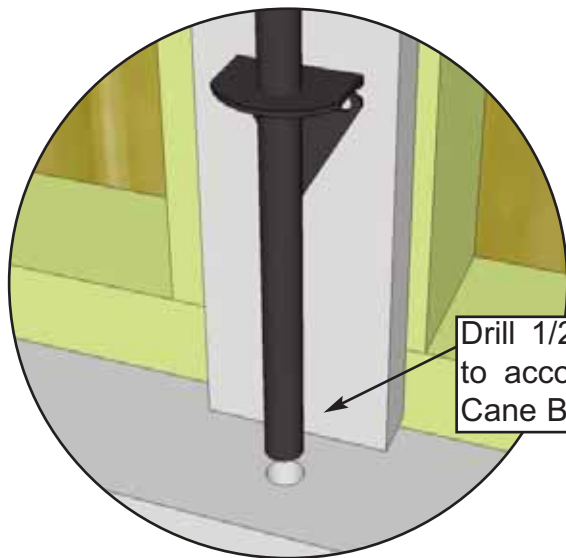

Drill 1/2" Diameter Hole to accommodate rod of Cane Bolt.



77. Once the Cane Bolt is attached, close doors and mark a hole in the stop to accommodate the bolt. You can bang the top of the bolt using a hammer and a block of wood to prevent damage. Once complete, open doors and drill hole where previously marked with 1/2" bit.



78. Attach **Door Handles**. Handles are positioned on top section of each door and mounted with 3/4" Black Screws.

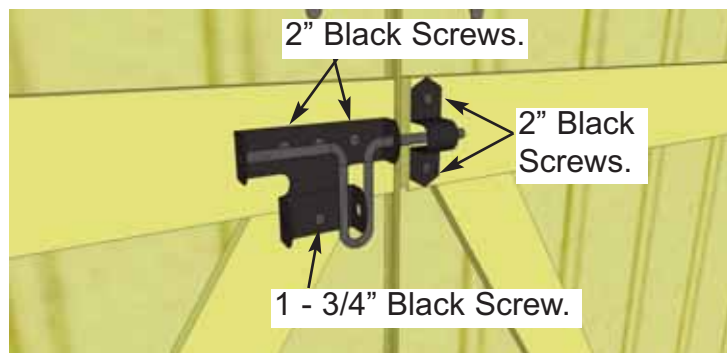

79. Attach Black Drop Latch as illustrated above with 2" & 3/4" Black Screws. Note how female part of Drop Latch is positioned higher than male. Do a dry run first to position Drop Latch correctly. **Important - Drill pilot holes with 1/8" drill bit prior to securing with screws to prevent wood splitting. On 3/4" screw, drill shallow pilot hole only.**

**Thanks for reviewing the
8x4 Garden Saver**
please email us with any and all questions

Made with North American Western Red Cedar

www.CedarShedAndGardenKits.com info@CedarShedAndGardenKits.com

Note: Our Sheds are shipped as unfinished products. If exposed to the elements, the western red cedar lumber will weather to a silvery-gray color. If you prefer to keep the cedar lumber looking closer to the original color, we suggest that you treat the wood with a good oil base wood stain. You may also wish to paint your new shed rather than stain it. In both cases we recommend that you consult with a paint and stain dealer in your area for their recommendations.



We value your feedback and would like to hear back from you on how well we are doing in the following areas:

- 1. Customer Service**
- 2. On Time Shipping**
- 3. Motor Freight Delivery**
- 4. Quality of Materials**

- 6. Overall Satisfaction.**

Please email John and Pat Motley at
info@CedarShedAndGardenKits.com

The materials contained in this Assembly Manual may be downloaded or copied provided that ALL copies retain the copyright and any other proprietary notices contained on the materials. No material may be modified, edited or taken out of context such that its use creates a false or misleading statement or impression as to the positions, statements or actions.