

Cedar

Shed & Garden Kits

8'x4' GardenSaver with rear sloping Cedar Single Roof and a Single Door ASSEMBLY MANUAL

Made with North American Western Red Cedar

www.CedarShedAndGardenKits.com info@CedarShedAndGardenKits.com

**Thanks for your interest in
the 8x4 Garden Saver
Shed ~ John and Pat**

**Delivery is Free from the
Factory to your Home,
Ranch or Business and
Liftgate Delivery is always
included with every order.**

Please review this Assembly Manual and the Spec Sheet thoroughly before ordering. We want you to become familiar with all of the tools required and where and when assistants may be necessary. More than anything we want this to be fun and successful!



Optional door configuration

- Snow load ratings vary by geographical location. If heavy or wet snowfall occurs, it is advisable to sweep snow off roof frequently.
- If the product is elevated, any structural and building code requirements are solely the customer's responsibility, and should be abided by.
- In areas with high or gusty wind conditions, it is advisable to install the structure securely to the ground.
- Have a regular maintenance plan to ensure screws, doors, windows and parts are tightly affixed.

Customer agrees to hold OLT Manufacturing and Cedar Shed And Garden Kits LLC, Authorized Dealer, free of any liability for improper installation, maintenance and repair.

In the event of missing or broken pieces, please call the Customer Support Line within 30 days of the delivery of your kit. You'll find the number in your Assembly Manual that comes with the kit. It is our commitment to you to deliver replacement parts, free of charge, within 10 business days of your notification. Replacement parts will not be provided free of charge after the 30 day grace period.

All structures purchased from OLT are covered for a period of one year for defects in manufacturing and workmanship. Costs incurred for customer installations are not included.

Failure to use supplied parts included in this kit could result in poor product performance and may void your warranty.

What to do before my Shed arrives?



- Become familiar with this assembly manual and determine if you can complete the project yourself or will require a professional contractor.



- One helper is recommended to assist in constructing your shed. It generally takes two people two days to assemble a shed. If you're hiring a contractor, their rate should be in line with that duration of work.



- Clear the construction area and ensure a clear pathway for delivery when the freight company arrives. Remove all debris: roots, grass, rocks, etc.



- Excavate the site. Contact your local utilities company to ensure there are no gas or electric lines buried in the area before digging.

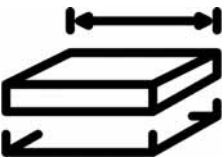

- Decide on the type of foundation you will be using:
 - Concrete slab, or
 - 4-6 inches of crushed gravel with paver stones or 4x4 stringers.

You can find the footprint for your shed on Page 3 of your Assembly Manual.



- If doing the assembly yourself, have all the necessary tools ready to go and in working condition. A list of required tools can be found after the parts list.

Foundation Types for 8x4 Garden Shed

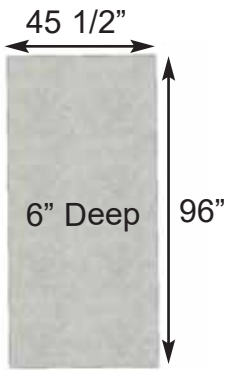

Concrete Foundation

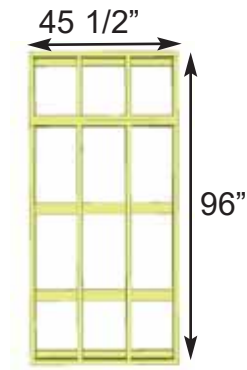

Floor Frame



Completed Foundation

Concrete Slab Foundation:

- Slab must be at least the same size as assembled floor frame (45 1/2" x 96") or larger.
- 6" Deep foundation.
- 0.6 Cubic Yards of concrete required.
- A concrete slab will have the longest durability out of your foundation options.

Once level, a concrete slab is the easiest surface to build on.

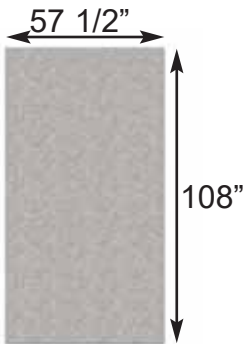

Gravel Foundation

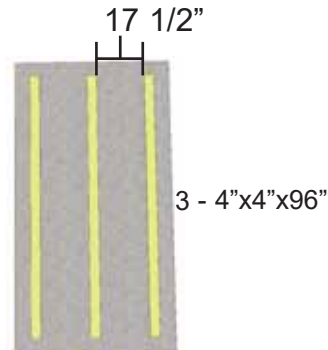

Gravel Foundation with treated stringers



Completed Foundation

Gravel with 4x4 Pressure Treated Stringers:

- Excavate at least 6" deep, and 6" wider than floor frame on each side.
- 1.0 Cubic Yards of gravel required, approximately 9 wheelbarrows.
- 3 - 4x4 Pressure Treated Stringers 8' long required.
- Evenly spaced, with one at each end of floor frame.

Saves money on materials, easy to level and work with.

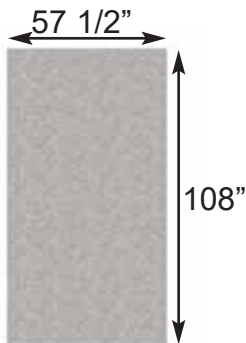

Gravel Foundation

15 Patio Stones



Gravel Foundation with Patio Pavers



Completed Foundation

Gravel with Patio Paver Stones:

- Excavate at least 6" deep, and 6" wider than floor frame on each side.
- 1.0 Cubic Yards of gravel required, approximately 9 wheelbarrows.
- 15 patio pavers (8" x 8" or larger).
- Center patio paver stones underneath floor runners and underneath seams in floor joists.

Patio paver stones are widely available from most landscape stores.

Parts List:

A. Floor Section

- 1 - 45 1/2" x 75" - **Large Floor Frame** (2 Joists unattached)
- 1 - 45 1/2" x 21" - **Small Floor Frame** (2 Joists ATTACHED)
- 2 - 1 1/2" x 3 1/2" x 72" - **Floor Joists**
(Steps 1 - 3)

- 5 - 1 1/2" x 3 1/2" x 45 1/2" - **Floor Runners**
(Steps 4 - 6)

- 1 - 5/8" x 45 1/2" x 75" - **Plywood Flooring**
- 1 - 5/8" x 45 1/2" x 21" - **Plywood Flooring**
(Steps 7 - 8)

B. Wall Section

- 4 - 1 1/2" x 2 1/2" x 45 1/2" - **Wall Plates**
- 4 - 45 1/2" x 75" - **Solid Wall Panels**
- 1 - 45 1/2" x 75" - **Window Wall Panel**
- 1 - 12" x 73" - **Narrow Wall Panels**
(Steps 9 - 18)

- 1 - 2" x 3 1/2" x 45 1/2" - **Door Header - (Dado top edge)**
- 2 - 3/4" x 3 1/2" x 73" - **Door Jambs - Vertical**
(Steps 19 - 21)

- 2 - **Top Triangular Siding Pc for Angle Wall Extenders (L/R)**
- 2 - 45 1/4" - **Angle Wall Extenders (L/R)**
- 2 - 9" x 45 1/2" - **Wall Extenders**
(Steps 22 - 28)

- 1 - 3/4" x 3 1/2" x 70" - **Horizontal Wall Cleat**
- 1 - 3/4" x 3 1/2" x 21" - **Horizontal Wall Cleat**
(Step 29)

C. Rafter & Roof Section

- 6 - 1 1/2" x 2 1/2" x 54" - **Rafters**
- 2 - 1/2" x 3 1/2" x 48" - **Front Soffits**
- 2 - 1/2" x 3 1/2" x 48" - **Rear Soffits**
(Steps 31 - 36)

- 2 - **Rafter/Facia Nailing Strips** - 3/4" x 3/4" x 51"
(Step 37)

- 2 - **Roof Panels** - 51" w x 56" d (1 - Left 1- Right)
(Steps 38 - 40)

- 4 - 5 1/2" Wide x 16" to 18" long - **Filler Shingles**
(Steps 41 - 44)

D. Miscellaneous Section

(Skirting, Trim, Door, Facia & Misc. Parts)

- 6 - 3/4" x 4 1/2" x 45 1/4" - **Bottom Skirting** (Bevel Siding)
(Steps 47 - 50)

- 8 - 7/8" x 2 1/2" x 36" - **Corner Filler Trims**
- 2 - 7/8" x 2 1/2" x 10" - **Front Center Corner Filler Trims**
(Steps 51 - 53)

- 2 - 1/2" x 5 1/2" x 79" - **Rear Corner Trims**
- 2 - 1/2" x 5 1/2" x 88 3/4" - **Front Corner Trims**
- 2 - 1/2" x 2 1/2" x 80" - **Side Rear Corner Trims**
- 2 - 1/2" x 2 1/2" x 88 3/4" - **Side Front Corner Trims**
- 1 - 1/2" x 2 1/2" x 79" - **Rear Middle Trim**
(Steps 54 - 57)

- 2 - 1/2" x 3 1/2" x 77 1/2" - **Vertical Door Trims**
- 1 - 1/2" x 2 1/2" x 46 3/4" - **Horizontal Door Trim**
- 1 - 1/2" x 3 1/2" x 8 3/4" - **Front Middle Trim**
(Steps 58 - 60)

- 1 - 31 1/2" x 72" - **Full Door**
(Steps 61 - 63)

- 2 - 1/2" x 4" x 54 1/8" - **Side Facia** (Angle Cut Ends) - reverse
- 4 - 1/2" x 4" x 50 1/2" - **Front and Rear Facia**
(Steps 64 - 66)

- 2 - 1/2" x 4 1/2" x 51 5/8" - **Roof Ridge Boards**
(Step 67)

- 2 - **Detail Facia Plates** (4" high)
(Step 68)

- 1 - 1/2" x 1/2" x 32" - **Upper Horizontal Door Stop**
- 4 - 1/2" x 1/2" x 36 1/4" - **Vertical Door Stops**
(Steps 69 - 70)

- 1 **Aluminum Window Insert**
(Steps 71 - 72)

Window Trim Pkg

- 1 - 24 1/16" angle cut / 3 - 23" Straight Cut - **Window Trim Kit**
(Step 73)

- 1 **Flower Box Kit**
(Step 74)

- 1 - 45 1/4" - Extra Piece of Bevel Wall Siding - Use if wall panel siding is damaged or to shim floor or door.

Optional Pieces - When Door configured on end.

- 1 - 1 1/2" x 3 1/2" x 73" - **Optional Door Jamb**
- 1 - 1/2" x 2 1/2" x 42 1/2" - **Optional Horizontal Door Trim**
- 1 - 1/2" x 2 1/2" x 88 3/4" - **Optional Front Middle Trim**
(Optional - Steps 77 - 80)

Note: All Trim, Facia and Bottom Skirting pieces will be positioned rough face out when installed.

8x4 GARDENSAVER-Single Door HARDWARE PACKAGE

Hardware Kit (Provided)

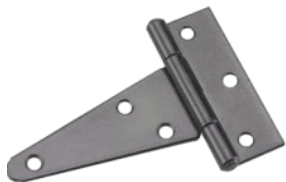
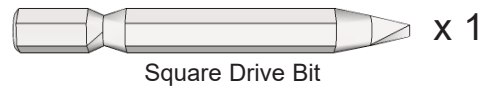
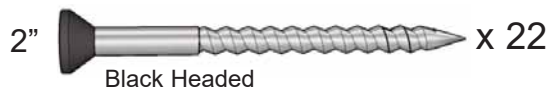

Tee Hinge x 3



Door Handle x 1



Drop Latch



90° Metal Bracket x 8

Tools Required (Not Provided)



Hammer



Screw Gun/Drill x 2



Tape Measure



Wood Clamp



Utility Knife



Level



Pliers



Ladder



Caulking



1/8" Drill Bit

Safety Equipment Required (Not Provided)



Safety Glasses



Work Gloves

Regular Maintenance & Tips to prolong the life of your shed.

Before/During Assembly:

- 1.) Paint each face and edge of your plywood floor with a latex exterior paint.
- 2.) Caulk wall seams if gaps appear.
- 3.) Caulk around window framing.
- 4.) Caulk perimeter between floor plywood and bottom wall plate.
- 5.) Caulk channels in lap siding at the top of your door above the trim, just a drop in each channel.
- 6.) Caulk edge of door threshold (if applicable).
- 7.) Optional: Install a Sill Gasket between floor runners and foundation.
- 8.) Optional: Install an 8" strip of roofing paper below Cedar Ridge Caps for Cedar Roof Sheds.

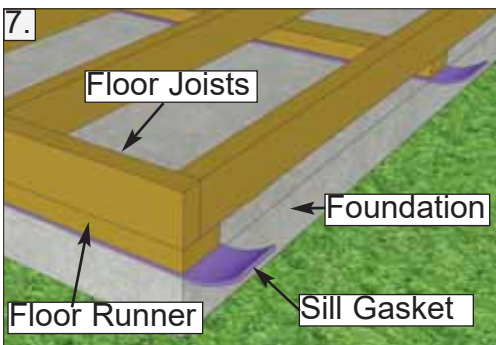
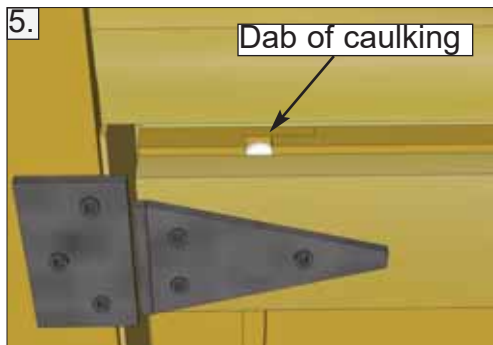
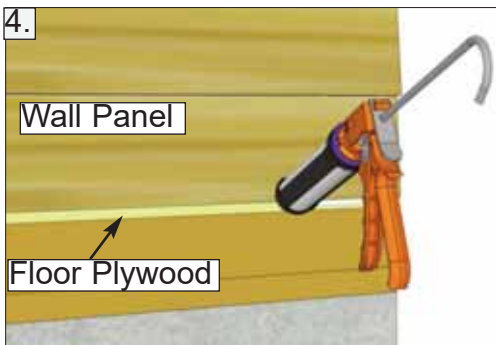
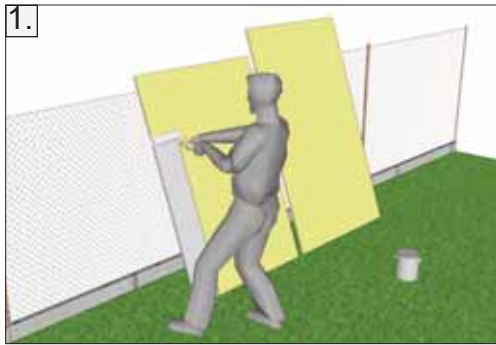

Routine Maintenance:

- Routinely check all fasteners are tight (ex. Door Hinges, Nails)
- Brush off dirt from walls.
- Brush off snow from roof regularly.
- Routinely remove needles and leaves from roof.

Painting/Staining

- Your cedar shed, if left untreated, will weather to a silvery grey colour.
- Painting or staining your structure is highly recommended and will prolong the life of your shed.
- You do not need to wait to paint or stain your shed, the wood in your kit has been dried and can be stained or painted immediately.
- Consult your local paint store for the best paint or stain for cedar.
- Optional: stain the inside of your shed. (Note: this will remove the fresh cedar smell.)

A. Floor Section

Exploded view of all parts necessary to complete Floor Section. Identify all parts prior to starting. Note: Floor Footprint is 96" wide x 45 1/2" deep.

Exploded Floor Section

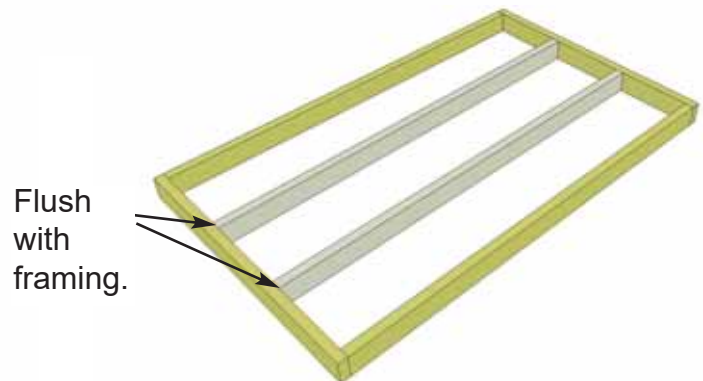
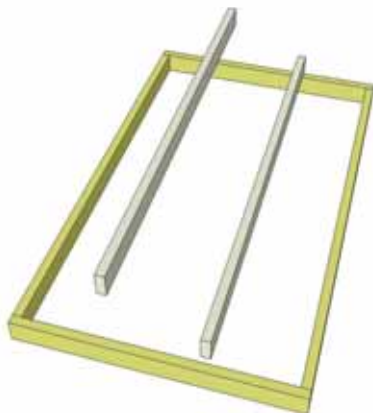
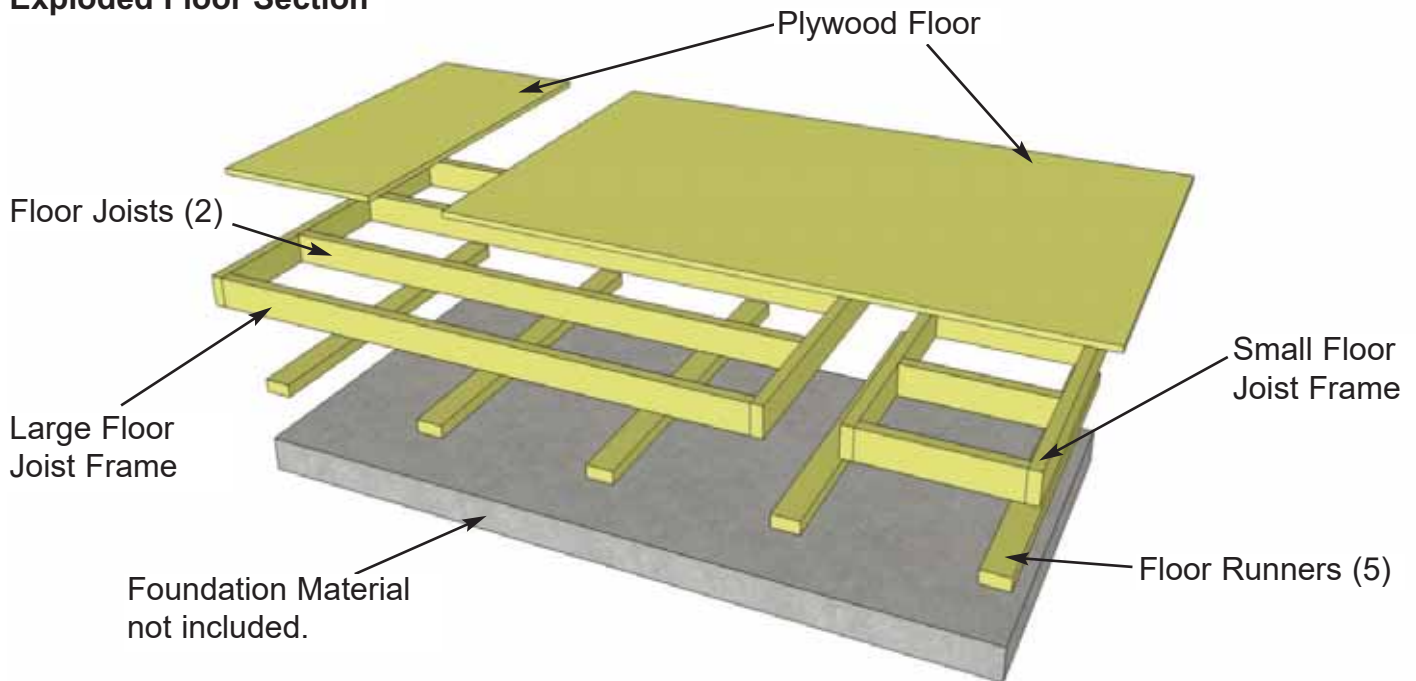

1. Lay out **Large Floor Joist Frame** and **2 Floor Joists** (1 1/2" x 3 1/2" x 71 7/8") as illustrated above. Position Joists equally in Floor Joist Frame. Use **Small Floor Joist Frame** as a template to determine joist position. Position Joist so flush with framing.

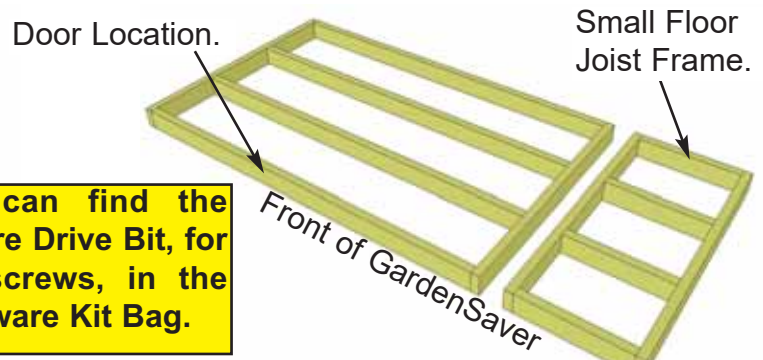
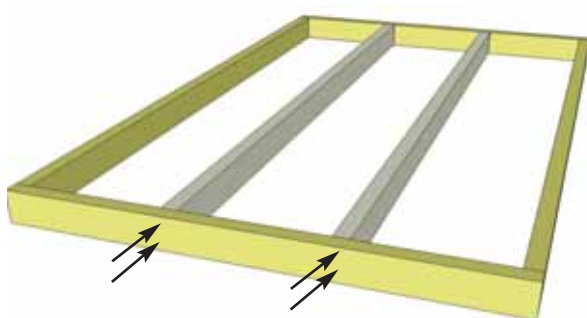

You can find the Square Drive Bit, for the screws, in the Hardware Kit Bag.

2. When correctly positioned, attach each Joist with **4 - 2 1/2" Screws** (2 per end). You can find the **Square Drive Bit** for the screws in with the **Hardware Kit Bag**.

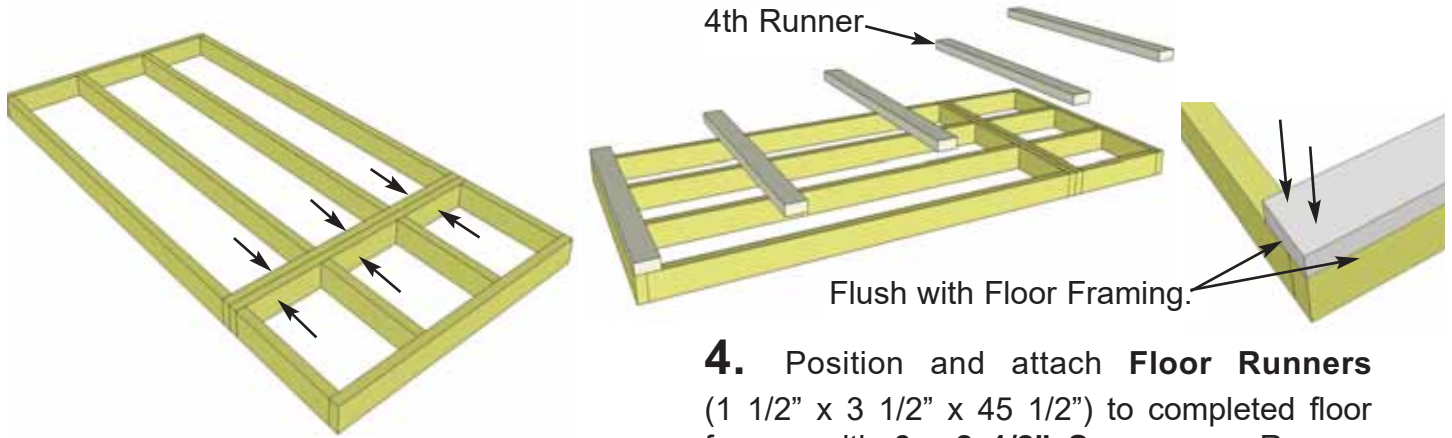

3. With Floor Joist Frames positioned together flush, attach with **6 - 2 1/2" Screws**.

4. Position and attach **Floor Runners** (1 1/2" x 3 1/2" x 45 1/2") to completed floor frames with **6 - 2 1/2" Screws** per Runner. Make sure Runners are flush with outside of floor framing but not overhanging. Make sure 4th Runner is placed equally over seam where floor frames meet.

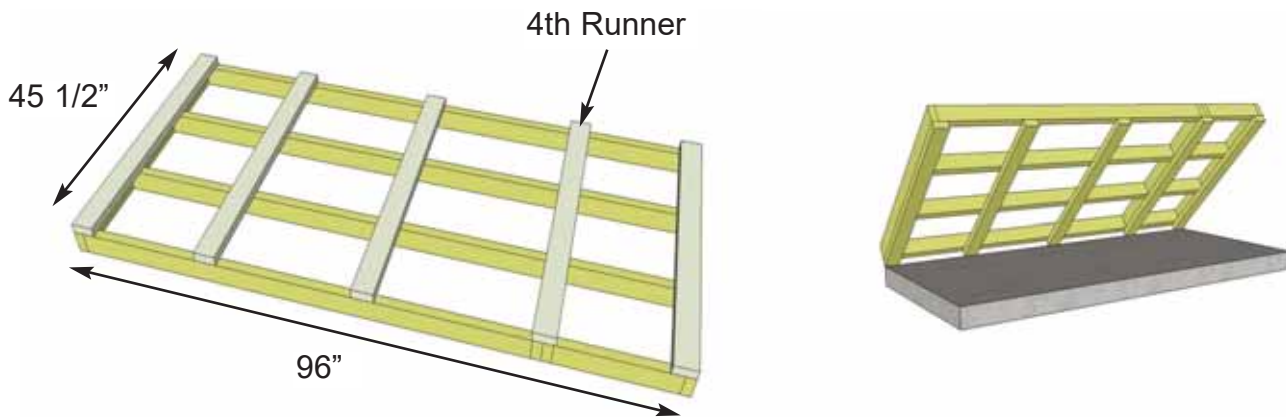

5. With Floor Runners attached, carefully flip the floor over and place on your foundation. **Caution** - you may need 2 people to assist you. Be careful when laying floor down not to bend or twist floor. **Note:** The floor will be flipped over and floor runners will sit on your foundation. It is important to note that having a level foundation is critical. Choosing a foundation will vary between regions. Typical foundations can be concrete pads or patio stones positioned underneath the floor runners.

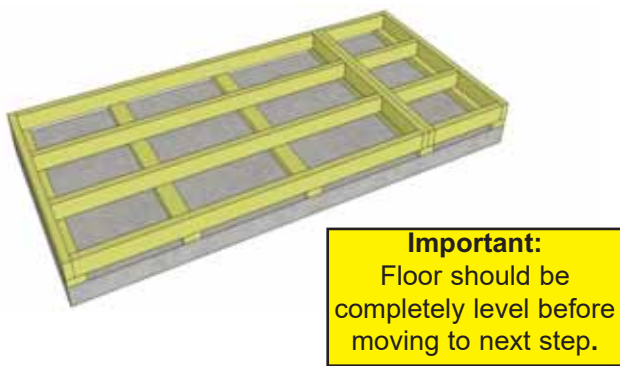

6. When in place, level floor completely before proceeding.

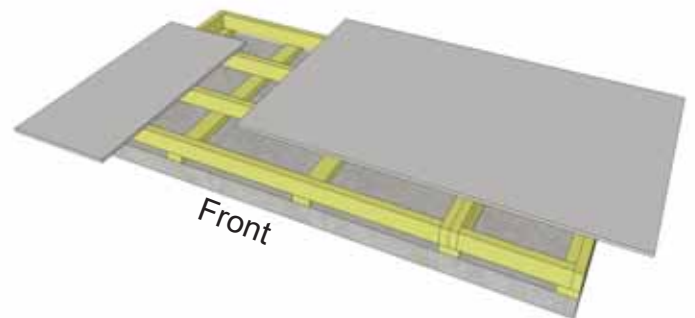

7. Position **Plywood Floor** pieces (2) on top of completed floor joists.

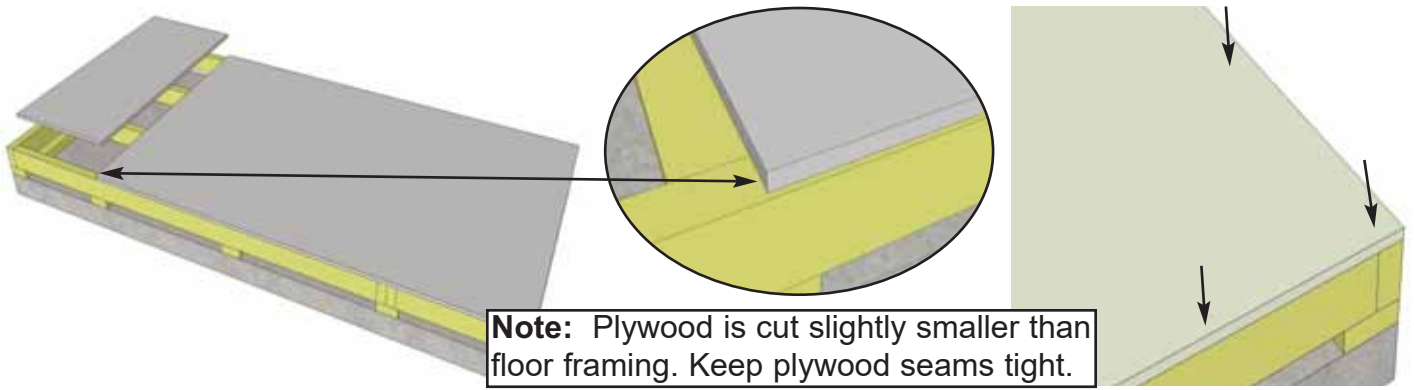

8. Position Plywood so it sits almost flush with outside of floor joist framing (see **Note**). When correctly positioned, attach to all floor joists with approximately **24 - 1 1/4" Screws**. Use screws every 16".

B. Wall Section

Exploded view of all parts necessary to complete the Wall Section. Identify all parts prior to starting.

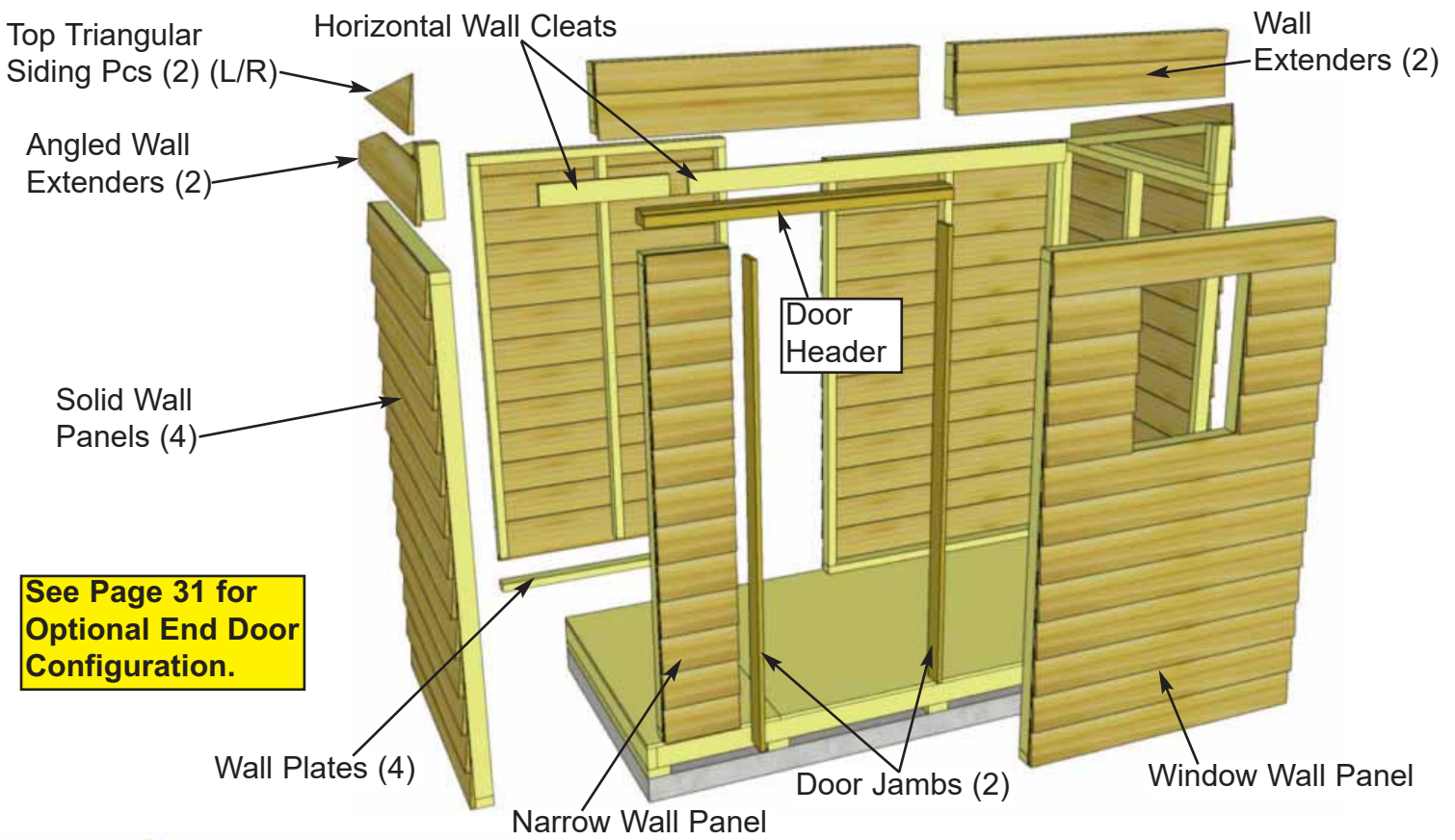

See Page 31 for Optional End Door Configuration.

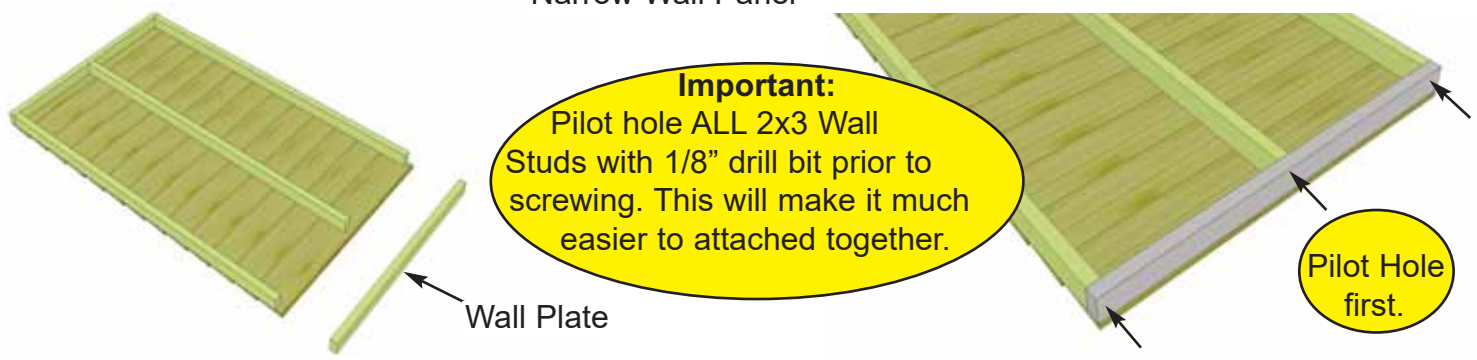

9. Locate 4 **Solid Wall Panels** and 4 **Wall Plates** (1 1/2" x 2 1/2" x 45 1/2"). Attach Plates to bottom of studs of each wall panel with **3 - 2 1/2" Screws**. Position so plates are flush with framing.

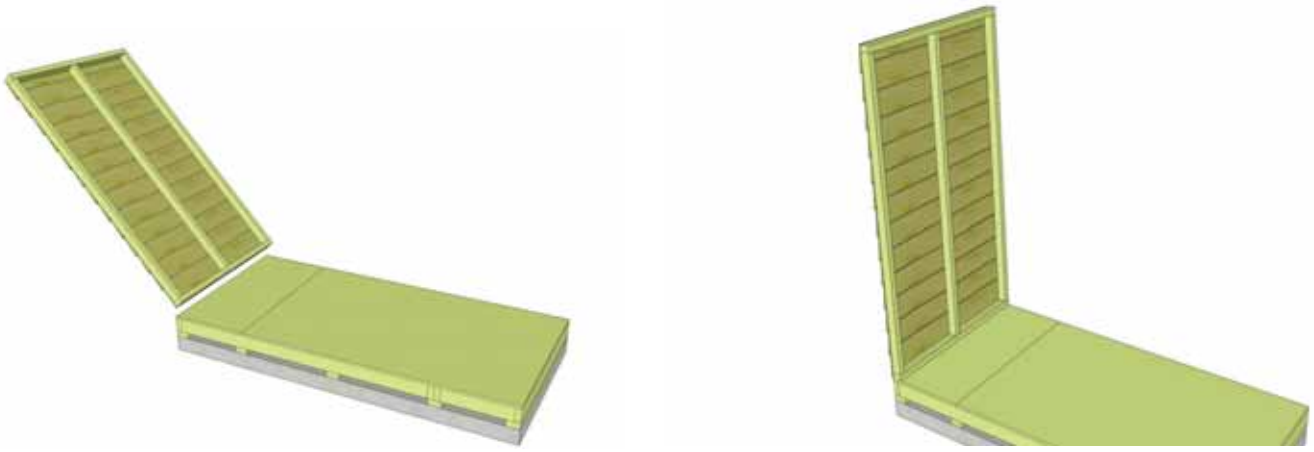

10. Starting on side, position a **Solid Wall Panel** on top of plywood floor. The Wall Panel bottom framing will sit flush with floor framing. Wall siding will overhang the floor. **Important:** Make sure all walls are aligned in their upright position. If not, water may leak into your shed. Unsure if panel is facing up or down? Recently attached Bottom Plate is on bottom of panel.

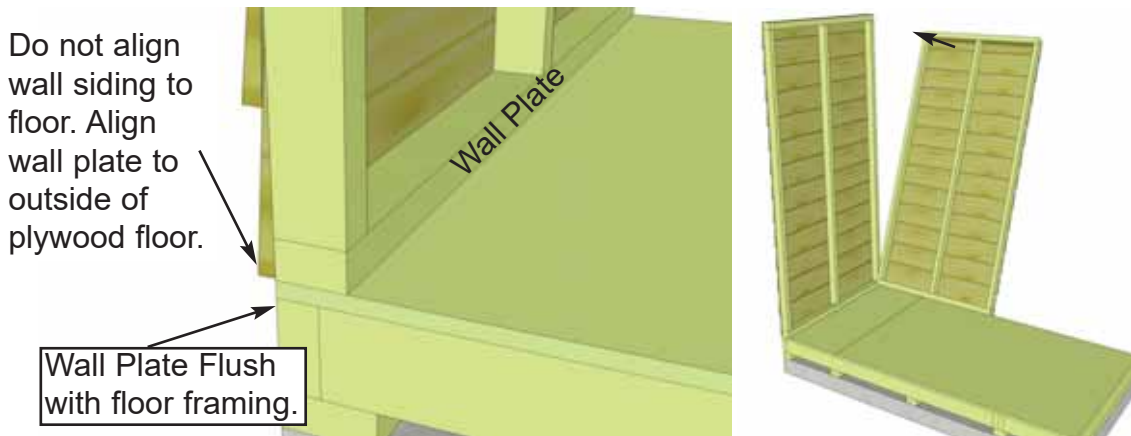

11. Outside 2x3 framing of wall panel should be flush with outside of floor framing when properly aligned. **Note:** Do not align wall siding to floor. Align wall plate to outside of plywood floor. When positioned correctly, locate 2nd Solid Wall Panel and place in corner.



12. Butt both vertical wall studs of side and rear walls together and attach with **3 - 2 1/2" Screws**. Screw at the bottom, middle and top of stud to secure properly. Have helper push wall framing together while securing to ensure tight fit.



13. With the corner wall attachment complete, position the second rear wall panel in place so bottom 2x3 wall framing is sitting flush with outside floor framing. Wall siding should overhang floor by approximately 3/4". When positioned correctly, attach both wall panel studs together as per **Step 12** with **3 - 2 1/2" Screws**.



Do Not Attach Walls To Floor until Step 30.



14. With Rear Wall Panel in place, position other side wall panel on floor as per **Step 10 & 11**.



15. Secure side wall panel to rear wall panel as per **Step 12**. Next, locate the **Narrow Wall Panel** and position in front.

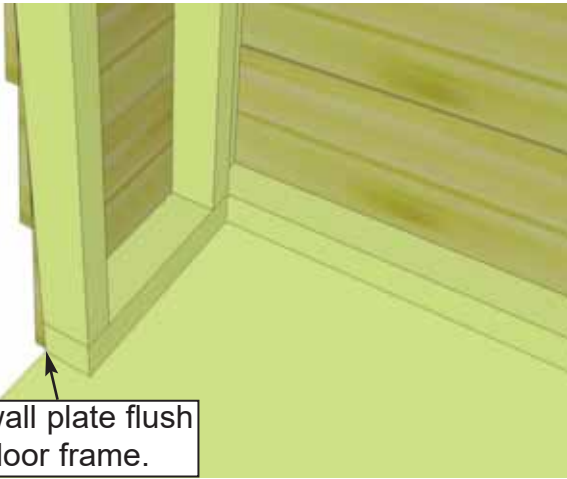

2x3 wall plate flush with floor frame.

16. Once again position the 2x3 wall plate so it sits flush with floor framing and siding overhangs.
Note: Narrow Wall Panel is only 73" high.

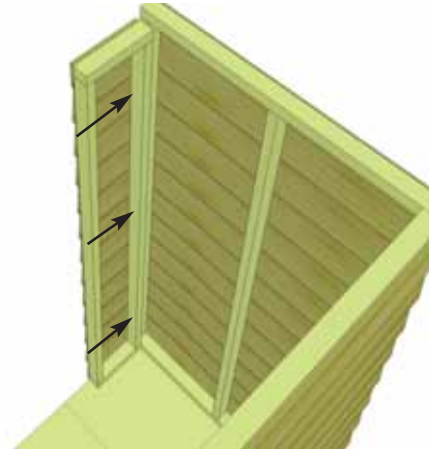

17. When correctly positioned, secure Narrow Wall Stud to Side Wall Stud with **3 - 2 1/2" Screws**.



18. Align front corner Window Wall Panel as per **Steps 11 & 12**, using **3 - 2 1/2" Screws** to secure wall studs together.

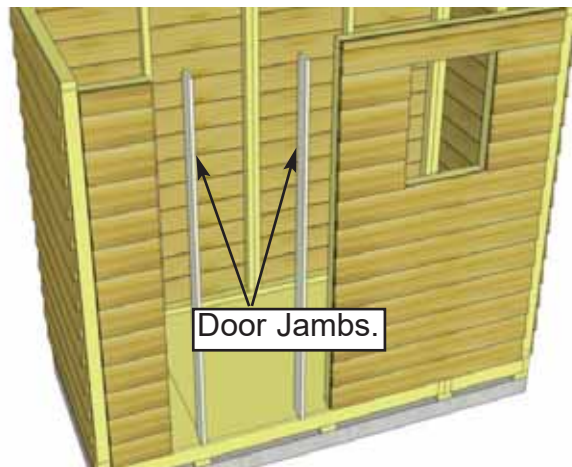

Door Jambs.

19. Locate **Door Jambs** (2 @ 3/4" x 3 1/2" x 73") and place on either side of door opening.

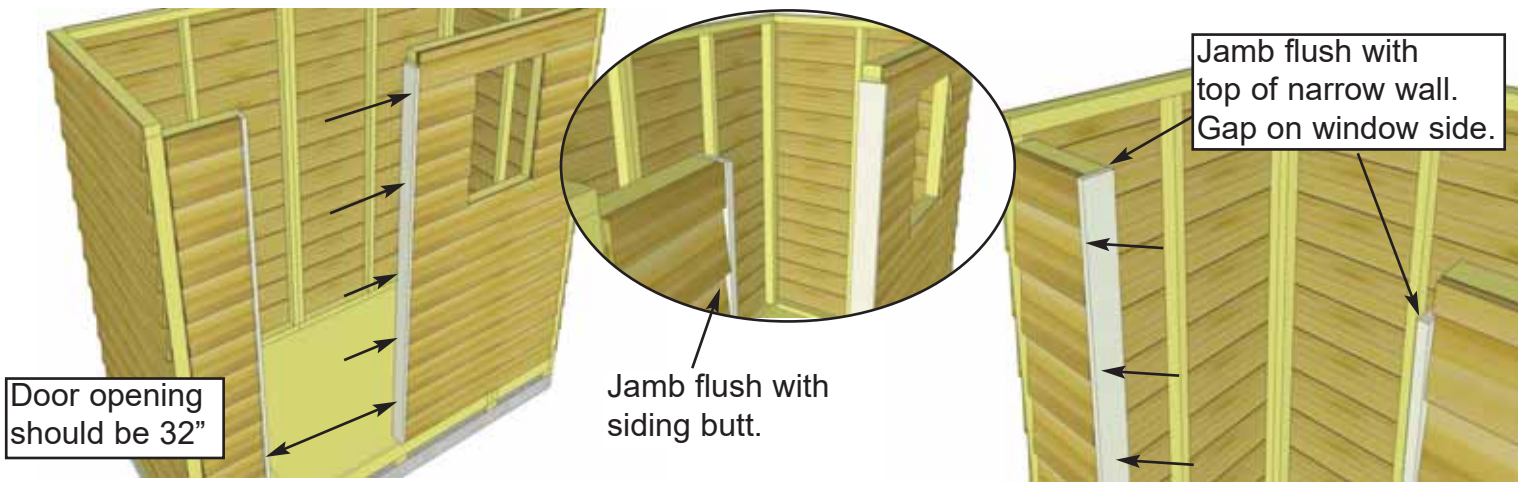

20. Position Door Jambs flush against narrow and window wall studs and tight to floor. The Jamb is 3 1/2" wide and will sit flush to outside of wall siding. When positioned correctly, secure Jambs using 4 - 2 1/2" Screws. With both door jambs secured, confirm 32" door opening.

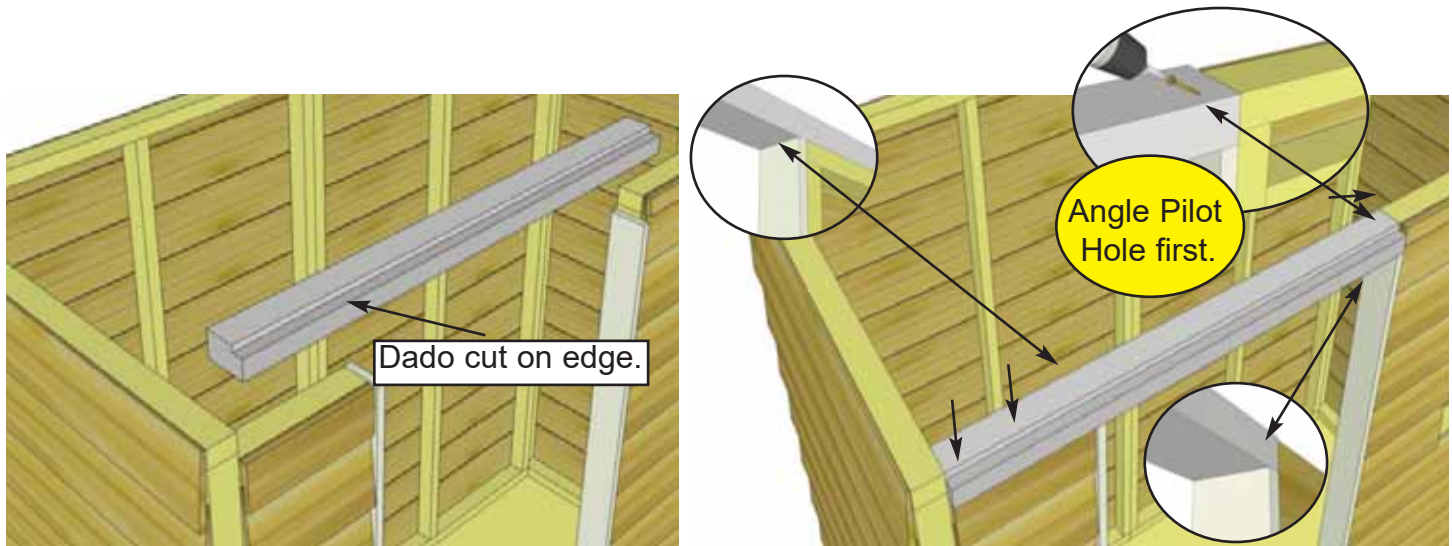

21. Position and attach the **Door Header** to top of Narrow Wall framing and against window wall framing resting on top of door jambs. Header should sit flush on Door Jambs. Attach with 4 - 2 1/2" Screws. On window side, screw about 1" from end of header at angle into window wall framing. Pilot hole first.

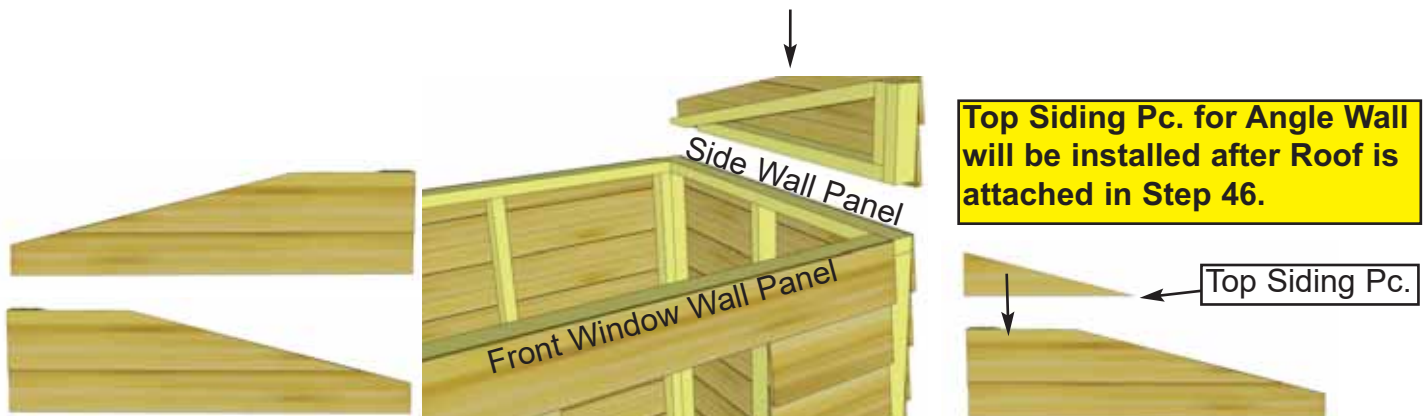

22. Locate both **Angled Wall Extenders (L/R)**. Place first wall extender on side wall panel frame. **Note:** Bottom siding of wall extender will overhang and cover siding of side wall.

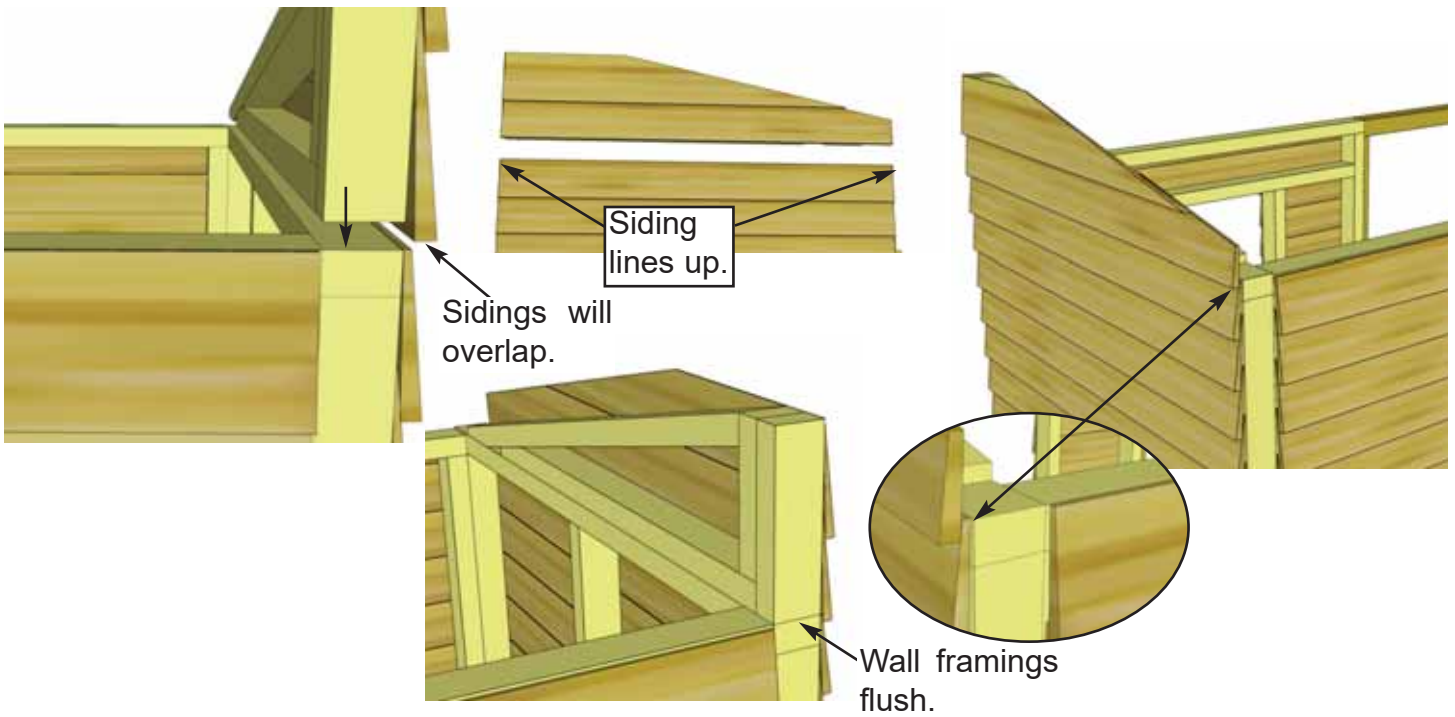

23. Align wall framing of Angled Wall Extender and Side Wall so they are flush at the back. The siding for both walls should also align evenly from front to back.

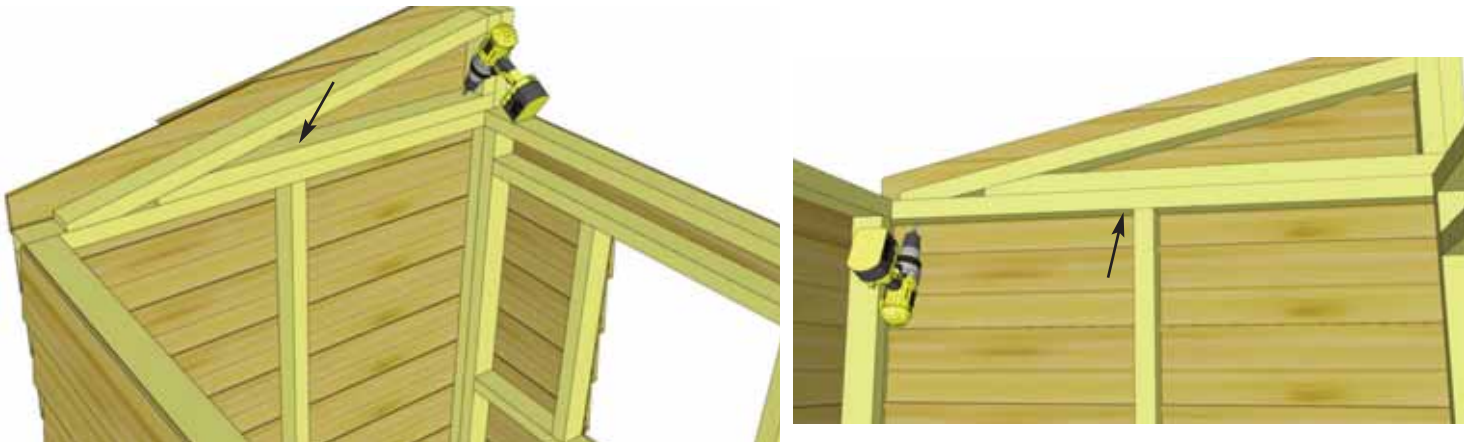

24. With Angled Wall Extender and Side Wall aligned correctly, secure together from the inside with 4 - 2 1/2" Screws.

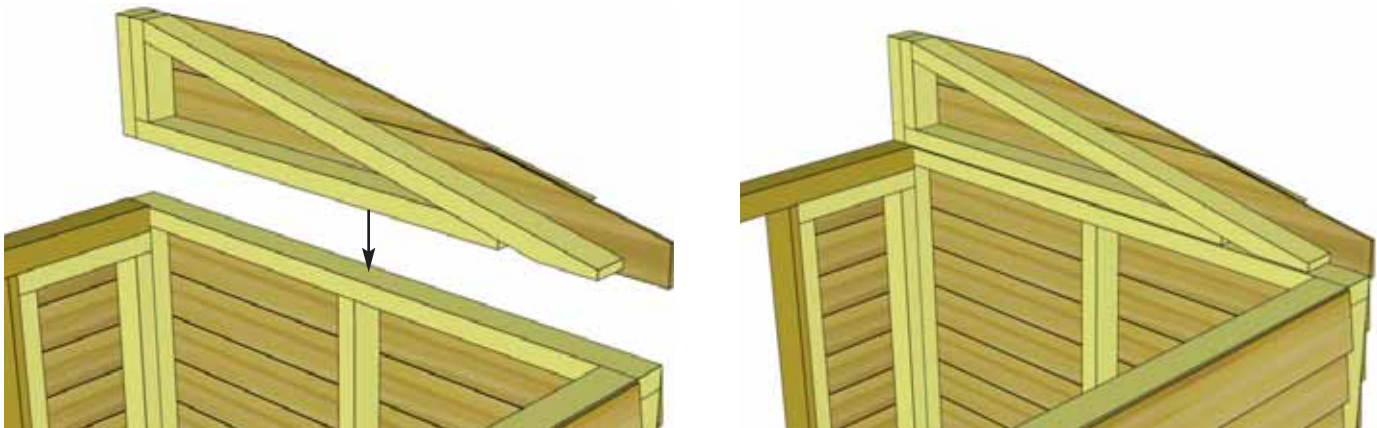

25. Complete opposite Angled Wall Extender positioning and attachment as per **Steps 23 & 24.**

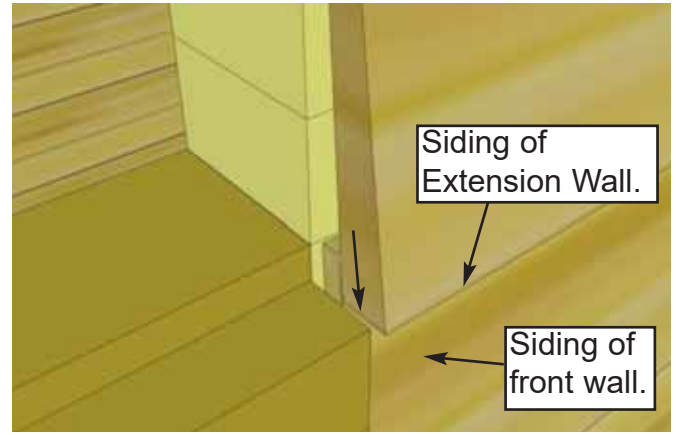
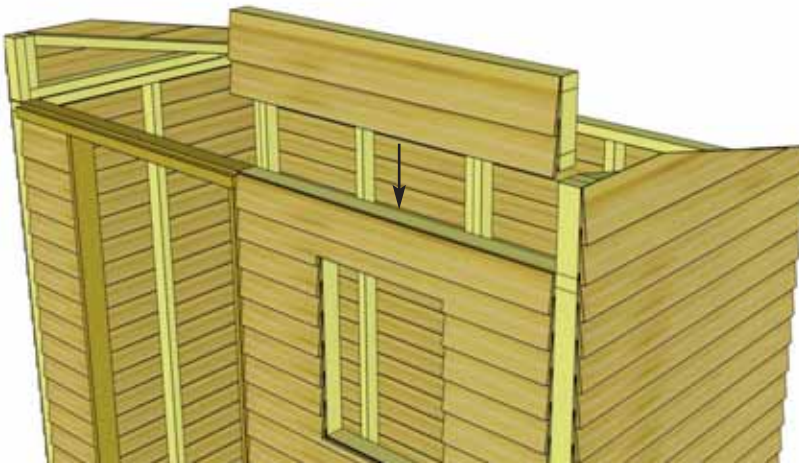

26. Locate one **Wall Extender** and place on front window wall panel with siding of extender overlapping that of the front window wall.

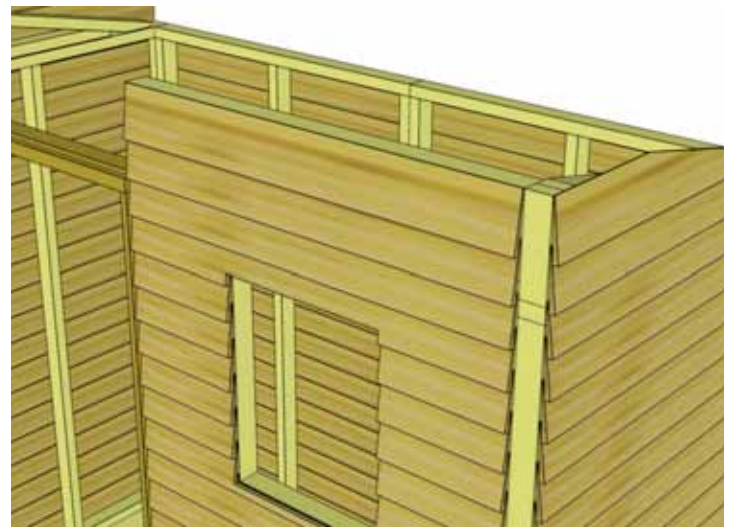
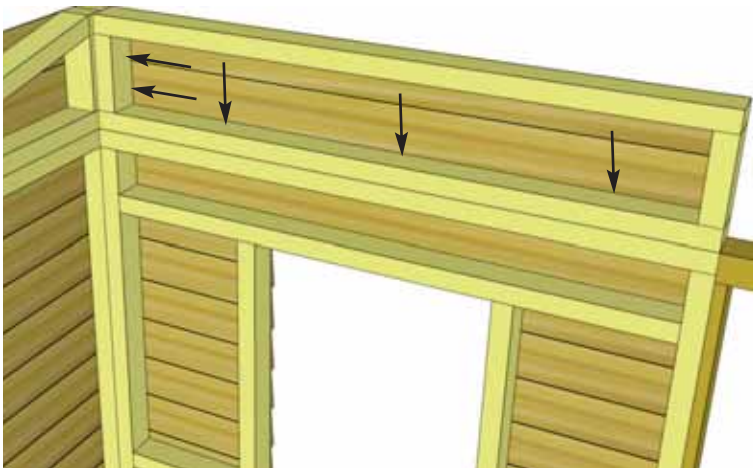

27. With 2x3 wall framing aligned, attach Wall Extender to both the Angled Wall Extender framing and the front window wall framing with **5 - 2 1/2" Screws**.

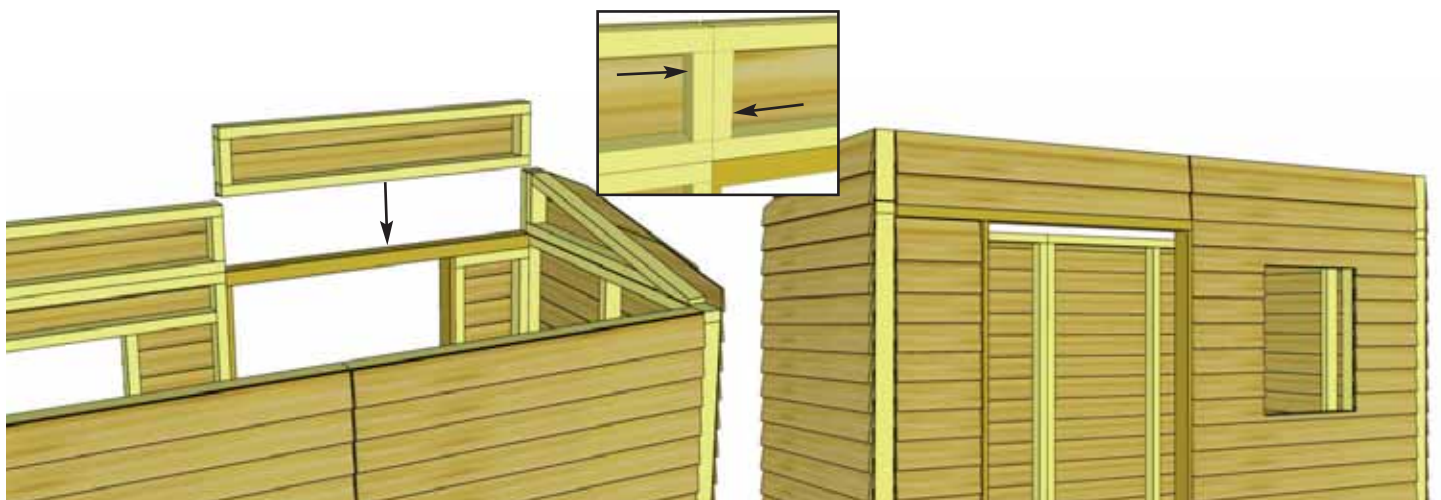

28. Position and secure 2nd Wall Extender Panel as per **Steps 26 & 27**. Additionally, attach to first Extender with **2 - 2 1/2" Screws**.

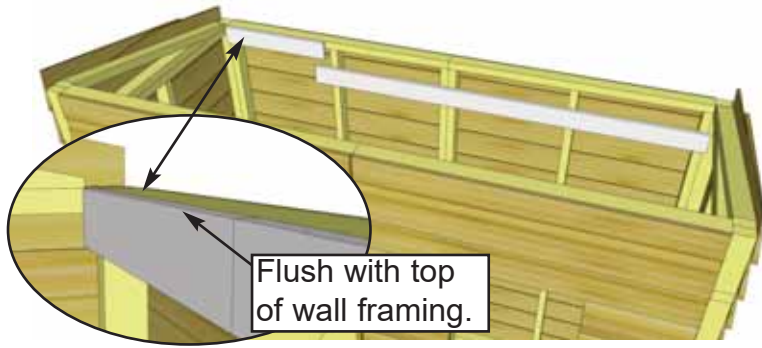

Flush with top of wall framing.

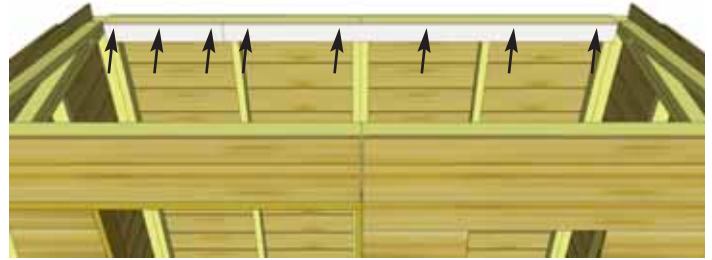

29. Align **Horizontal Wall Cleats** (1 @ 3/4" x 3 1/2" x 70", 1 @ 3/4" x 3 1/2" x 21") flush with top of Rear Wall framing. To help strengthen the Rear Walls, there is a short and a long wall cleat which meet off-center from the seam between walls. Attach Cleats with **8 - 1 1/4" Screws**.

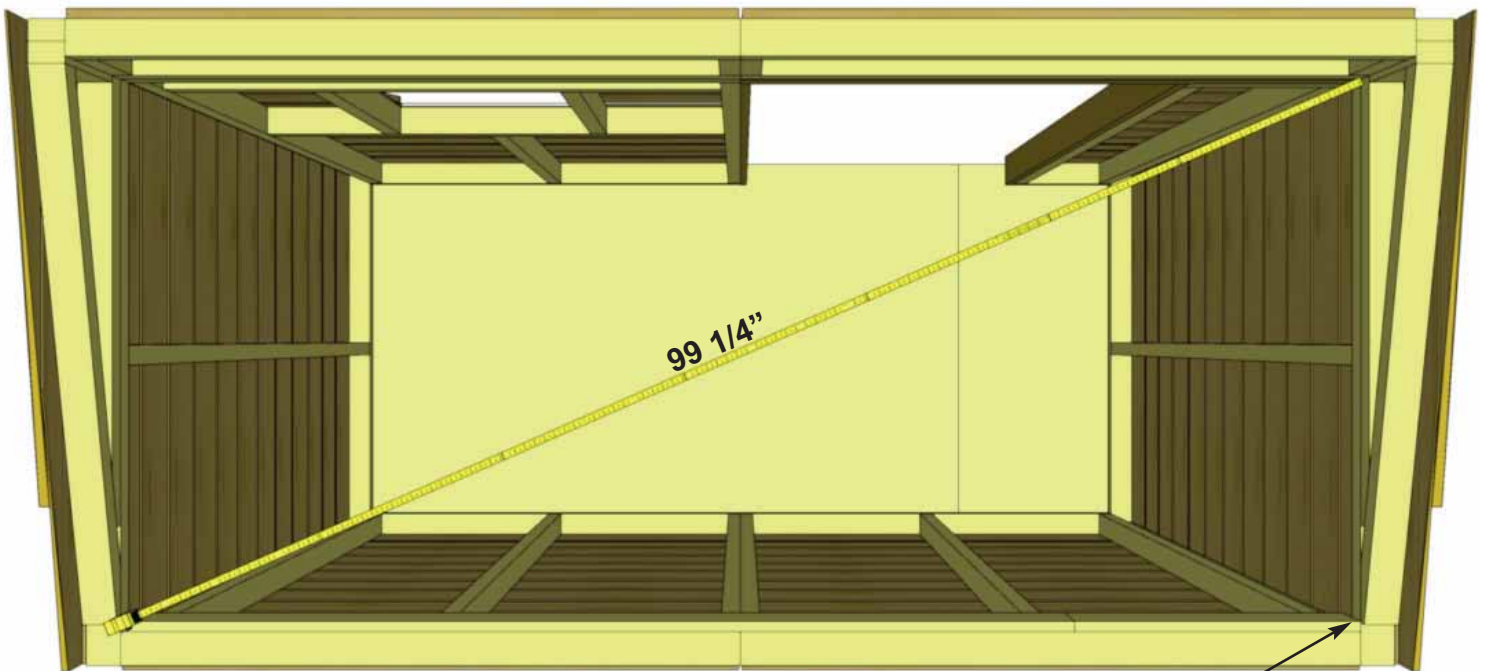

Advice: Prior to fastening walls and installing rafters, take time to confirm your walls are level, square and plumb.

Measure diagonal at top and bottom of walls corner-to-corner. This should be approximately 99 1/4". More importantly, if measurements are not within 1/4", your walls are not square. Adjusting now will make it easier to install roof section.

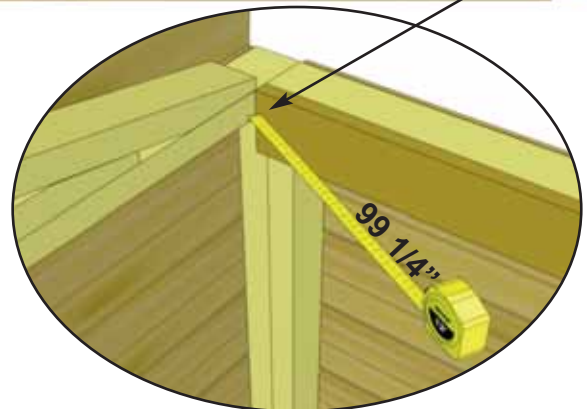

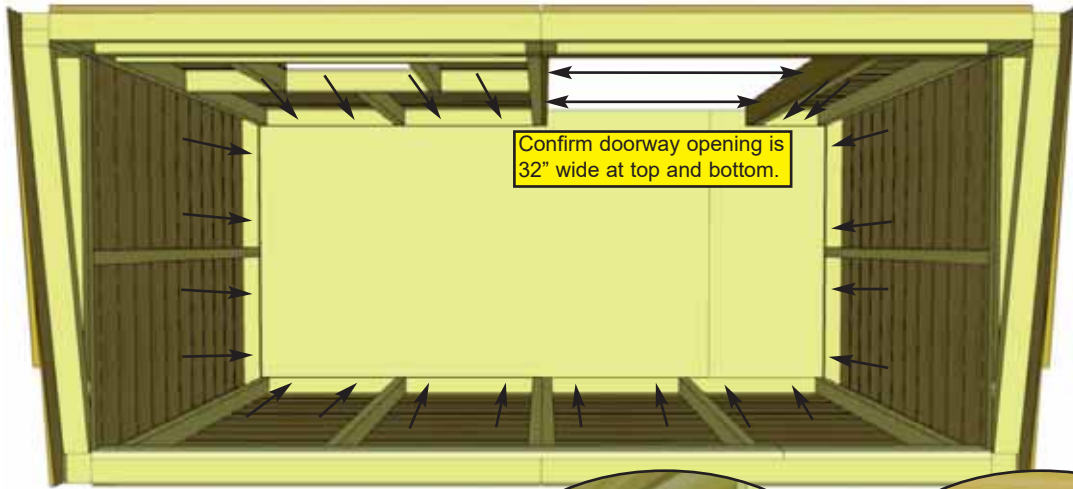

Optional - Caulking seams will help prevent moisture from entering at seam. Caulking not included in kit.

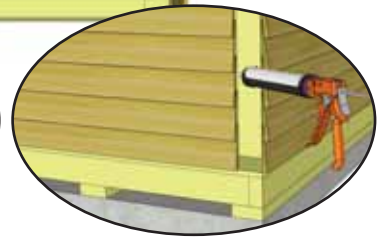
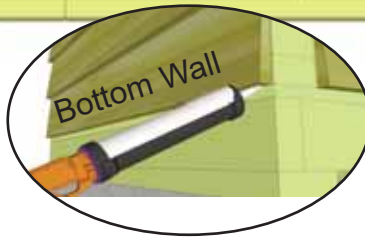

30. To complete Wall Section, attach bottom 2x3 wall plates to plywood floor with **22 - 2 1/2" Screws**. Confirm Doorway opening is 32" wide. Prior to securing, make sure wall panels are aligned correctly on the floor. Refer to **Step 11**. Wall siding should overhang floor while 2x3 wall plates should sit flush with floor.

C. Rafter and Roof Section

Exploded view of all parts necessary to complete the Rafter and Roof Section. Identify all parts prior to starting.

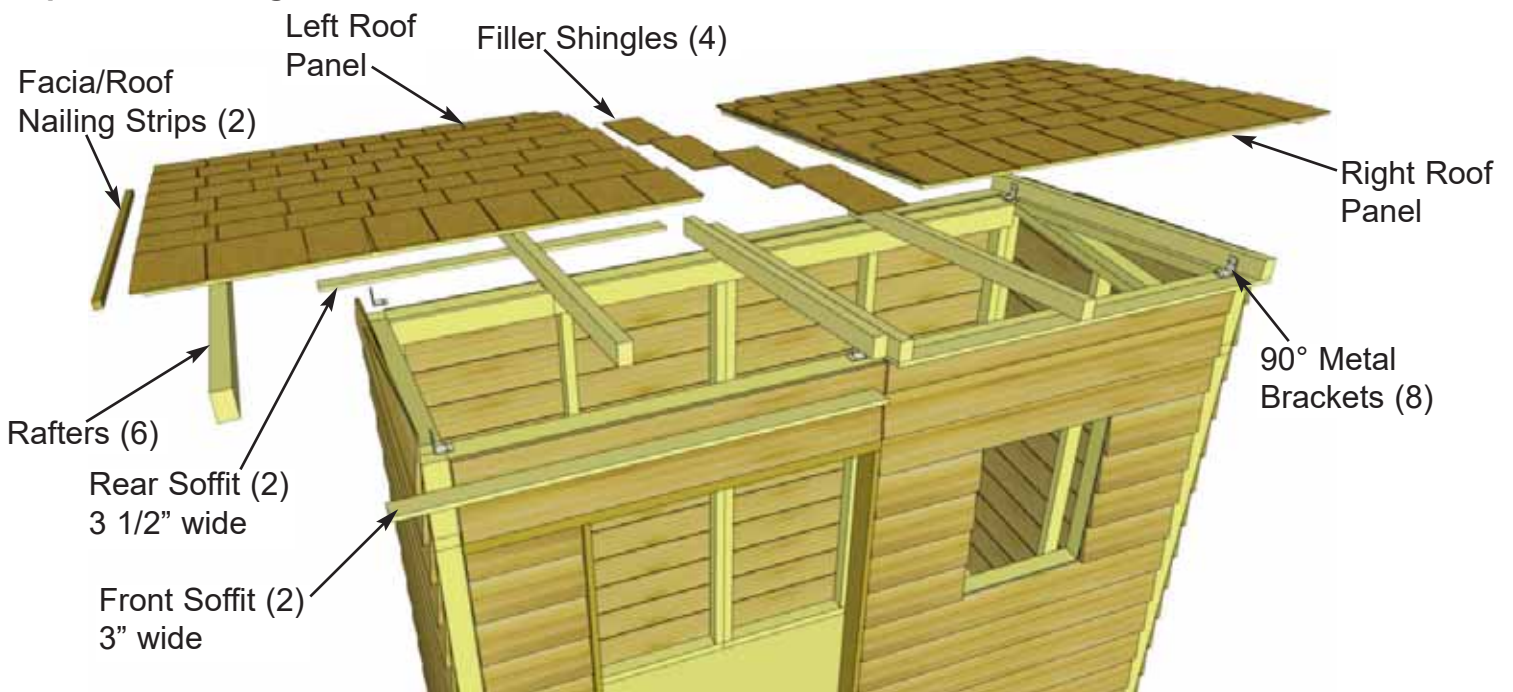

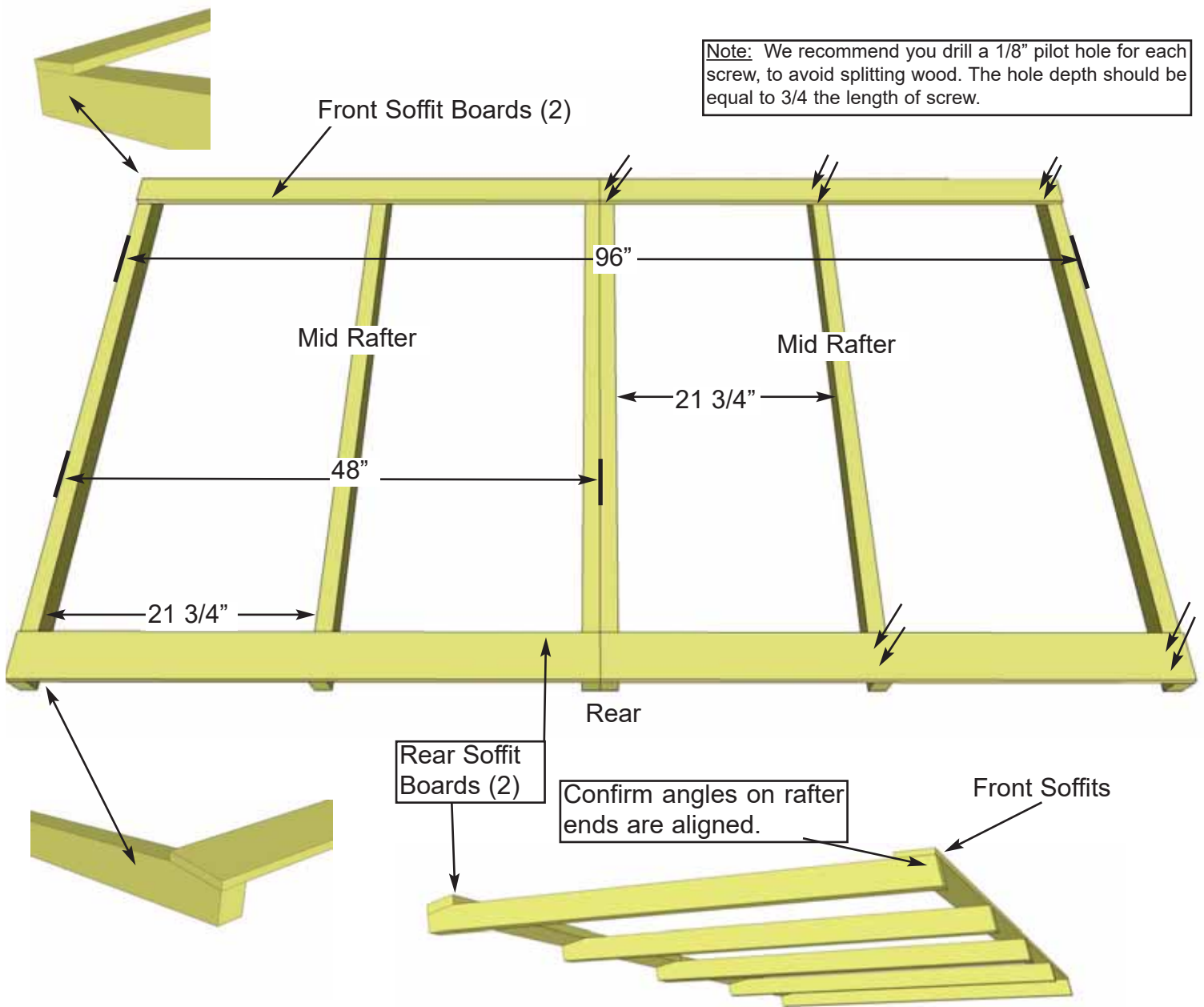

31. Locate 6 Rafters, 2 Rear Soffits and 2 Front Soffits. Lay out on level ground and assemble as shown in Illustrations A through C below. Attach Soffit Boards flush to end of outside rafters with 2 - 1 1/4" screws per rafter end. **Important:** Drill pilot holes in Soffit ends to prevent splitting. Measure and attach interior Rafters as illustrated above. Measure and attach remaining Soffit/Rafter connections using 2 - 1 1/4" screws per rafter/soffit.

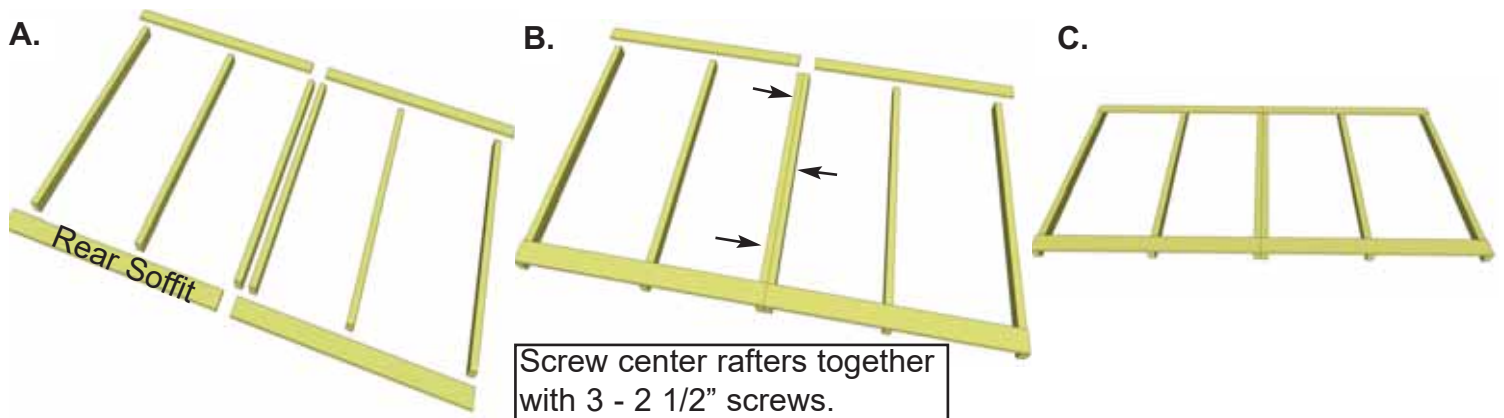

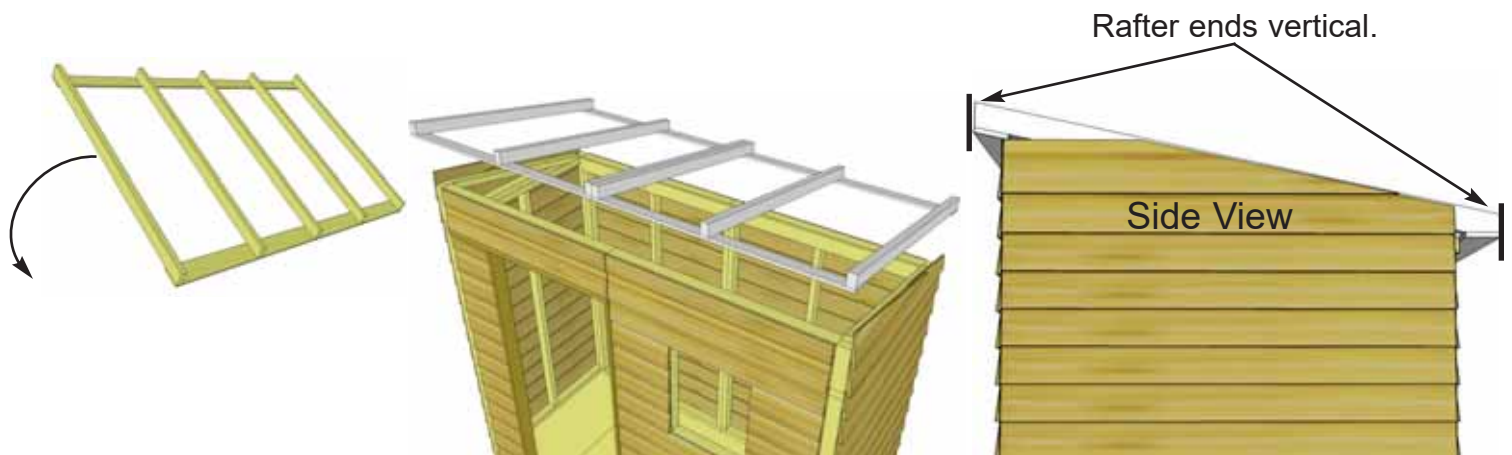

32. Carefully flip completed Rafter Section over so Front Soffit is facing the front and place on GardenSaver walls. **Note:** Double check that your Rafter Section is positioned correctly by ensuring the ends of the Rafters are sloped vertically as shown above.

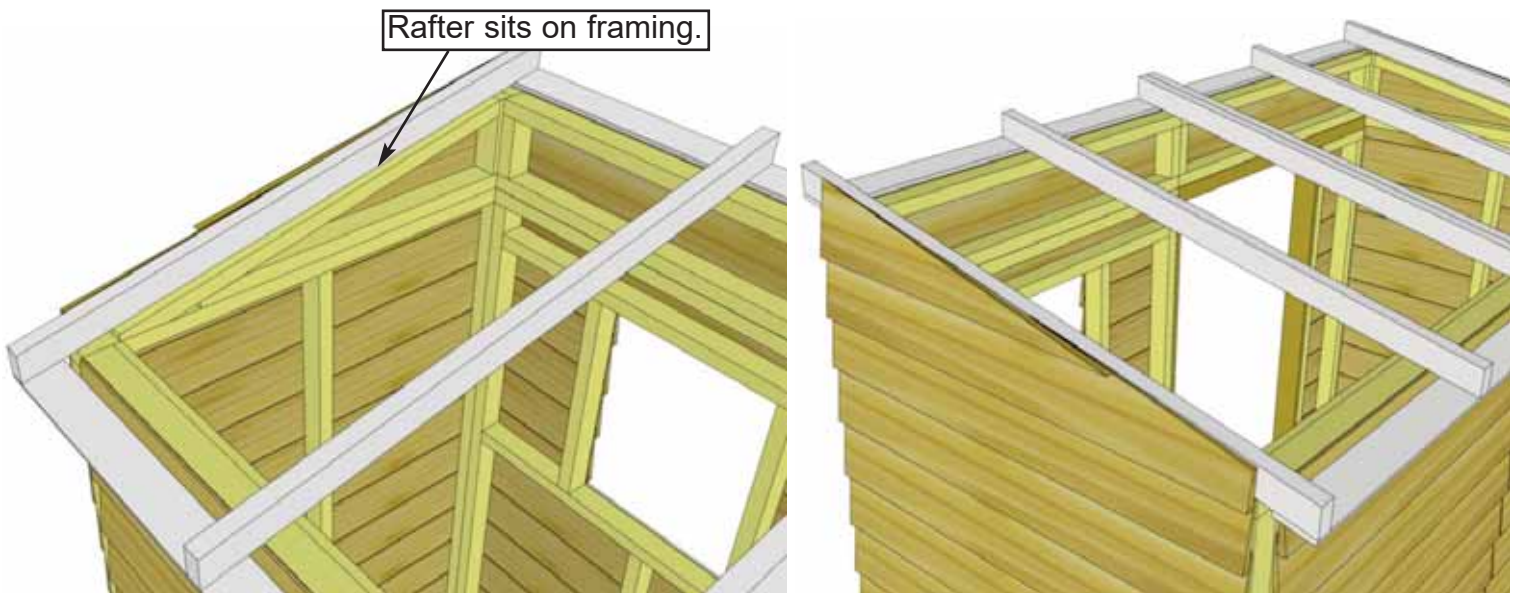

33. Position completed Rafter Section on top of walls. Outside Rafters will sit on Extension Wall framing and be positioned equally from side to side.

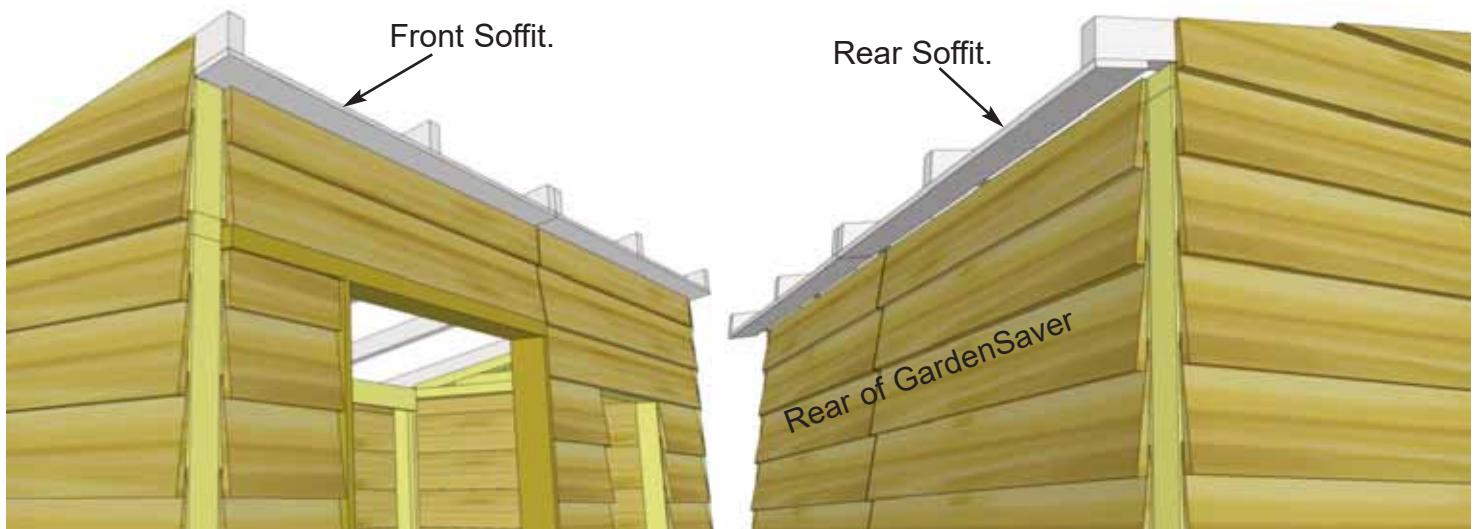

34. When Rafter Section is positioned correctly, Rear Soffits will sit approximately 1/8" away from wall siding. The Front Soffit may touch wall siding. This can vary slightly.



35. With Rafter Section correctly aligned, secure rafters to walls using **90° Metal Brackets**. Start with outside rafters and secure 2 Brackets with **1 1/4" Screws**. Screw into Wall Extension Framing at the front and Wall Panel top framing at the rear. Complete both sides.

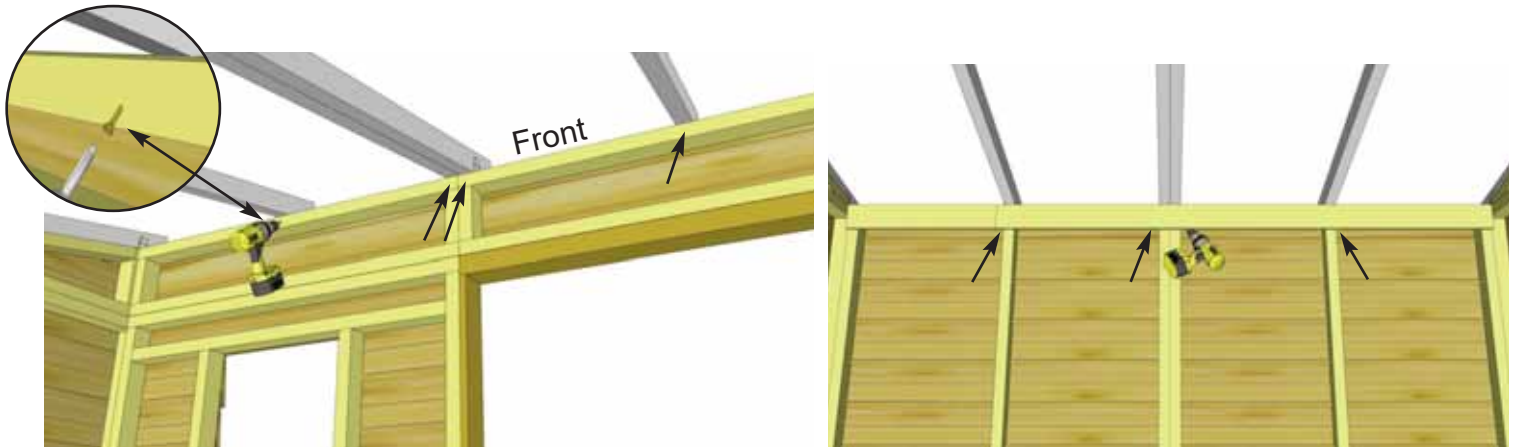

36. With outside rafters properly secured, completely secure remaining interior rafters using **8 - 3" Screws**. Screw into rafters from inside of Extension Wall framing at front of shed and inside Rear Wall framing at rear of shed, behind Horizontal Wall Cleats.

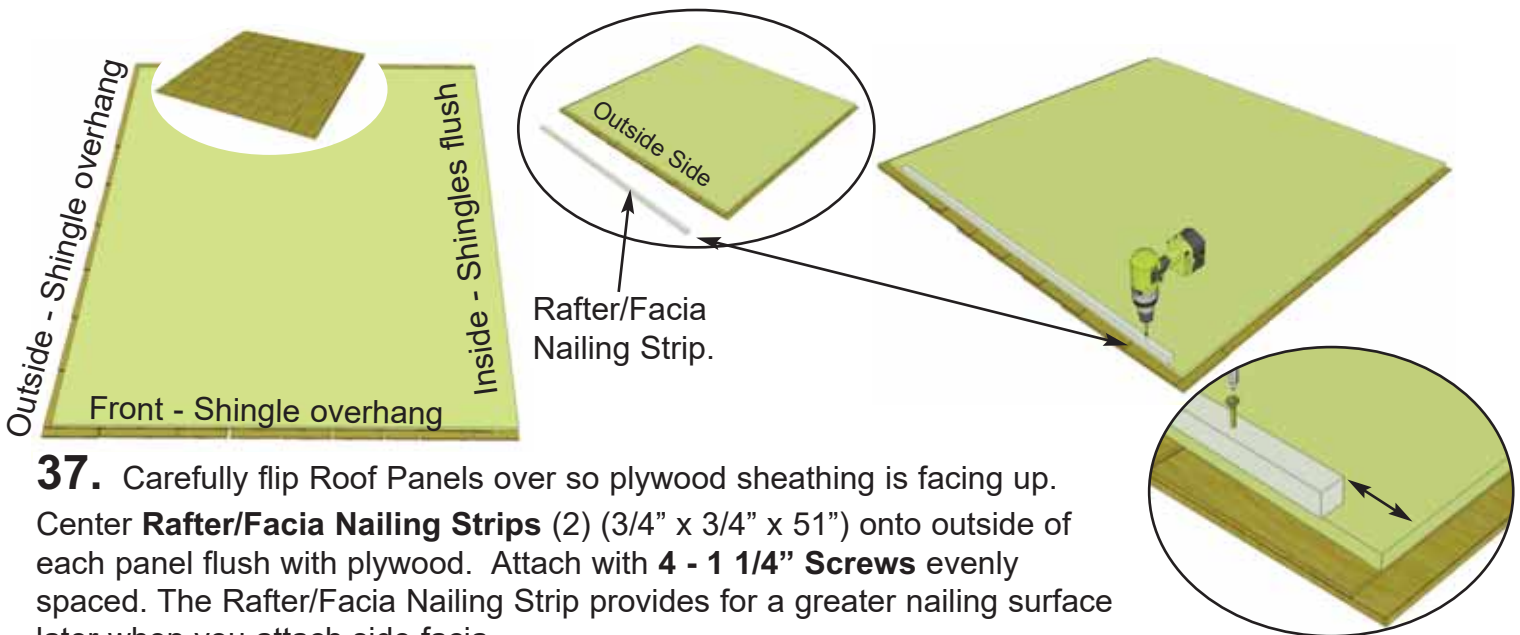

37. Carefully flip Roof Panels over so plywood sheathing is facing up. Center **Rafter/Facia Nailing Strips** (2) (3/4" x 3/4" x 51") onto outside of each panel flush with plywood. Attach with **4 - 1 1/4" Screws** evenly spaced. The Rafter/Facia Nailing Strip provides for a greater nailing surface later when you attach side facia.



38. Correctly orientate Left Side Roof Panel, with shingles overhanging plywood on the side of the shed and flush with plywood to the middle. Place on rafters with front of plywood just about flush with rafter ends but just slightly recessed. Doing so allows front fascia to sit better.

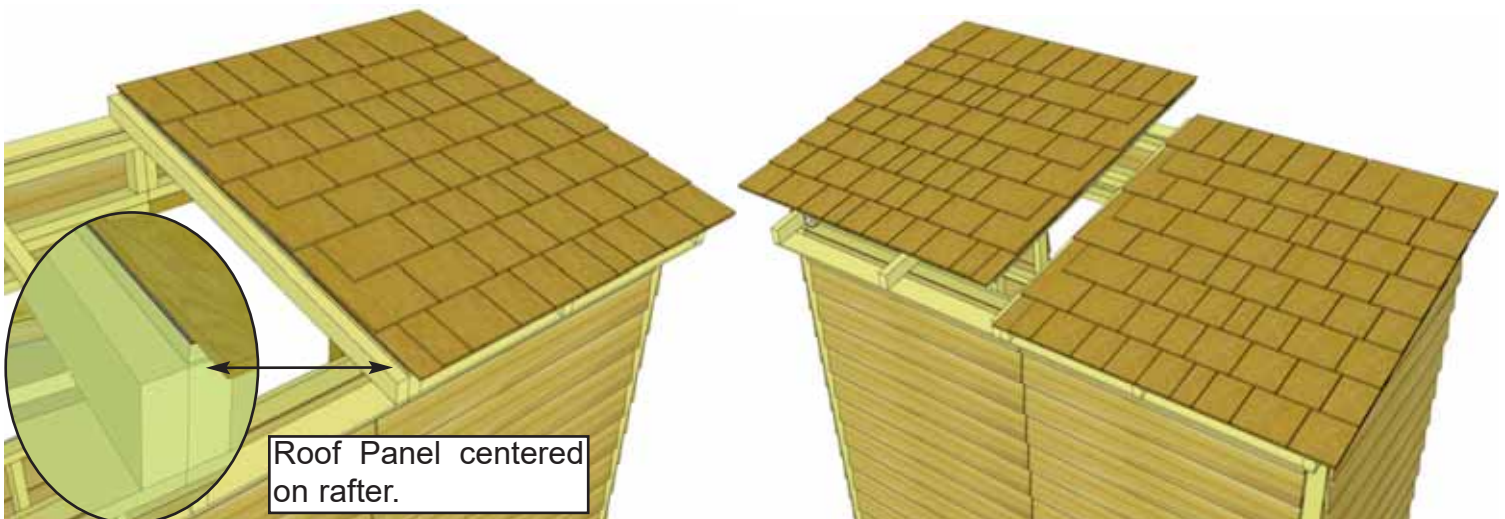

39. For correct Roof Panel position, align panel so plywood sits evenly on Center Rafters. Complete both roof Panels.

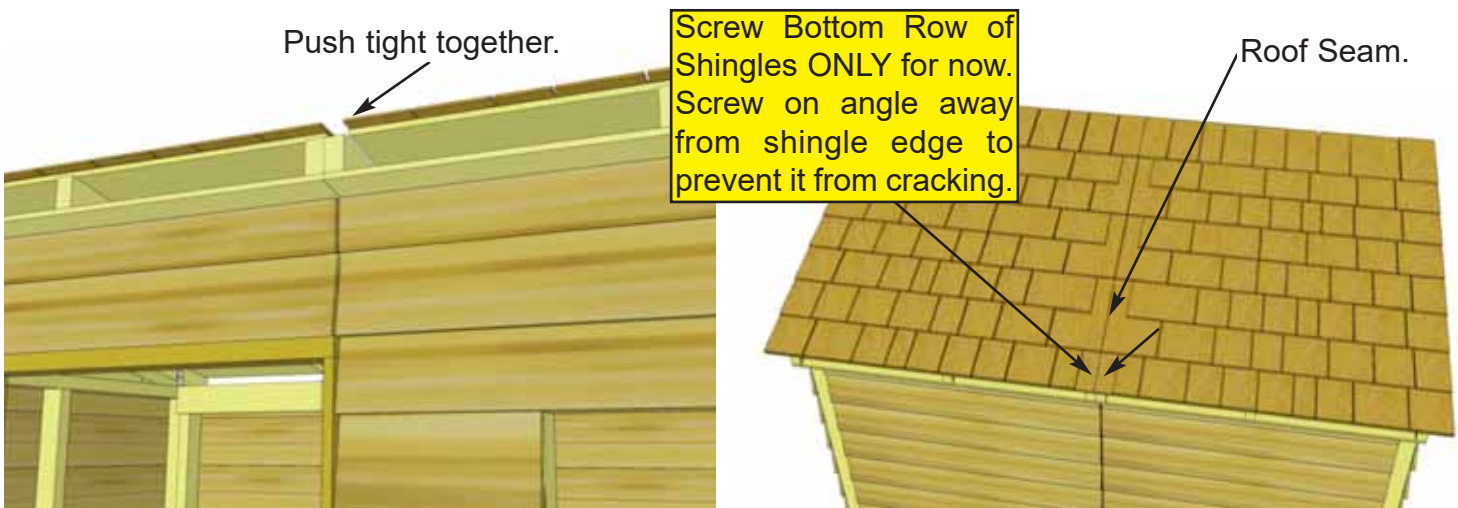

40. With Roof Panels aligned, screw panels down to center rafters with **2 - 2 1/2" Screws** in **Bottom Row of Shingles Only** (1 screw per panel).

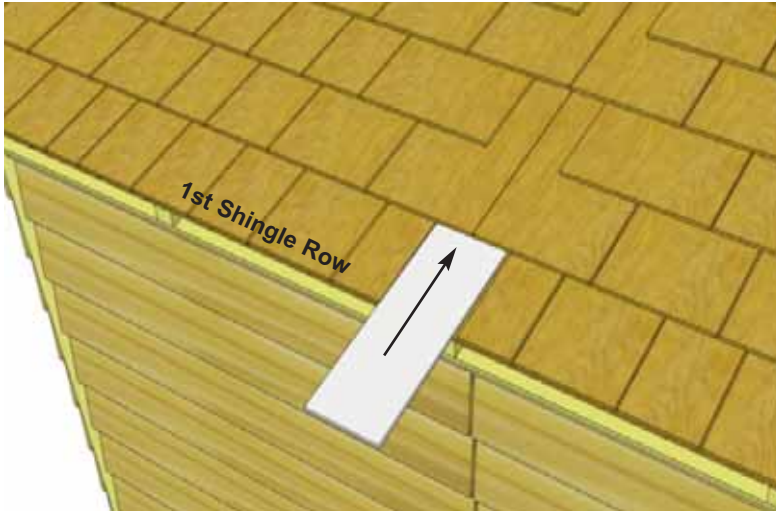

41. To cover roof seam, slide one **Filler Shingle** (5 1/2" wide) up and underneath second shingle row. Push or bang filler carefully with a hammer until evenly spaced and butt is even with other 1st row of shingles.

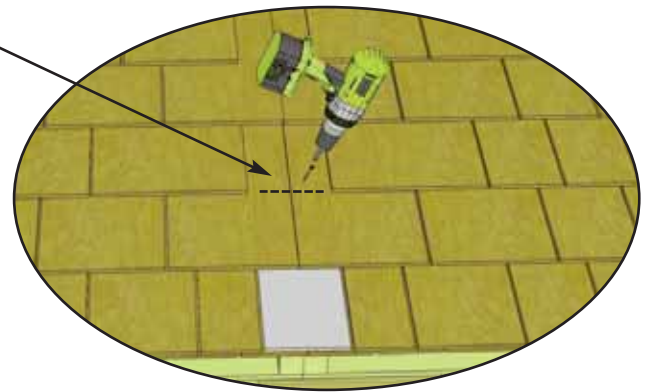
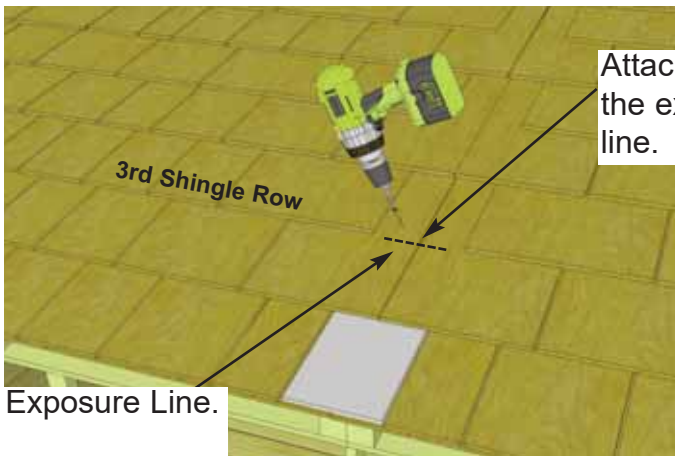
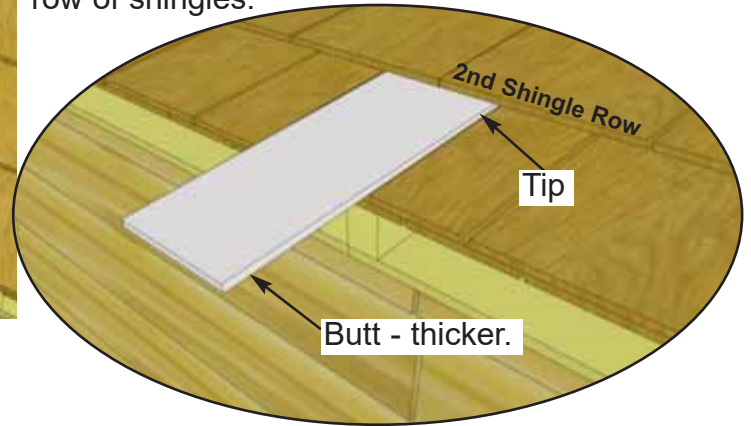

42. Screw first filler shingle down to rafters using **1 - 2 1/2" Screw** per panel (2 in total). Screw on slight angle and make sure to screw into rafter. Screw slightly above 3rd row of shingles (exposure line). This way, the screw will get covered up when you install your 2nd Filler Shingle and will prevent leaking.

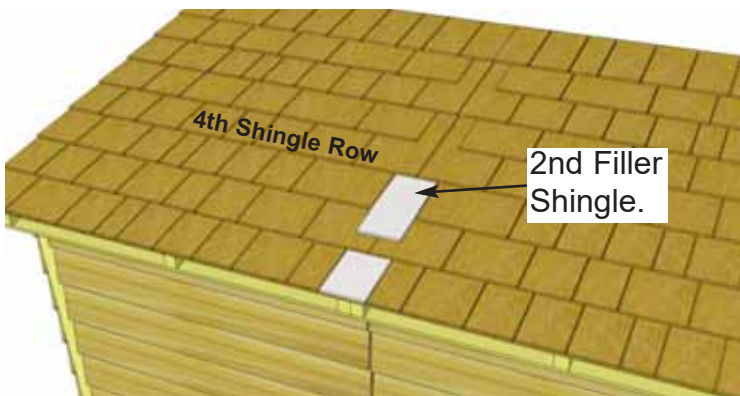

43. Slide 2nd **Filler Shingle** up and underneath fourth shingle row. Follow **Steps 41 - 42** to align and attach.

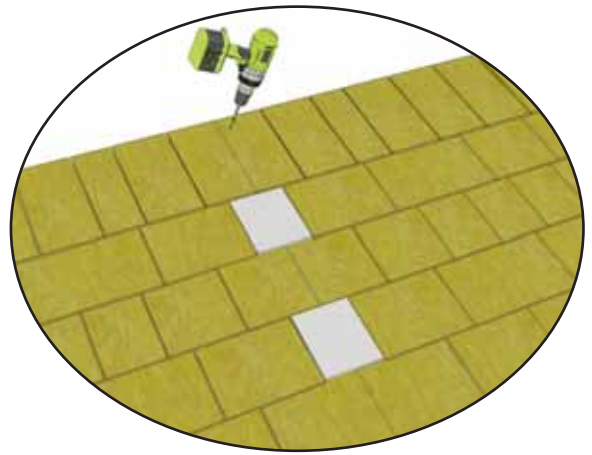
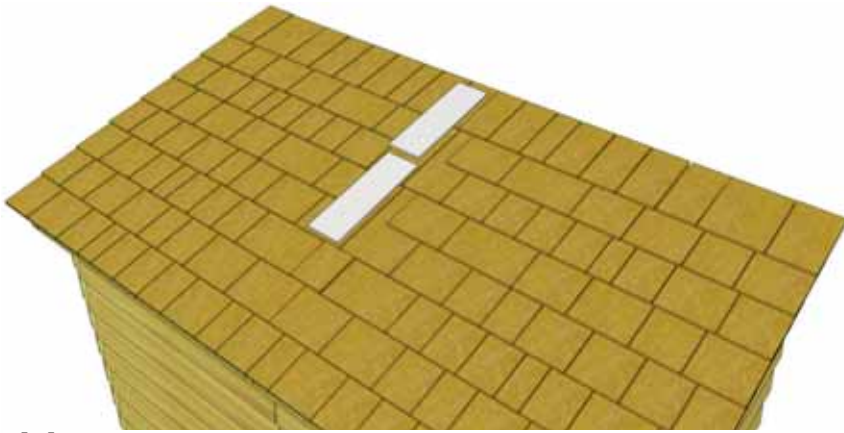

44. Slide 3rd and 4th **Filler Shingles** up and underneath appropriate shingle rows and follow **Steps 41 - 42** to align and attach. On last filler, screws will get covered by Roof Ridge Board (4 1/2" wide).

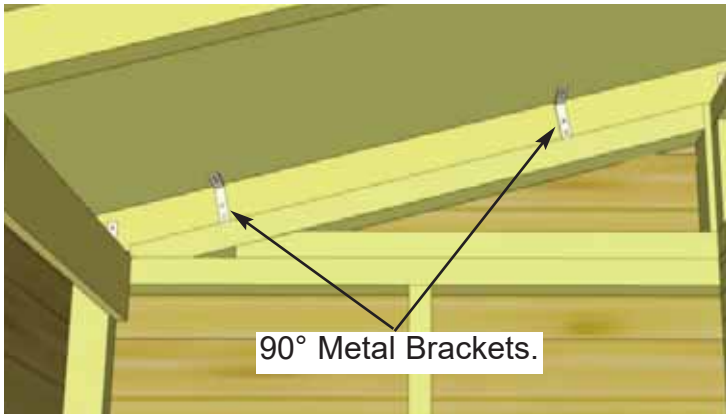

90° Metal Brackets.



45. Secure roof panels to walls at both ends by positioning **2 - 90° Metal Brackets** on plywood and outside rafters. Secure with **4 - 1 1/4" Screws** per Bracket, complete both sides.

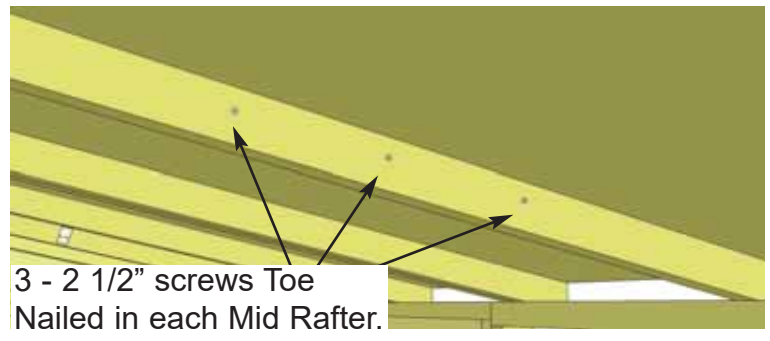
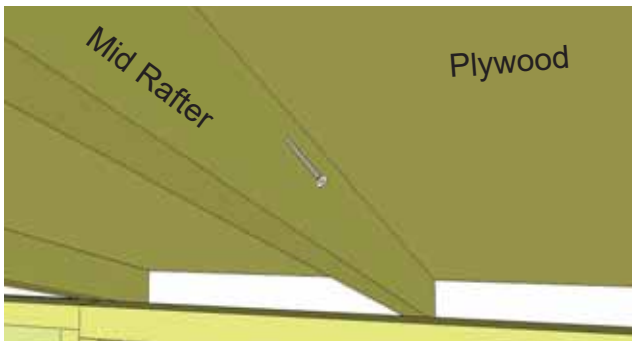

3 - 2 1/2" screws Toe Nailed in each Mid Rafter.

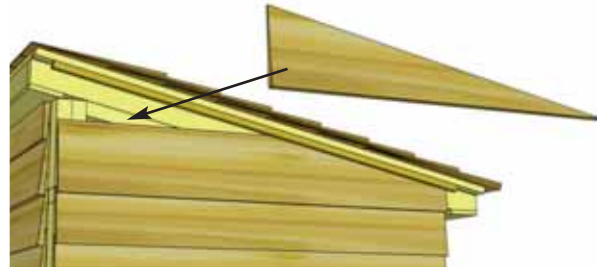
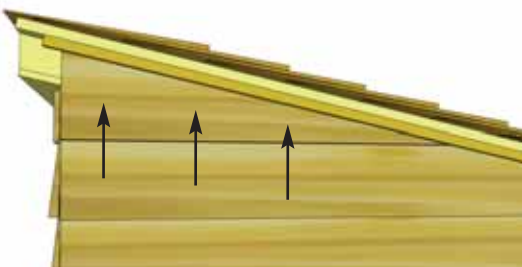

46. To further secure roof panels from the inside, drill pilot holes on an angle in each panel's Mid Rafter (3 per Rafter). Using **3 - 2 1/2" Screws**, secure rafters to plywood.

Note: from outside if possible, have a helper push roof panel down so plywood sits flush against rafter while securing. Locate **Top Siding Piece for Angled Wall Extender (L/R)**. Position top siding on wall extender and align as shown above. Attach with 3 - 1 1/2" finishing nails to top wall framing. There are left/right top siding pieces. Use rough surface side out.

D. Miscellaneous Section

Exploded view of all parts necessary to complete the Skirting, Trim, Facia and Miscellaneous Pieces. Identify all parts prior to starting.

(Not Shown: Door Stops)

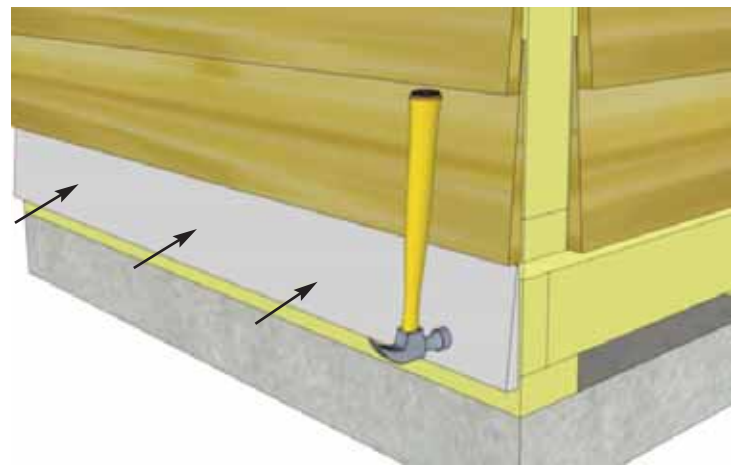
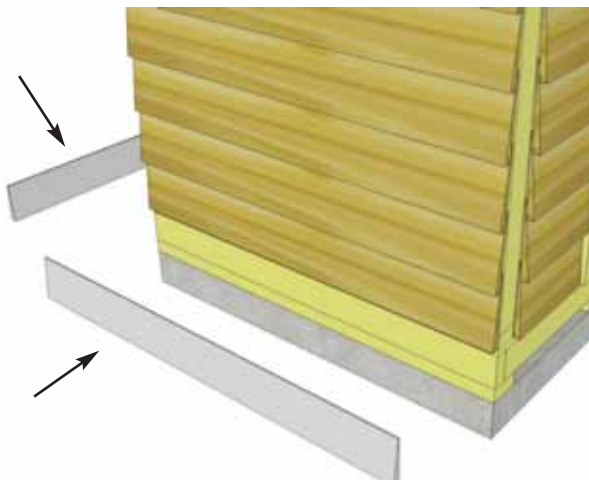
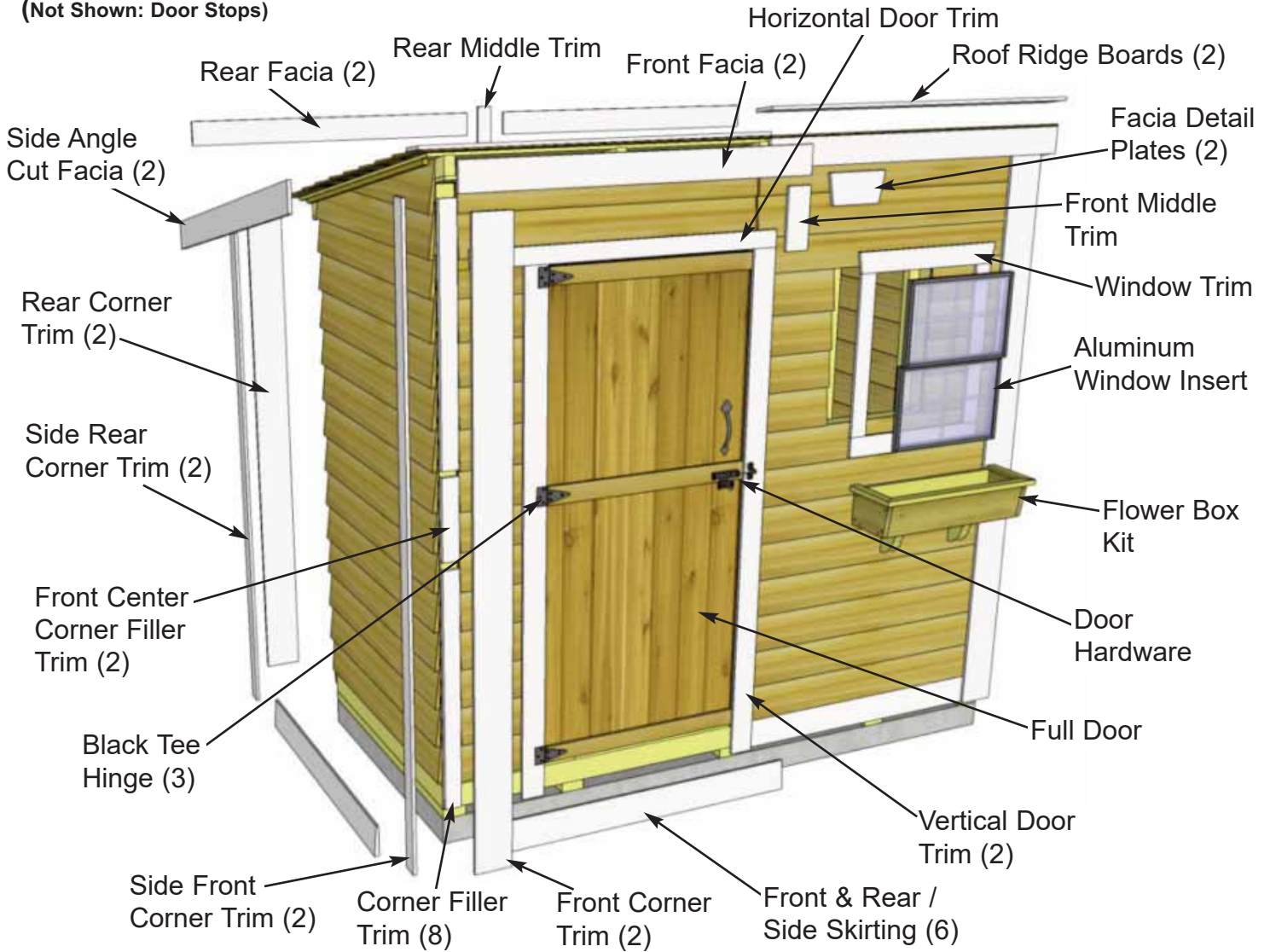

47. Attach **Bottom Skirting** (3/4" x 4 1/2" x 45 1/4" - bevel) around the base of the shed. Skirting will hide floor framing. Start with side skirting pieces first and attach with **4 - 1 1/2" Finishing Nails** per piece.

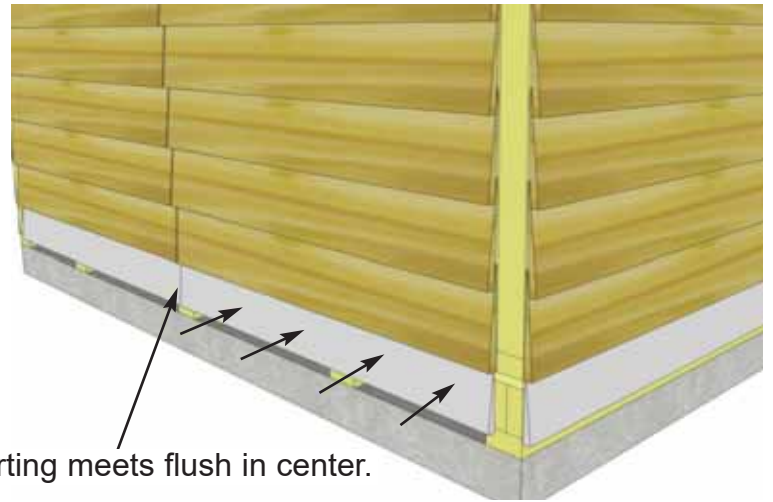

48. Rear skirting pieces will meet together in the center. Secure with **4 - 1 1/2" Finishing Nails** per piece.

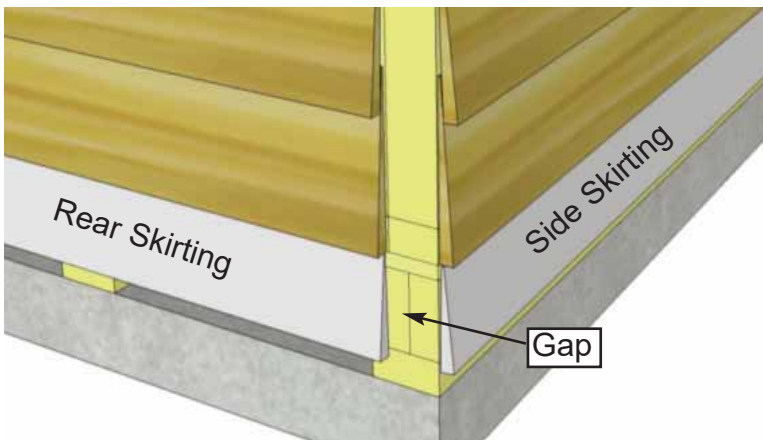

49. Gaps on outside will be covered by Corner Trim pieces later. Complete front and side skirting attachments.

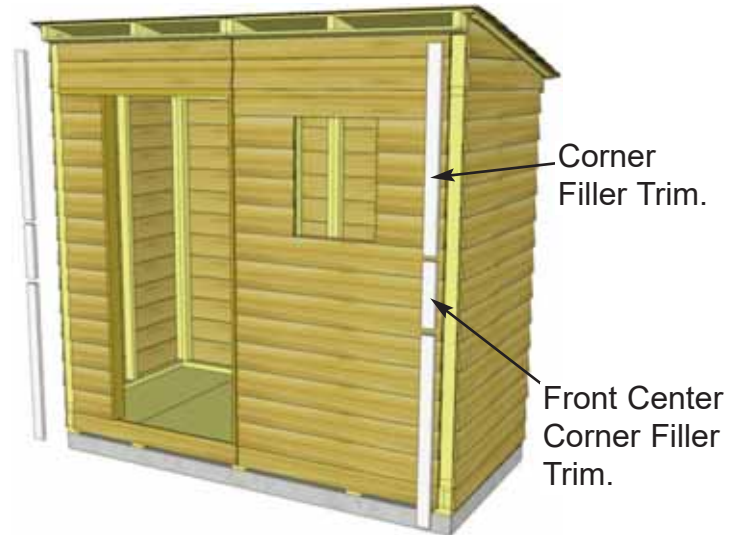
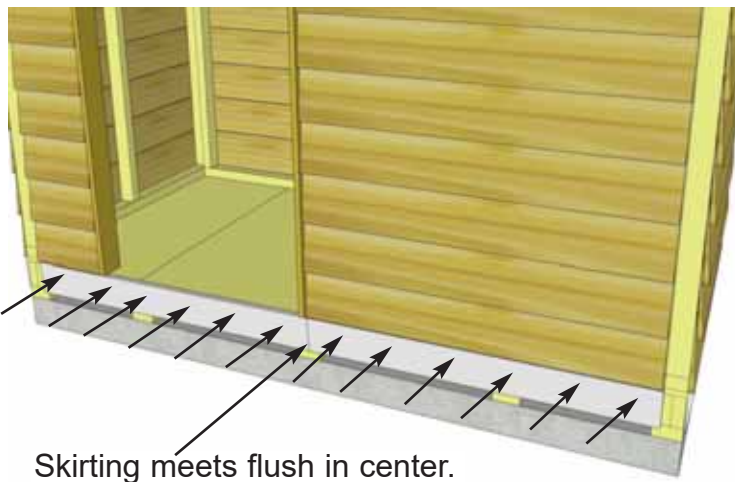

50. Use **6 - 1 1/2" Finishing Nails** on front skirting piece where doors will be installed. This adds extra support to a high traffic area.

51. Locate **Corner Filler Trims** (8 - 7/8" x 2 1/2" x 36") and **Front Center Corner Filler Trims** (2 - 7/8" x 2 1/2" x 10"). Fillers are essentially nailing strips and will not be visible once additional corner trims are attached later.

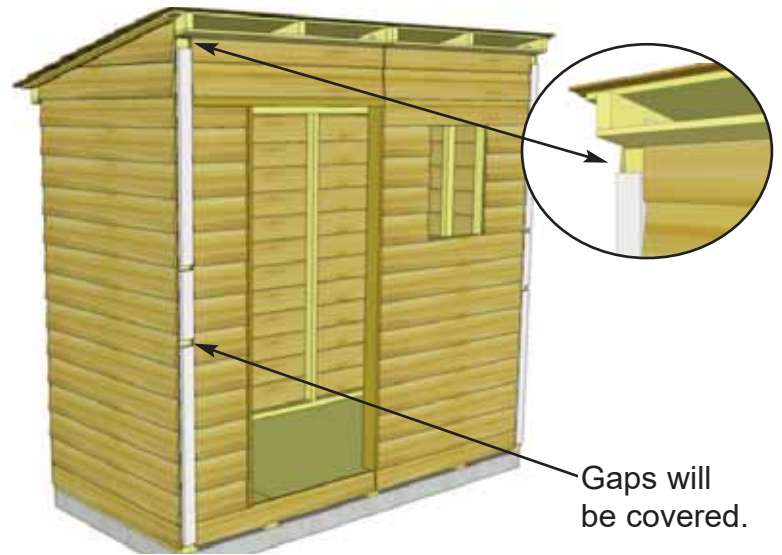
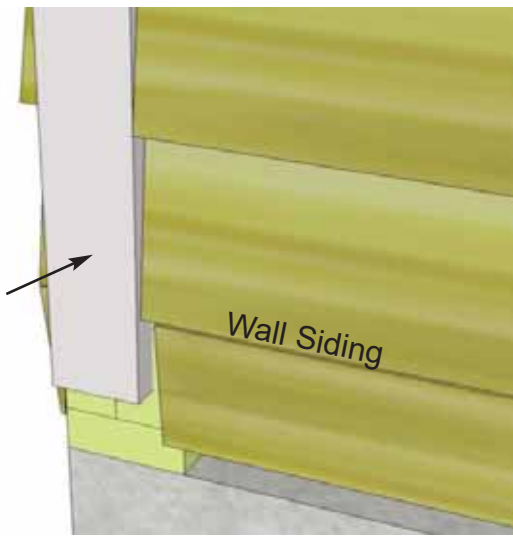

52. Attach **Corner Filler Trims** where gaps exist in front corners (2 per side). Hammer with **8 - 1 1/2" Finishing Nails**. There is an additional 10" long **Front Center Corner Filler Trim** that you will need to center and attach as well using **2 - 1 1/2" Finishing Nails**.

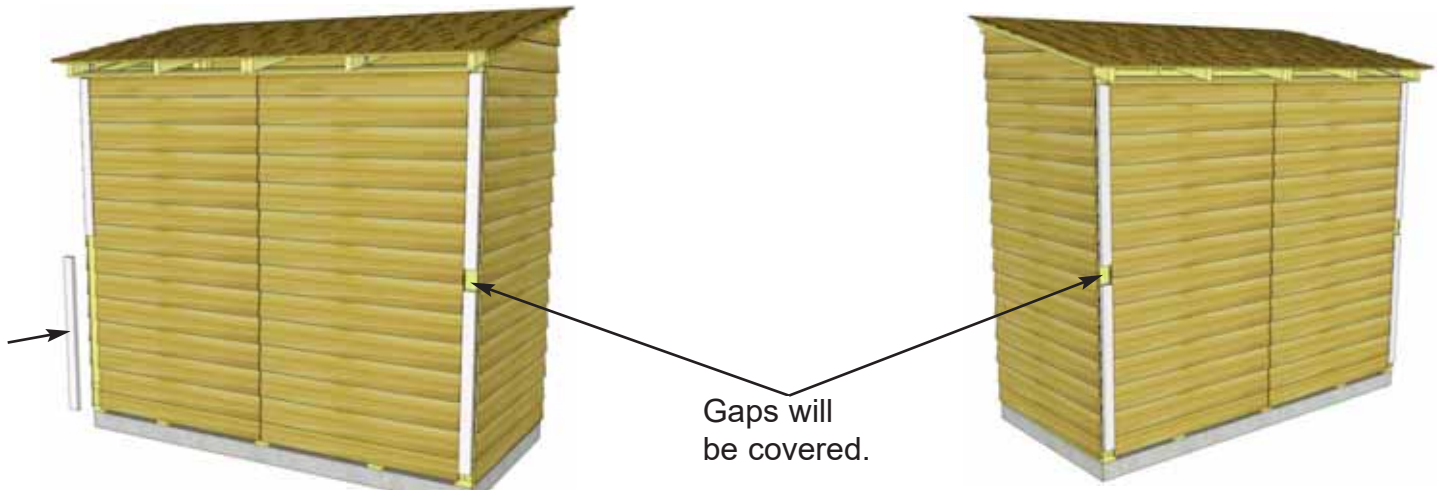

53. Position and attach **Corner Filler Trims** in the rear as per **Step 52**.

54. To completely trim out front corners, locate a **Side Front Corner Trim** (1/2" x 2 1/2" x 88 3/4") and a **Front Corner Trim** (1/2" x 5 1/2" x 88 3/4").



55. Place both trims in front corner and align as illustrated. Do a dry run prior to attaching to achieve best fit. Start with 5 1/2" wide Front Corner Trim and align tight underneath soffit to determine vertical height. Attach with 8 - 1 1/2" Finishing Nails per piece. Position and attach Side Front Corner Trim (2 1/2" wide) using 8 - 1 1/2" Finishing Nails, aligning at bottom with wide trim.

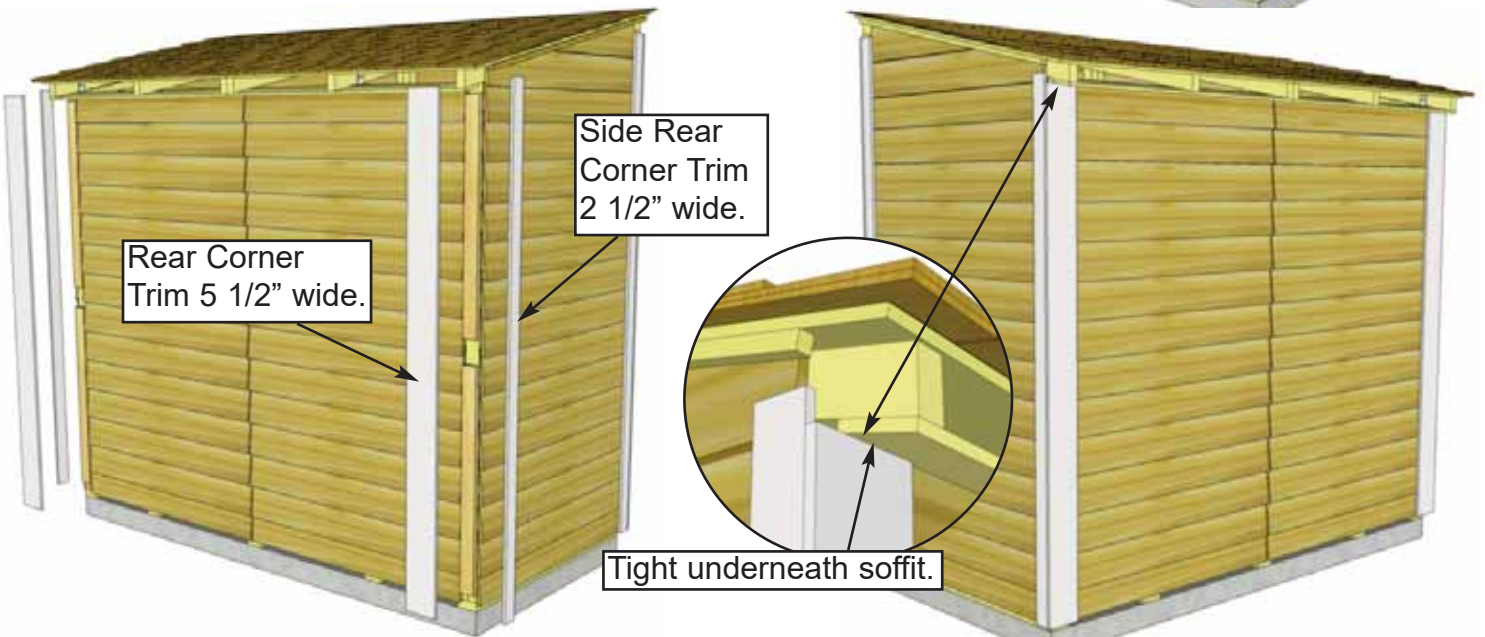
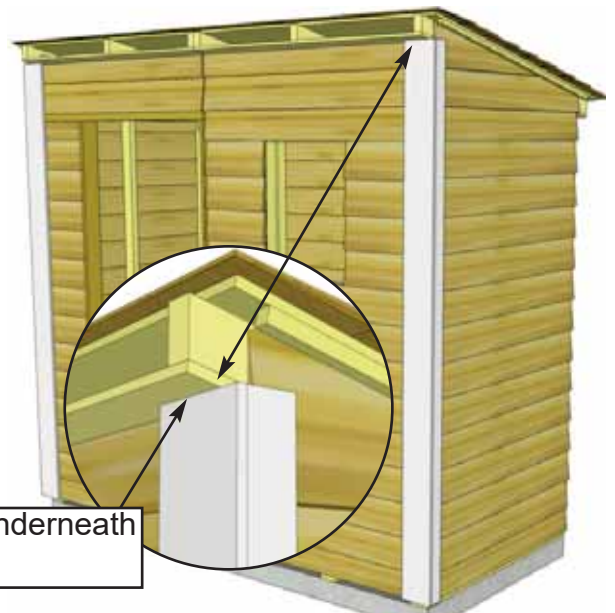

56. To completely trim out rear corners, locate **Side Rear Corner Trims** (1/2" x 2 1/2" x 80") and **Rear Corner Trims** (1/2" x 5 1/2" x 79"). Align and attach as per **Step 55**.



57. Attach **Rear Middle Trim** (1/2" x 2 1/2" x 79") where wall panels come together at rear seam. Attach with 8 - 1 1/2" Finishing Nails aligning tight underneath soffit and center on seam.

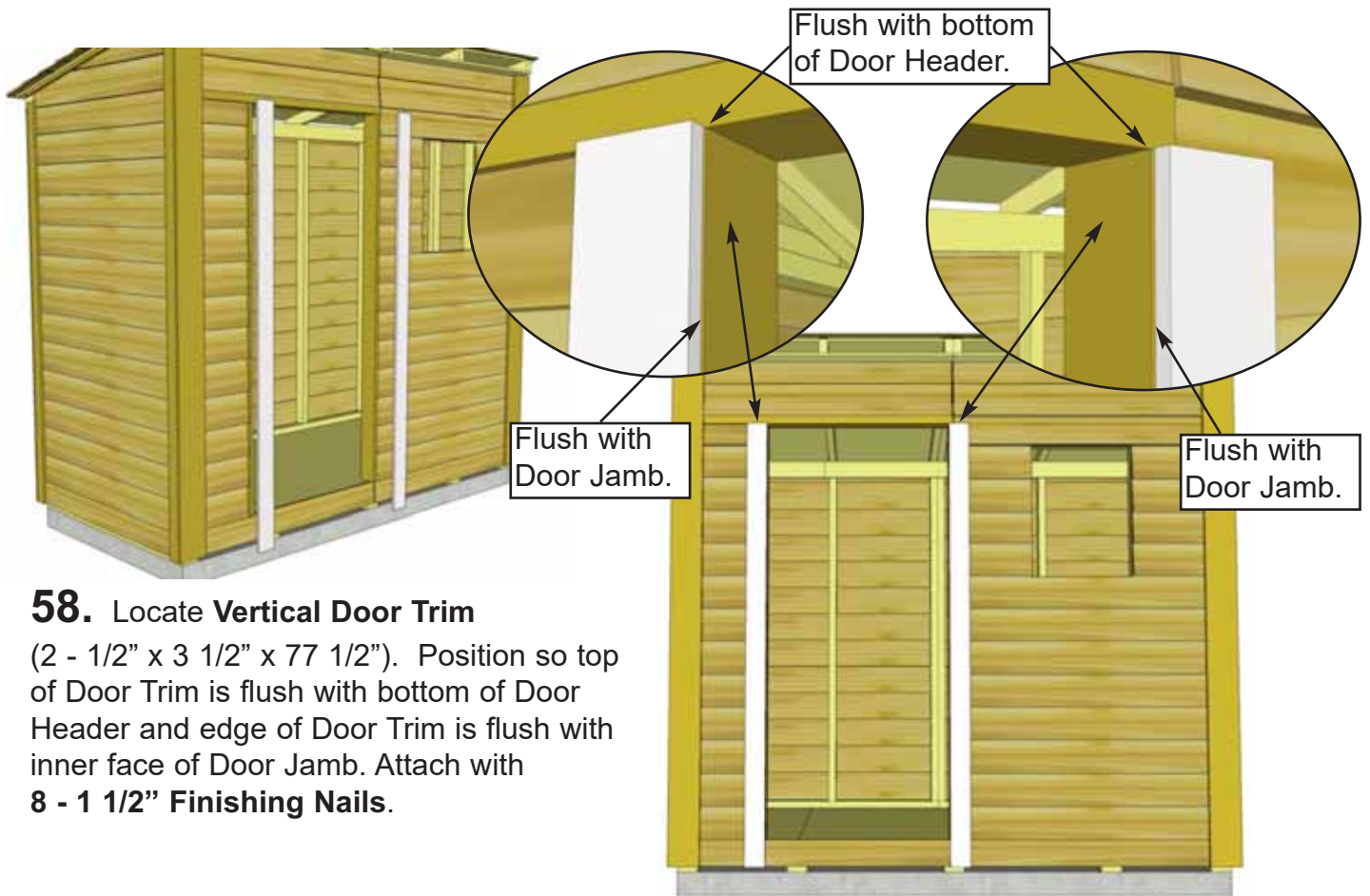

58. Locate **Vertical Door Trim** (2 - 1/2" x 3 1/2" x 77 1/2"). Position so top of Door Trim is flush with bottom of Door Header and edge of Door Trim is flush with inner face of Door Jamb. Attach with **8 - 1 1/2" Finishing Nails.**



59. Locate **Horizontal Door Trim** (1 - 1/2" x 2 1/2" x 46 3/4"). Position piece as shown and attach with **4 - 1 1/2" Finishing Nails.**



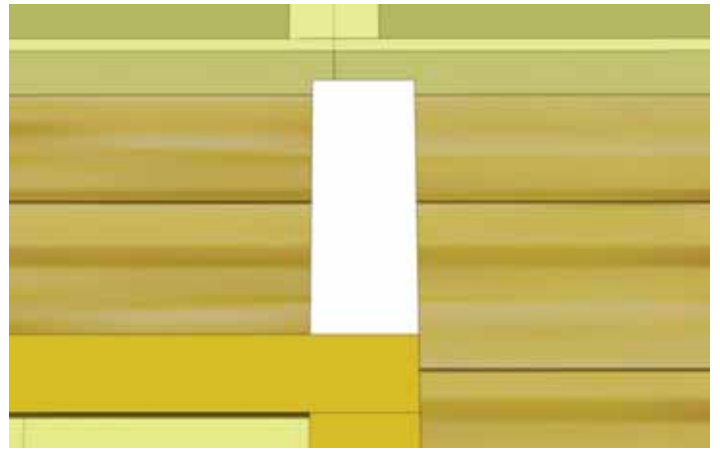

60. Locate **Front Middle Trim** (1 - 1/2" x 3 1/2" x 8 3/4"). Position tight against Horizontal Door Trim and in line with Vertical Door Trim. Attach with **2 - 1 1/2" Finishing Nails**.

Important - Drill Pilot Holes to prevent splitting.

Attach Hinges with 3/4" & 2" Black Screws.

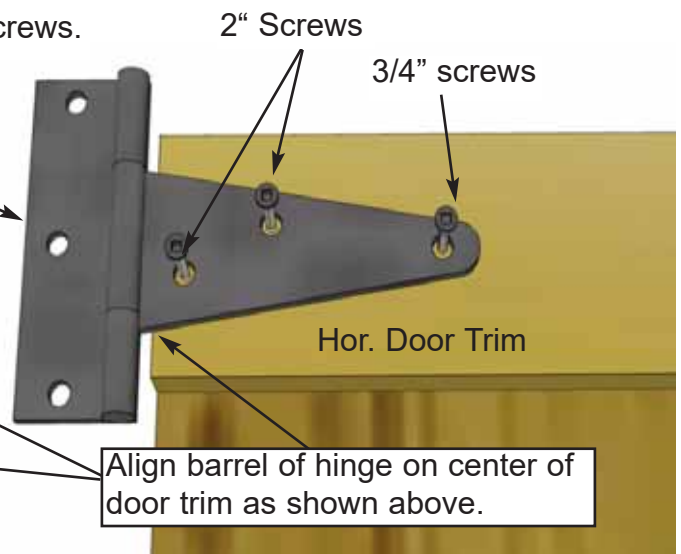
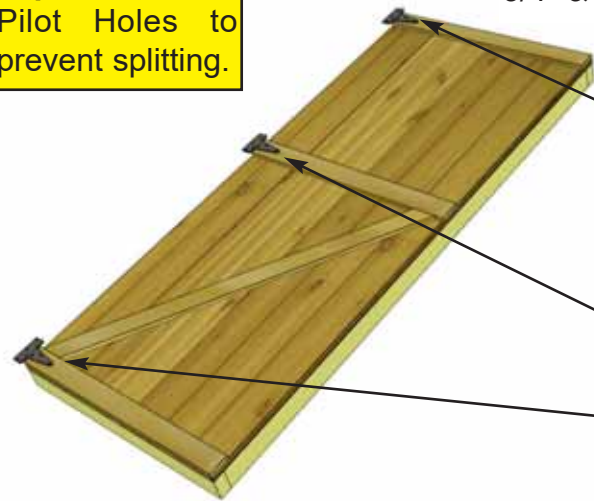

61. Attach Door Hinges to **Solid Door**. Position Hinges equally on door trim as shown above and attach with **Black 3/4"** and **2" Screws**.



Hint: Use Shim Shingle or extra piece of siding to help space Door at top and bottom.



62. With Hinges attached, position door in opening. You will need some assistance to hold door in place.

Important - Drill Pilot holes to prevent splitting.

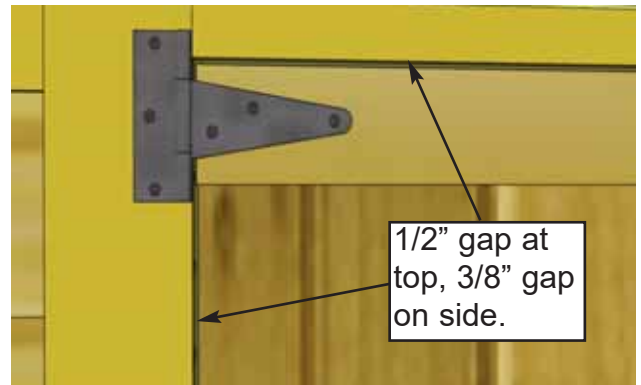
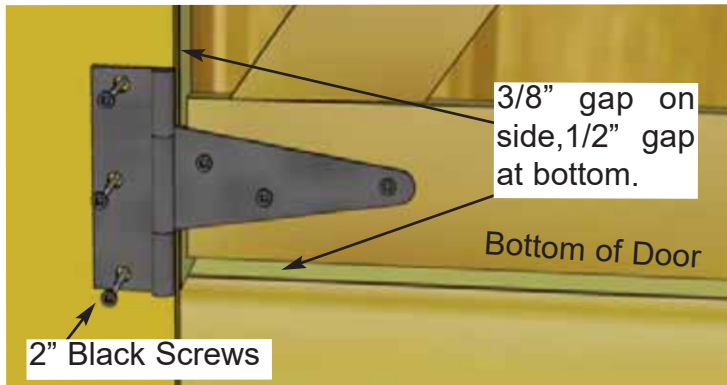

63. Once door is align in opening, position so there is a 1/2" gap on bottom, and approximately 3/8" on the side. Use a spare piece of siding or shingle to shim door in place at the bottom. Using **2" Black Screws**, secure bottom hinge to Door Trim. **Hint:** Do not attach all the 2" screws until the door is positioned correctly. You can use a Screw Driver to tighten screws completely so you don't over tighten.

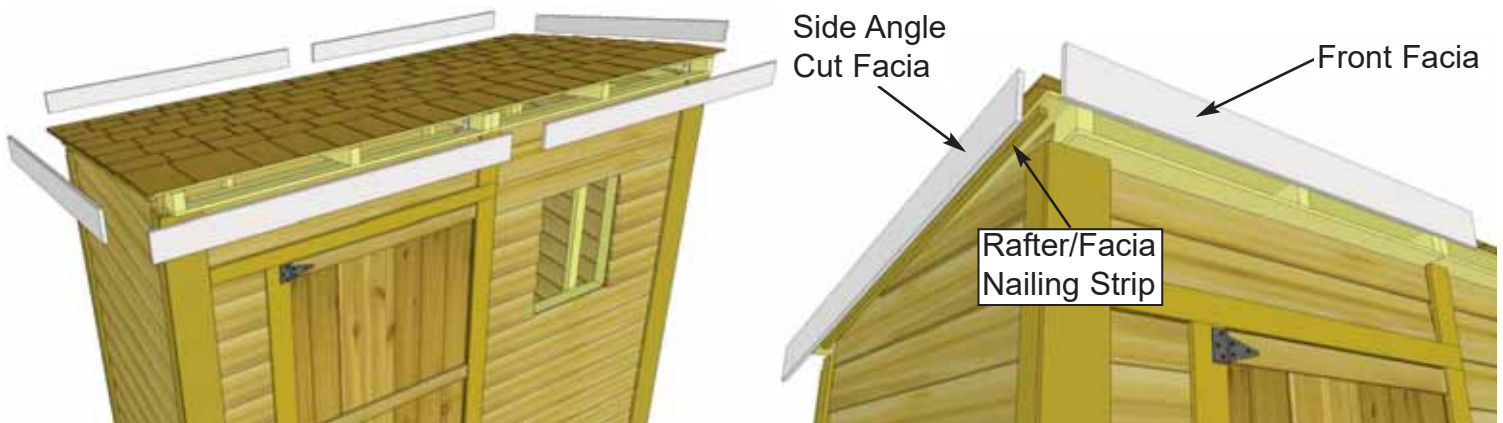

64. Locate and identify all Fascia pieces: **Front & Rear Fascia (4)** (1/2" x 4" x 50 1/2"). **Side Angle Cut Fascia (2)** (1/2" x 4" x 54 1/8"). In front corner, align side and front Fascia together. Front fascia will cap side fascia.



65. Do a dry run first before securing. Position Front Fascia up underneath roof panel and against rafter ends. Have your helper hold in position. Place angle cut Side Fascia underneath roof panel against Rafter/Facia Nailing Strip. Align so Front Fascia caps Side Fascia and then attach the front with **6 - 1 1/2" Finishing Nails**. Attach side with **5 - 1 1/2" Finishing Nails** securing them into the nailing plate (closer to the top of the side fascia board). Attach next piece of Front Fascia. **Note:** With Front Fascia correctly aligned at corners, a small gap may occur at center seam. This will be covered by Fascia Detail Plate in **Step 68**.

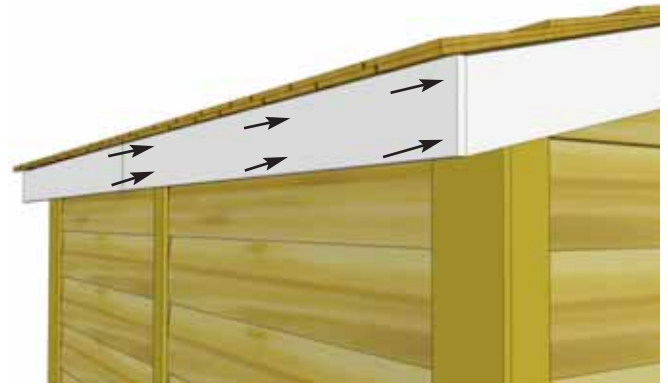
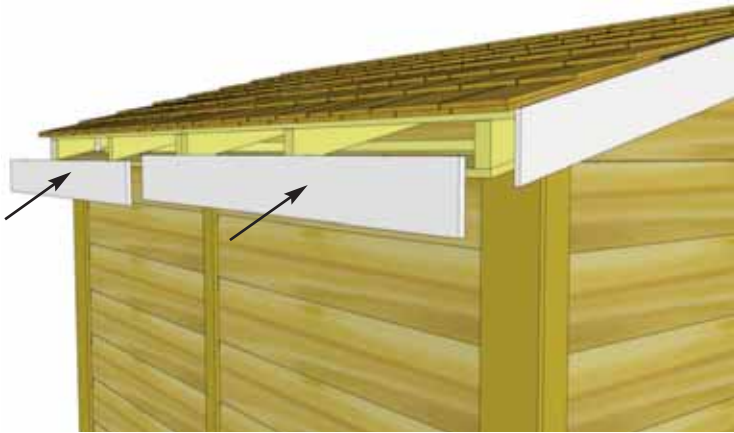

66. Place and align rear and side fascia for best possible fit with rear capping side fascia. Attach fascia to rafter ends with **6 - 1 1/2" Finishing Nails** per piece. Complete both rear fascia pieces.

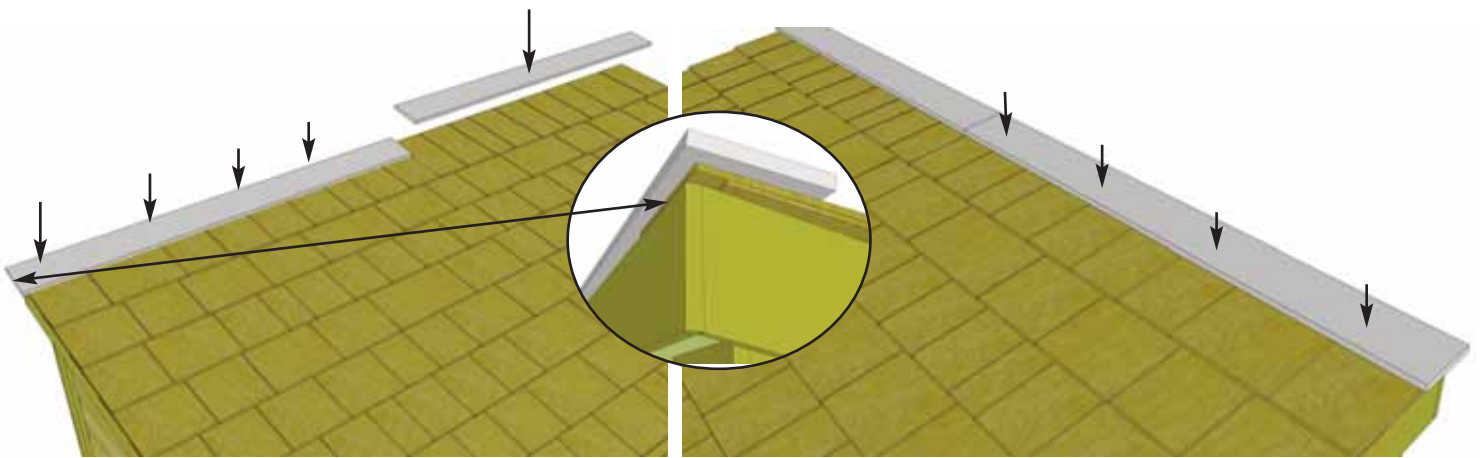

67. Position first **Roof Ridge Board** (1/2" x 4 1/2" x 51 5/8") at the front of roof to cap off shingles and fascia. Ridge Boards should meet on seam of roof panels. When aligned correctly, attach with **4 - 1 1/2" Finishing Nails** per piece.

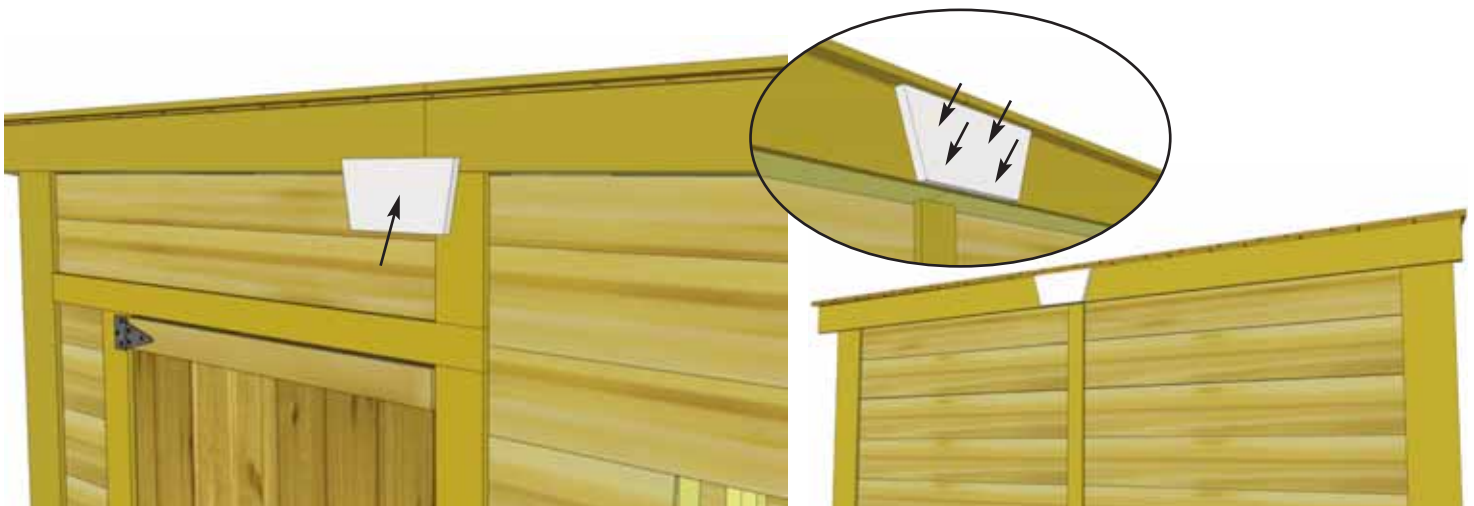

68. Attach **Fascia / Detail Plates** to cover seams where Front and Rear Fascia pieces come together. Secure with **4 - 1 1/2" Finishing Nails** per piece.



69. Attach Upper Interior Door Stop (1/2" x 1/2" x 32") positioning trim against door jamb and underneath door header flush to edges on inside as shown above. Attach with **4 - 1 1/2" Finishing Nails**.

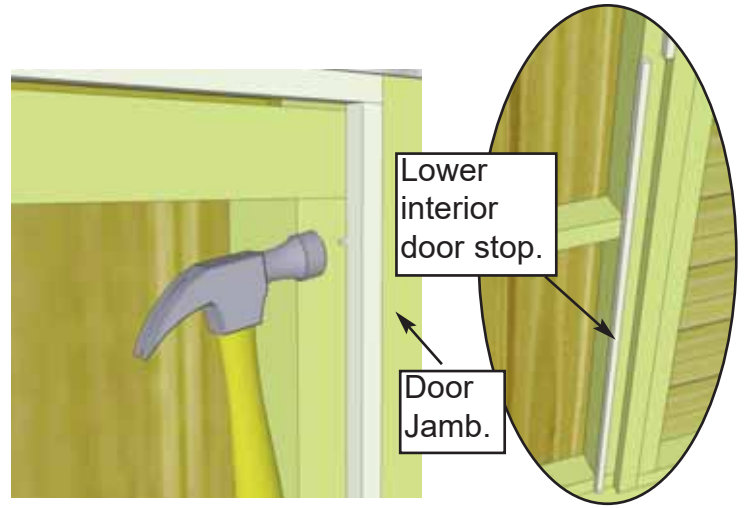

70. Attach upper and lower Vertical Interior Door Stops as per **Step 69**. Position against door jamb and underneath upper door trim. Attach with **4 - 1 1/2" Finishing Nails** per piece. Complete both sides.

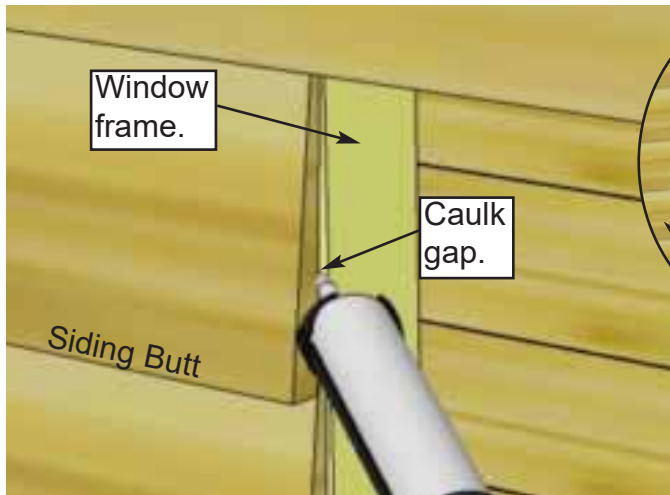

71. To reduce possible water from penetrating into the window cavity, caulk gap on both sides of window opening prior to installing **Window Insert**. Position insert in cavity and screw with **6 - 8 1 1/4" Screws**. On sides, make sure to screw insert into the thick butt of the siding only.

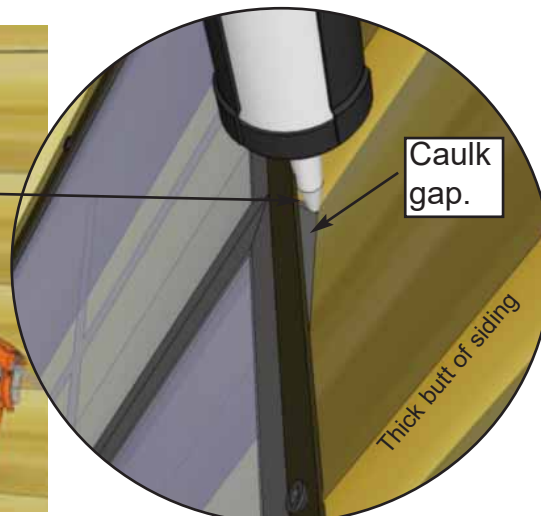
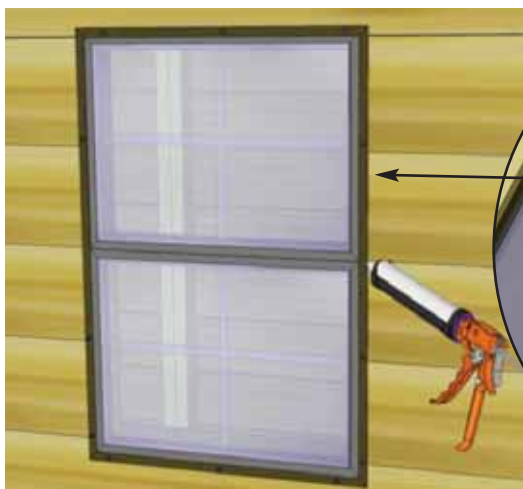

72. Once Insert is attached, caulk the "triangular gap" between the Insert's outside flange and the siding. Also put a bead of caulking horizontally at top of window where the flange and siding meet. This additional caulking will also reduce the chances of moisture entering into your shed.

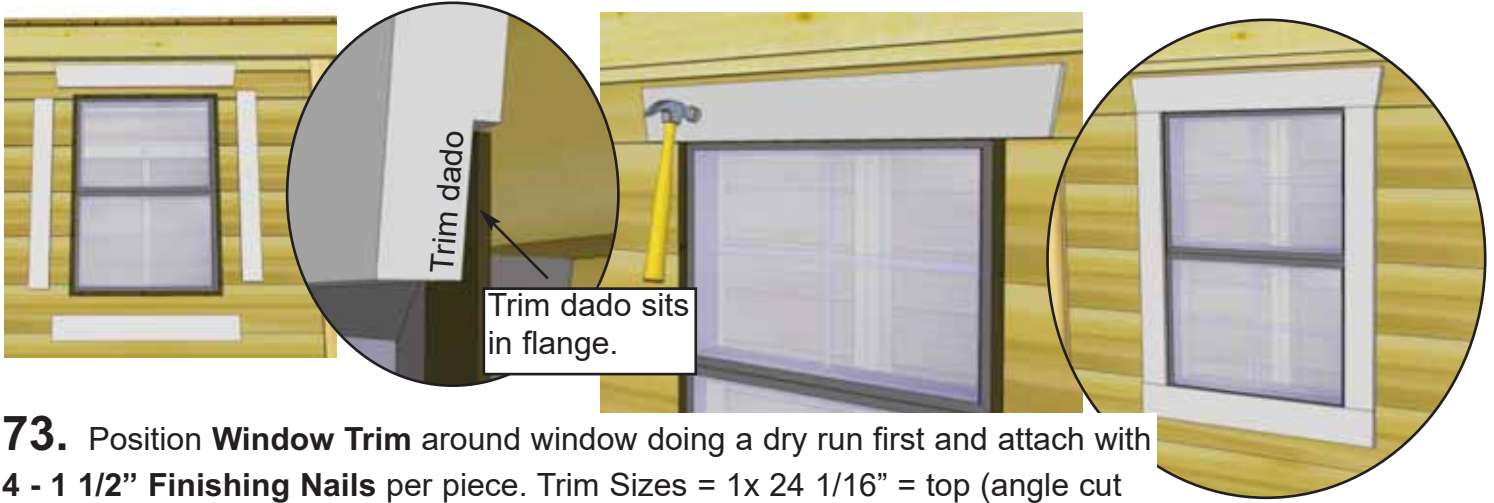

73. Position **Window Trim** around window doing a dry run first and attach with **4 - 1 1/2" Finishing Nails** per piece. Trim Sizes = 1x 24 1/16" = top (angle cut on ends) / 3 x 23" = Sides & Bottom. Window trim has a small dado on reverse face. Outside flange of window will roughly sit in the dado to give a better fit.



74. Assemble Flower Box with Assembly Instructions included with this Manual on Page 35. Center completed flower box below bottom of window trim and secure with **2 - 2 1/2" Screws**. Screw from inside of box into the center wall stud. Attach second screw 2" below first screw.



75. Attach **Door Handle**. Handle should be positioned with larger flange to top. Mount with **3/4" Black Headed Screws**.

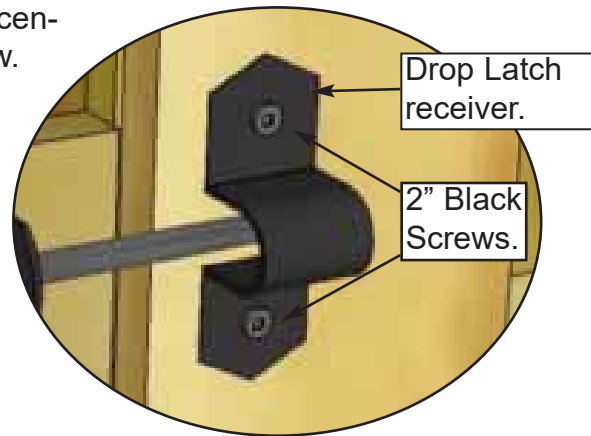
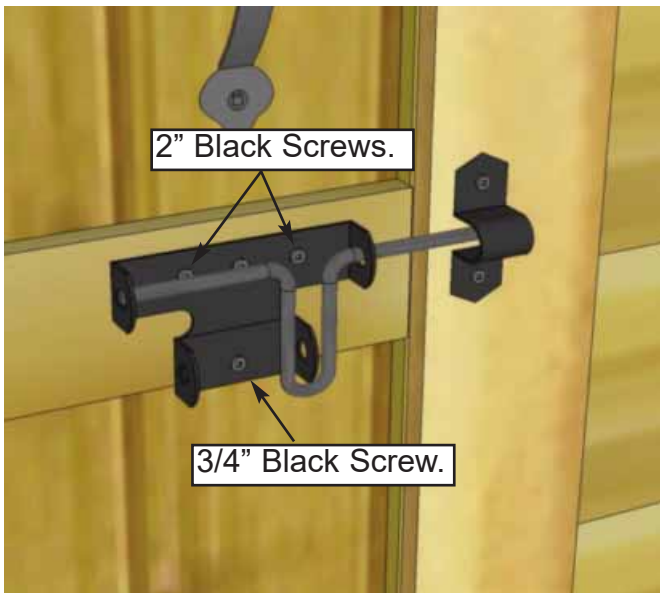

76. Attach Black Drop Latch as illustrated above with **2" & 3/4" Black Screws**. Note how Drop Latch receiver is positioned higher than male. Do a dry run first to position Drop Latch correctly. **Important** - Drill pilot holes with 1/8" drill bit prior to securing with screws to prevent wood splitting. Drill shallow pilot hole only since the screw is only 3/4" long.

Optional - Door Configuration on End Instructions. (New Door Jamb and Door Trim.)



77. Install Narrow Wall as per **Step 17.**

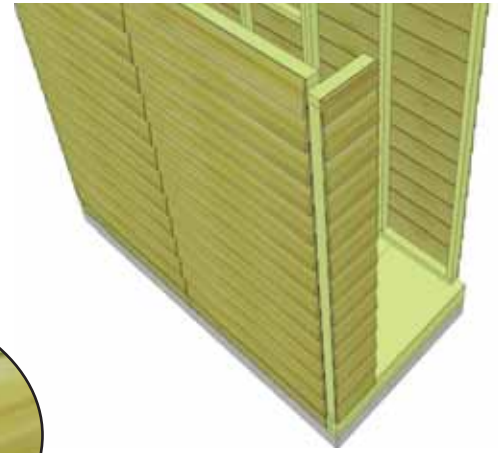

1 1/2" x 3 1/2" x 73"
Optional Door Jamb.

78. Position Optional Door Jamb as shown to the right and attach using **4 - 4" Screws** in the pre-drilled holes. Line up Jamb with outside of Side Wall Framing. Use Door Header (45 1/2" long) to align Jamb. Jamb will overhang floor at bottom.

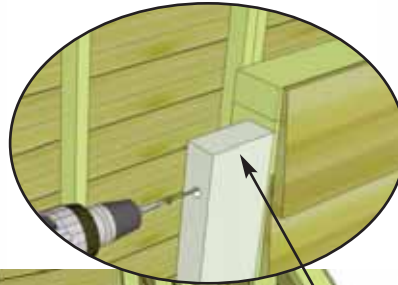

79. Attach Door Header as per **Step 21.**

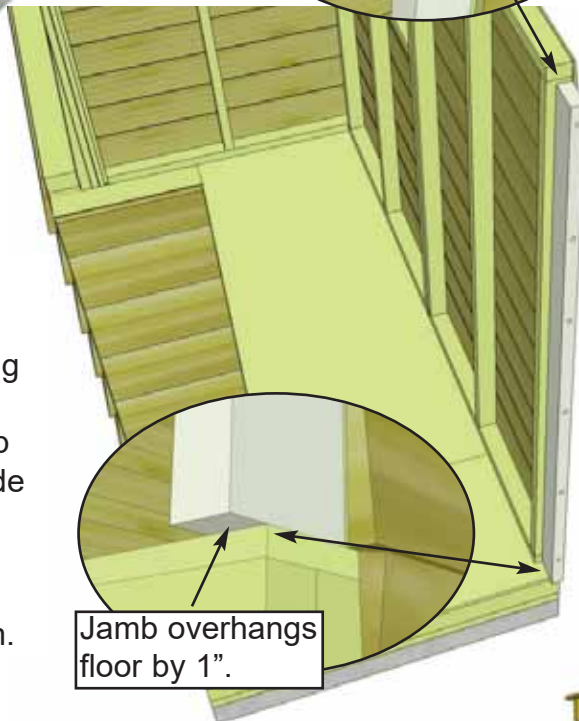

Jamb overhangs floor by 1".

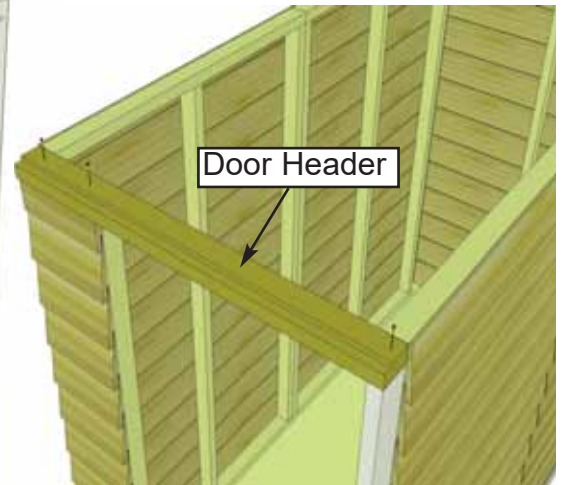

1/2" x 2 1/2" x 42 1/2"
Optional Hor. Door Trim.

Reg. Filler Trim.

1/2" x 2 1/2" x 88 3/4"
Optional Front Middle Trim.

Reg. Door Trim.

Reg. Corner Trim.



80. Install Reg. Door Trim and Hang Door as per **Step 58** and **Step 62.** Attach optional trim as shown. Trim corner as per regular steps.

Flower Box Assembly Instructions

Parts Lists:

A - Base, Rear & Front Box Frames	(3pcs)	3/4" x 5 1/2" x 23"
B - End Cap Frames	(2pcs)	3/4" x 5 1/2" x 7" / 8"
C - Front Trim	(1 pc)	3/4" x 1 1/2" x 26"
D - Side Trims	(2 pc)	3/4" x 1 1/2" x 8 3/4"
E - Brackets	(2 pc)	1 1/2" x 5 1/2" x 5 1/2"
F - 1 1/4" Screws		
G - 1 1/4" Nails		

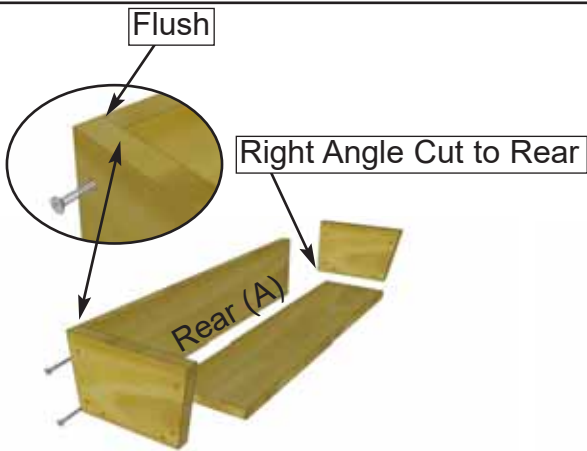
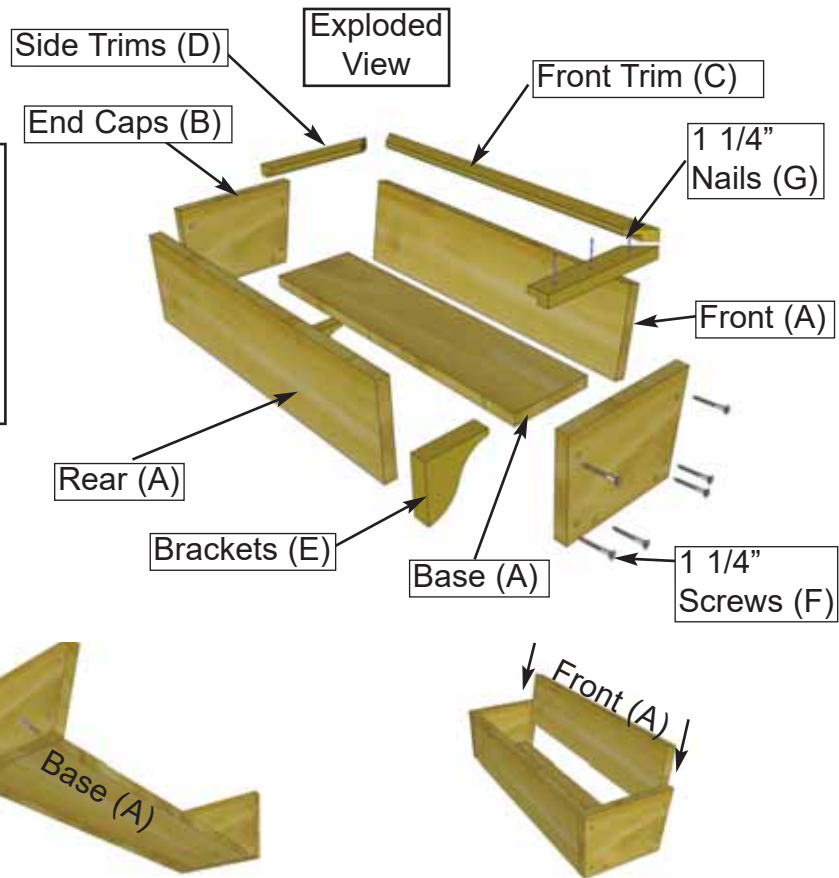

1. On a table position Rear Box and End Cap Frames together so flush at top. Fasten together with 2 - 1 1/4" screws. Place Base Frame tight against Rear and End Cap and flush at bottom. Secure with 2 - 1 1/4" screws. Complete attachment of remaining End Cap Frame. Slide Front Frame between End Caps.

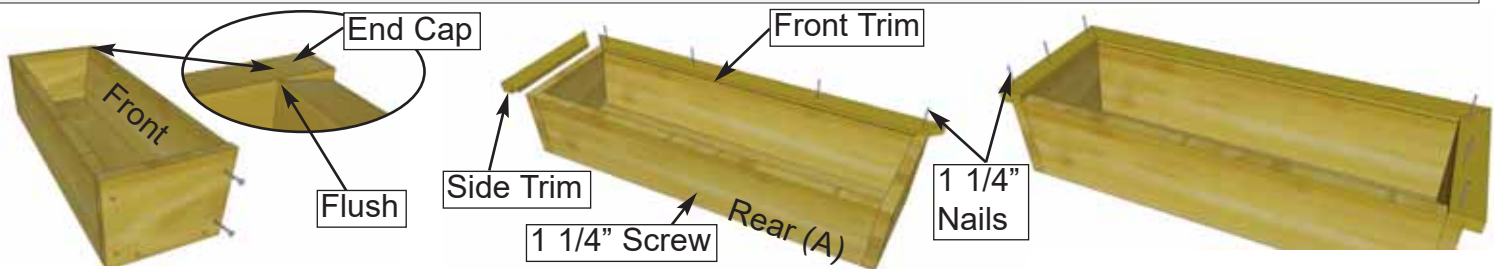

2. Position Front Frame Piece flush with End Cap. Attach both ends with 2 - 1 1/4" screws. Pilot hole Rear Box Frame near bottom center and secure to Base edge with 1 - 1 1/4" screw. Evenly position Front Trim (mitre cut on end and dado cut on inside bottom) tight against front frame and nail down with 4 - 1 1/4" nails. Position Side Trims as per Front and secure with 3 - 1 1/4" nails per side.

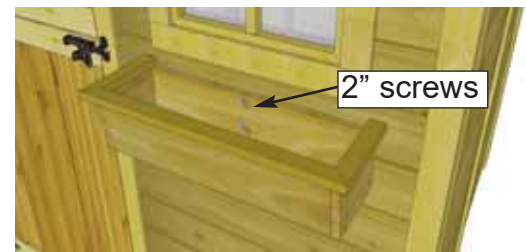
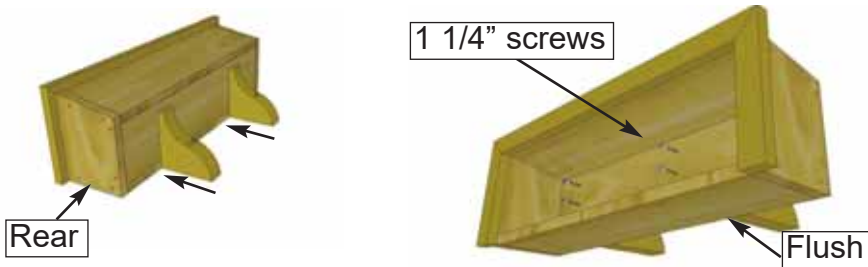

3. On a flat surface, flip Flower Box on it's rear face. Evenly space Brackets and secure through Base Frame and into the Brackets with 2 - 1 1/4" screws per Bracket. Position completed Flower Box beneath window trim and screw from inside of box into the center wall stud with 2 - 2" screws. (2" screws supplied with Base Kit.)

**Thanks for reviewing the
8x4 Garden Saver**
please email us with any and all questions

Made with North American Western Red Cedar

www.CedarShedAndGardenKits.com info@CedarShedAndGardenKits.com

Note: Our Sheds are shipped as unfinished products. If exposed to the elements, the western red cedar lumber will weather to a silvery-gray color. If you prefer to keep the cedar lumber looking closer to the original color, we suggest that you treat the wood with a good oil base wood stain. You may also wish to paint your new shed rather than stain it. In both cases we recommend that you consult with a paint and stain dealer in your area for their recommendations.



**Optional door
configuration**



We value your feedback and would like to hear back from you on how well we are doing in the following areas:

- 1. Customer Service**
- 2. On Time Shipping**
- 3. Motor Freight Delivery**
- 4. Quality of Materials**
- 5. Assembly Manual**
- 6. Overall Satisfaction.**

**Please email John and Pat Motley at
info@CedarShedAndGardenKits.com**

The materials contained in this Assembly Manual may be downloaded or copied provided that ALL copies retain the copyright and any other proprietary notices contained on the materials. No material may be modified, edited or taken out of context such that its use creates a false or misleading statement or impression as to the positions, statements or actions.