

Cedar

Shed & Garden Kits

8x4 GardenSaver with rear sloping **Cedar** **Shingle Roof and a** **Sliding Door** **ASSEMBLY MANUAL**

Made with North American Western Red Cedar

www.CedarShedAndGardenKits.com info@CedarShedAndGardenKits.com

**Thanks for your interest in
the 8x4 Garden Saver
Shed ~ John and Pat**

**Delivery is Free from the
Factory to your Home,
Ranch or Business and
Liftgate Delivery is always
included with every order.**

Please review this Assembly Manual and the Spec Sheet thoroughly before ordering. We want you to become familiar with all of the tools required and where and when assistants may be necessary. More than anything we want this to be fun and successful!



- Snow load ratings vary by geographical location. If heavy or wet snowfall occurs, it is advisable to sweep snow off roof frequently.
- If the product is elevated, any structural and building code requirements are solely the customer's responsibility, and should be abided by.
- In areas with high or gusty wind conditions, it is advisable to install the structure securely to the ground.
- Have a regular maintenance plan to ensure screws, doors, windows and parts are tightly affixed.

**Customer agrees to hold OLT Manufacturing and Cedar Shed And Garden Kits LLC,
Authorized Dealer, free of any liability for improper installation, maintenance and repair.**

In the event of missing or broken pieces, please call the Customer Support Line within 30 days of the delivery of your kit. You'll find the number in your Assembly Manual that comes with the kit. It is our commitment to you to deliver replacement parts, free of charge, within 10 business days of your notification. Replacement parts will not be provided free of charge after the 30 day grace period..

All structures purchased from OLToday are covered for a period of one year for defects in manufacturing and workmanship. Costs incurred for customer installations are not included.

Failure to use supplied parts included in this kit could result in poor product performance and may void your warranty.

What to do before my Shed arrives?



- Become familiar with this assembly manual and determine if you can complete the project yourself or will require a professional contractor.



- One helper is recommended to assist in constructing your shed. It generally takes two people two days to assemble a shed. If you're hiring a contractor, their rate should be in line with that duration of work.



- Clear the construction area and ensure a clear pathway for delivery when the freight company arrives. Remove all debris: roots, grass, rocks, etc.



- Excavate the site. Contact your local utilities company to ensure there are no gas or electric lines buried in the area before digging.

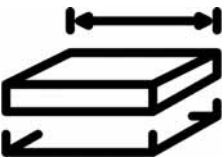

- Decide on the type of foundation you will be using:
 - Concrete slab, or
 - 4-6 inches of crushed gravel with paver stones or 4x4 stringers.

You can find the footprint for your shed on Page 3 of your Assembly Manual.

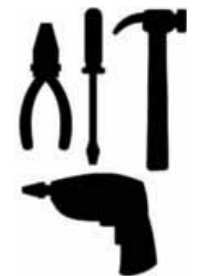

- If doing the assembly yourself, have all the necessary tools ready to go and in working condition. A list of required tools can be found after the parts list.

Foundation Types for 8x4 Garden Shed

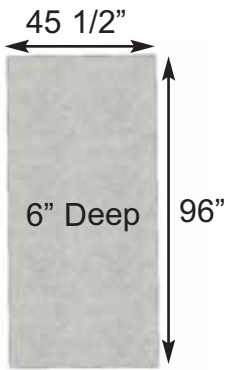

Concrete Foundation

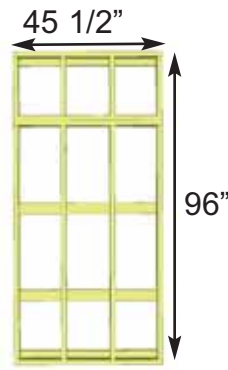

Floor Frame



Completed Foundation

Concrete Slab Foundation:

- Slab must be at least the same size as assembled floor frame (45 1/2" x 96") or larger.
- 6" Deep foundation.
- 0.6 Cubic Yards of concrete required.
- A concrete slab will have the longest durability out of your foundation options.

Once level, a concrete slab is the easiest surface to build on.

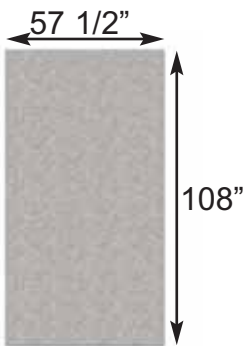

Gravel Foundation

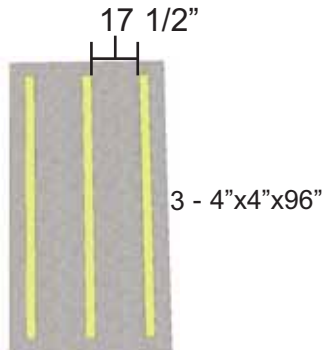

Gravel Foundation with treated stringers



Completed Foundation

Gravel with 4x4 Pressure Treated Stringers:

- Excavate at least 6" deep, and 6" wider than floor frame on each side.
- 1.0 Cubic Yards of gravel required, approximately 9 wheelbarrows.
- 3 - 4x4 Pressure Treated Stringers 8' long required.
- Evenly spaced, with one at each end of floor frame.

Saves money on materials, easy to level and work with.

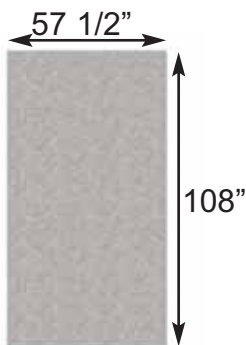

Gravel Foundation

15 Patio Stones



Gravel Foundation with Patio Pavers



Completed Foundation

Gravel with Patio Paver Stones:

- Excavate at least 6" deep, and 6" wider than floor frame on each side.
- 1.0 Cubic Yards of gravel required, approximately 9 wheelbarrows.
- 15 patio pavers (8" x 8" or larger).
- Center patio paver stones underneath floor runners and underneath seams in floor joists.

Patio paver stones are widely available from most landscape stores.

Parts List:

A. Floor Section

- 1 - 45 1/2" x 75" - **Large Floor Frame** (2 Joists unattached)
- 1 - 45 1/2" x 21" - **Small Floor Frame** (2 Joists ATTACHED)
- 2 - 1 1/2" x 3 1/2" x 71 7/8" - **Floor Joists**
(Steps 1 - 3)

- 2 - 1 1/2" x 3 1/2" x 45 1/2" - **Floor Runners Short**
- 3 - 1 1/2" x 3 1/2" x 47 3/4" - **Floor Runners Long**
(Steps 4 - 5)

- 1 - 5/8" x 45 1/2" x 75" - **Plywood Flooring**
- 1 - 5/8" x 45 1/2" x 21" - **Plywood Flooring**
(Steps 6 - 8)

B. Wall Section

- 5 - 1 1/2" x 2 1/2" x 45 1/2" - **Wall Plates**
- 4 - 45 1/2" x 75" - **Wall Panels**
- 1 - 45 1/2" x 73" - **Front Wall Panel**
(Steps 9 - 17)

- 1 - 2" x 3 1/2" x 68 1/4" - **Door Header - Long (Dado on edge)**
- 1 - 2" x 3 1/2" x 22 3/4" - **Door Header - Short (Dado on edge)**
- 1 - 1 1/2" x 3 1/2" x 73" - **Door Jamb - Vertical**
(Steps 18 - 19)

- 2 - **Top Triangular Siding Pc for Angle Wall Extenders (L/R)**
- 2 - 45 1/4" - **Angle Wall Extenders (L/R)**
- 2 - 9" x 45 1/2" - **Wall Extenders**
- 2 - 1 1/2" x 2 1/2" x 42 3/8" - **Extender Wall Cleats**
(Steps 20 - 27)

- 1 - 3/4" x 3 1/2" x 70" - **Horizontal Wall Cleat**
- 1 - 3/4" x 3 1/2" x 21" - **Horizontal Wall Cleat**
(Step 28)

C. Rafter & Roof Section

- 6 - 1 1/2" x 2 1/2" x 54" - **Rafters**
- 2 - 1/2" x 3 1/2" x 48" - **Front Soffits**
- 2 - 1/2" x 3 1/2" x 48" - **Rear Soffits**
(Steps 31 - 36)

- 2 - **Rafter/Facia Nailing Strips** - 3/4" x 3/4" x 51"
(Step 37)

- 2 - **Roof Panels** - 51" w x 56" d (1 - Left 1- Right)
(Steps 38 - 40)

- 4 - 5 1/2" Wide x 16" to 18" long - **Filler Shingles**
(Steps 41 - 44)

D. Miscellaneous Section

(Skirting, Trim, Door, Facia & Misc. Parts)

- 4 - 3/4" x 4 1/2" x 45 1/4" - **Bottom Skirting** (Bevel Siding)
- 2 - 1/2" x 4" x 45 1/4" - **Front Bottom Skirting** (non Bevel)
(Steps 47 - 49)

- 6 - 7/8" x 2 1/2" x 36" - **Corner Filler Trims**
- 2 - 3/4" x 2 1/2" x 36" - **Corner Filler Trims - Front Left** (Step 18)
- 2 - 3/4" x 2 1/2" x 10" - **Front Top Corner Filler Trims**
(Steps 18 & 29 & 50)

- 2 - 1/2" x 5 1/2" x 79" - **Rear Corner Trims**
- 2 - 1/2" x 5 1/2" x 88 3/4" - **Front Corner Trims**
- 2 - 1/2" x 2 1/2" x 80" - **Side Rear Corner Trims**
- 1 - 1/2" x 2 1/2" x 79" - **Rear Middle Trim**
- 2 - 1/2" x 2 1/2" x 88 3/4" - **Side Front Corner Trims**
(Steps 51 - 54)

Sliding Door Parts

- 1 - 49" x 74" - **Sliding Door**
- 1 - 71" long - **Aluminum Door Track with Hanging Brackets**
- 1 - 1 1/2" x 2 1/2" x 80 3/4" - **Lower Door Track**
- 1 - 3/4" x 4" x 87 3/4" - **Lower Door Track Cover**
- 2 - 1 1/2" x 3" x 3 1/2" - **Lower Door Track Stops**
- 1 - 1 1/2" x 3 1/2" x 87 3/4" - **Top Track Overlay**
- 1 - 3/4" x 5 1/2" x 87 3/4" - **Top Track Overlay - Front**
- 2 - 1/2" x 4 1/4" x 43 7/8" - **(Bevel Siding) - Track Overlay Sill**
- 1 - 1 1/2" x 2 1/2" x 66 7/8" - **Door Stop**
(Steps 55 - 64)

- 2 - 1/2" x 4" x 54 1/8" - **Side Facia** (Angle Cut Ends) - reverse
- 4 - 1/2" x 4" x 50 1/2" - **Front and Rear Facia**
(Steps 65 - 67)

- 2 - 1/2" x 4 1/2" x 51 5/8" - **Roof Ridge Boards**
(Step 68)

- 1 - 1/2" x 2 1/2" x 6 1/4" - **Front Middle Trim**
(Step 69)

- 2 - **Detail Facia Plates** (4" high)
(Step 70)

- 1 - 18" x 22 1/2" - **Window Insert**
- 1 - 24 1/16" angle cut / 3 -23" straight cut - **Window Trim Pkg**
(Step 71 - 72)

- 1 - 1 1/2" x 2 1/2" x 44" - **Interior Door Header**
(Step 74)

- 1 - 45 1/4" - **Extra Piece of Bevel Wall Siding** - Use if wall panel siding is damaged or to shim floor or door.

Note: All Trim, Facia and Bottom Skirting pieces will be positioned rough face out when installed.

8x4 GARDENSAVER WITH SLIDING DOOR HARDWARE PACKAGE

Hardware Kit (Provided)

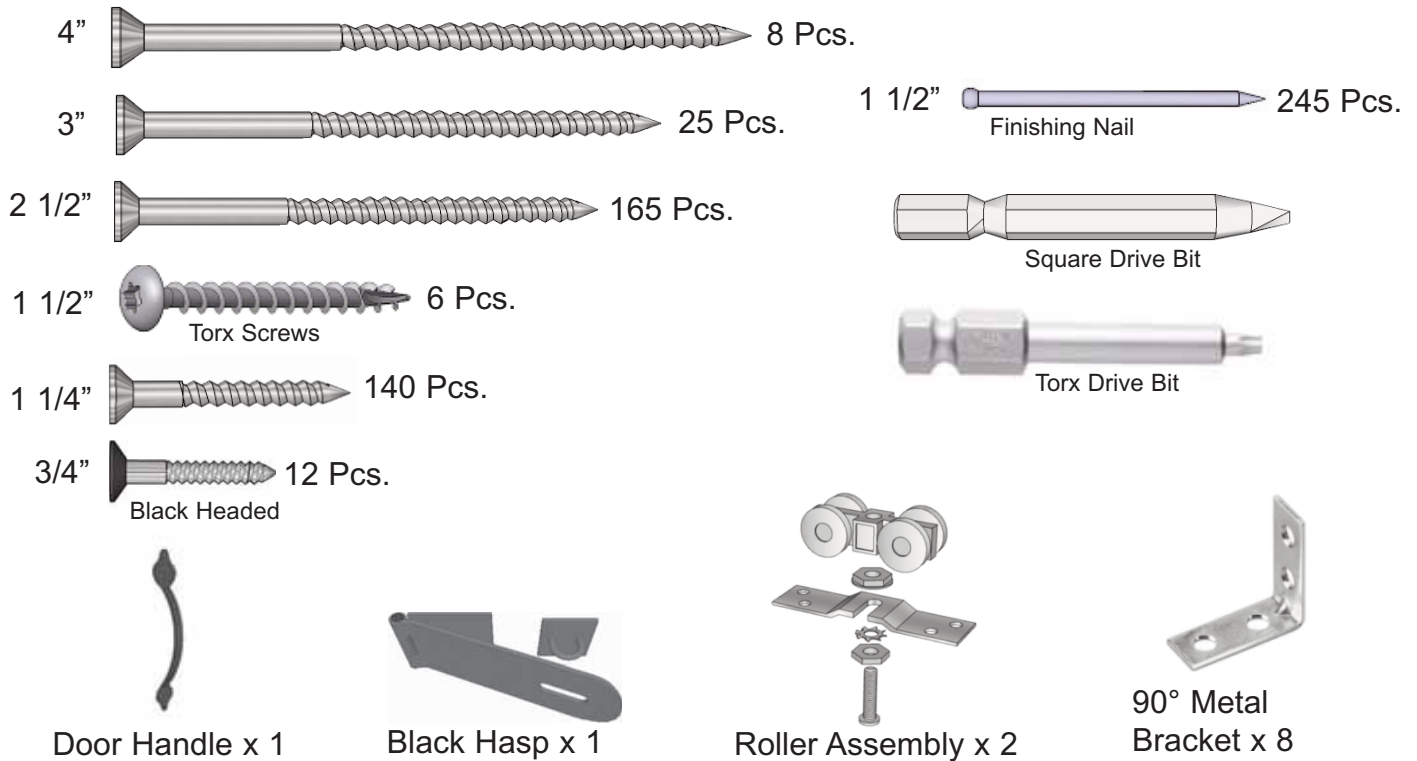

Tools Required (Not Provided)

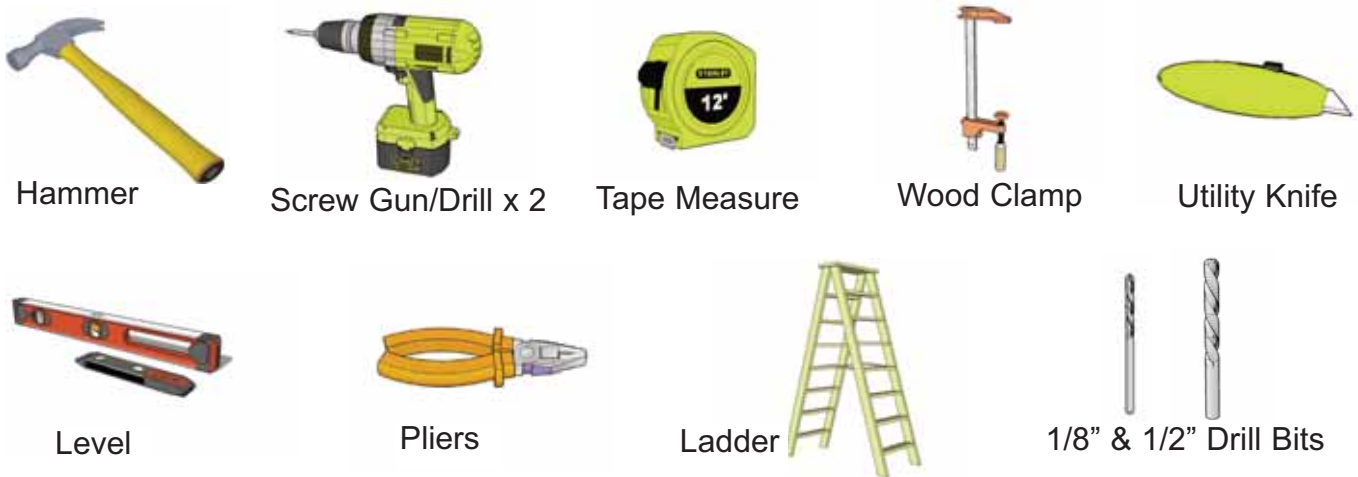

Safety Equipment Required (Not Provided)



Regular Maintenance & Tips to prolong the life of your shed.

Before/During Assembly:

- 1.) Paint each face and edge of your plywood floor with a latex exterior paint.
- 2.) Caulk wall seams if gaps appear.
- 3.) Caulk around window framing.
- 4.) Caulk perimeter between floor plywood and bottom wall plate.
- 5.) Caulk channels in lap siding at the top of your door above the trim, just a drop in each channel.
- 6.) Caulk edge of door threshold (if applicable).
- 7.) Optional: Install a Sill Gasket between floor runners and foundation.
- 8.) Optional: Install an 8" strip of roofing paper below Cedar Ridge Caps for Cedar Roof Sheds.

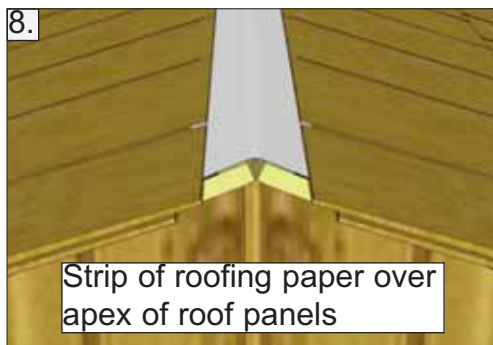
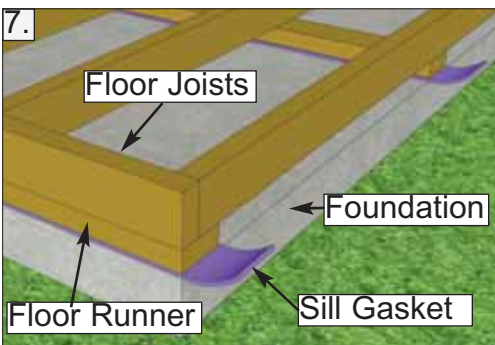
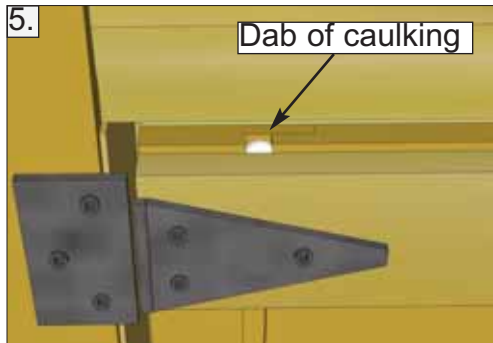
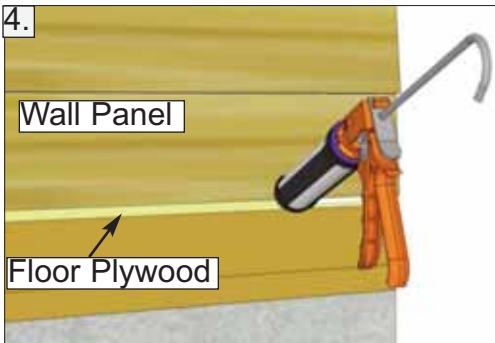
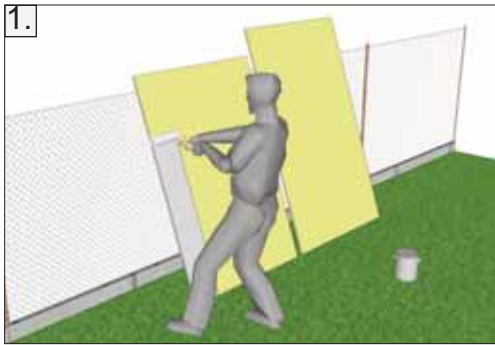

Routine Maintenance:

- Routinely check all fasteners are tight (ex. Door Hinges, Nails)
- Brush off dirt from walls.
- Brush off snow from roof regularly.
- Routinely remove needles and leaves from roof.

Painting/Staining

- Your cedar shed, if left untreated, will weather to a silvery grey colour.
- Painting or staining your structure is highly recommended and will prolong the life of your shed.
- You do not need to wait to paint or stain your shed, the wood in your kit has been dried and can be stained or painted immediately.
- Consult your local paint store for the best paint or stain for cedar.
- Optional: stain the inside of your shed. (Note: this will remove the fresh cedar smell.)

A. Floor Section

Exploded view of all parts necessary to complete Floor Section. Identify all parts prior to starting. Note: Floor Footprint is 96" wide x 45 1/2" deep.

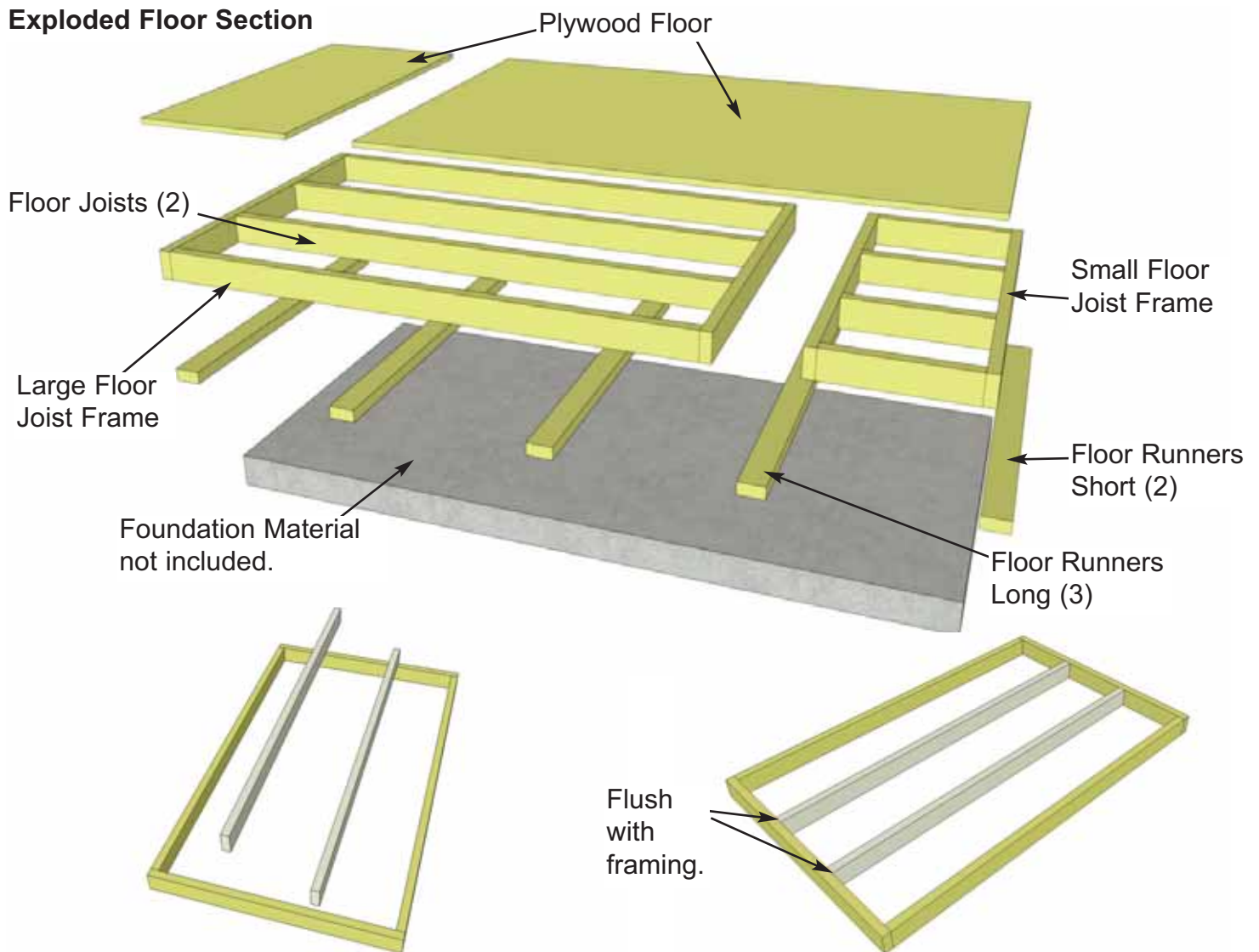

1. Lay out **Large Floor Joist Frame** and **2 Floor Joists** (1 1/2" x 3 1/2" x 71 7/8") as illustrated above. Position Joists equally in Floor Joist Frame. Use **Small Floor Joist Frame** as a template to determine joist position. Position Joist so flush with framing.

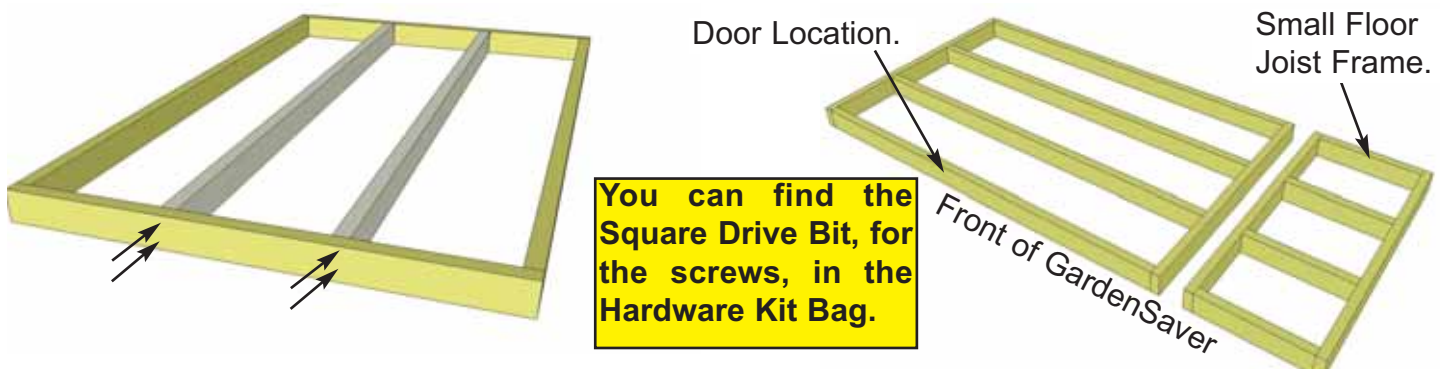

2. When correctly positioned, attach each Joist with **4 - 2 1/2" Screws (2 per end)**. You can find the Square Drive Bit for the screws in with the Hardware Kit Bag.

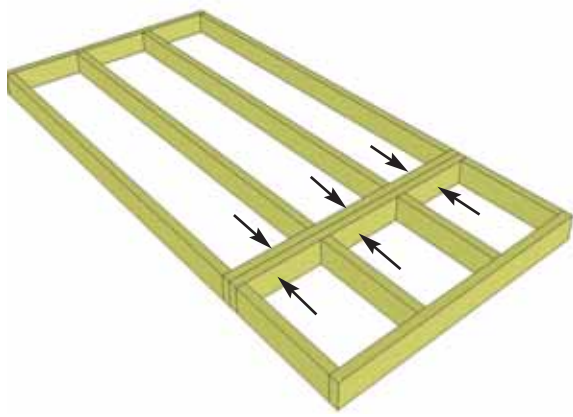

3. With Floor Joist Frames positioned together flush, attach with **6 - 2 1/2" Screws**.



4. Position and attach **Floor Runners Short** (1 1/2" x 3 1/2" x 45 1/2") on each side of the completed floor frame with **6 - 2 1/2" Screws** per Runner. Make sure Runners are flush with outside of floor framing but not overhanging.

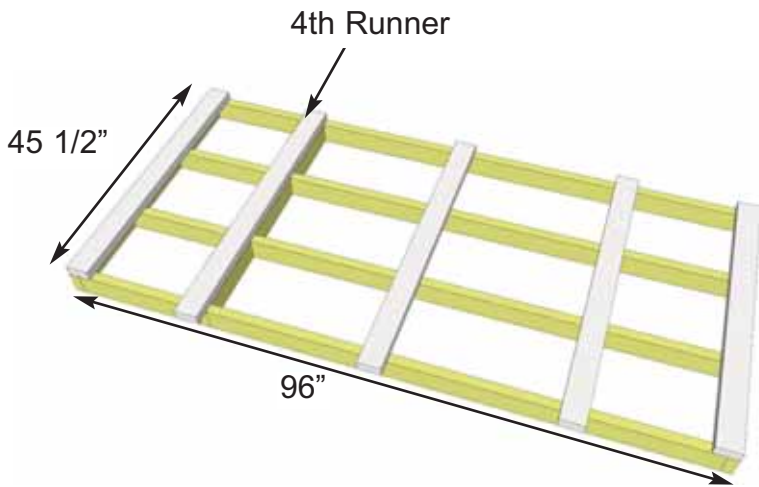

Floor Runners flush with Floor Frame on Back

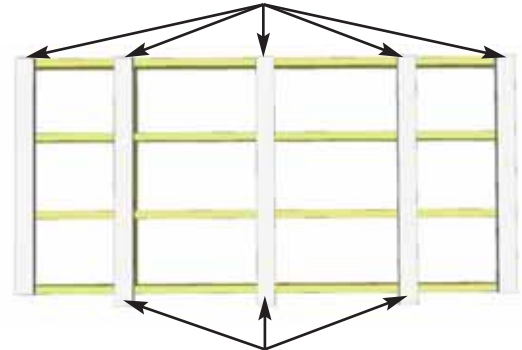

Long Floor Runners overhanging Floor Frame on front



5. Align **Floor Runners - Long** (1 1/2" x 3 1/2" x 47 3/4") evenly spaced as shown above and flush with the back of the Floor Frame. On the front, Runners will extend 2" past the Floor Frame to provide support for the Sliding Door Track later in the Assembly. Attach with **6 - 2 1/2" Screws** per Runner. Make sure 4th Runner is placed equally over seam where floor frames meet. With Floor Runners attached, carefully flip the floor over and place on your foundation. Caution - Be careful when laying floor down not to bend or twist floor. Note: Having a level foundation is critical. Choosing a foundation will vary between regions. Typical foundations can be concrete pads or patio stones positioned underneath the floor runners.

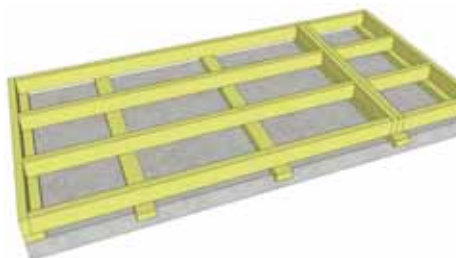

Important:
Floor should be completely level before moving to next step.

6. When in place, level floor completely before proceeding.

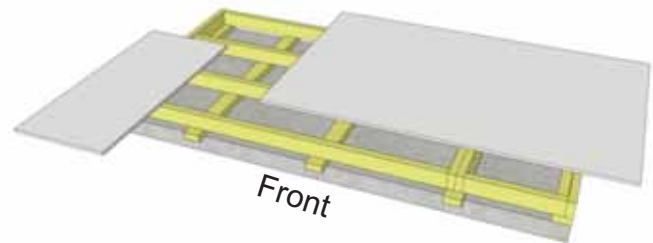

7. Position **Plywood Floor** pieces (2) on top of completed floor joists.

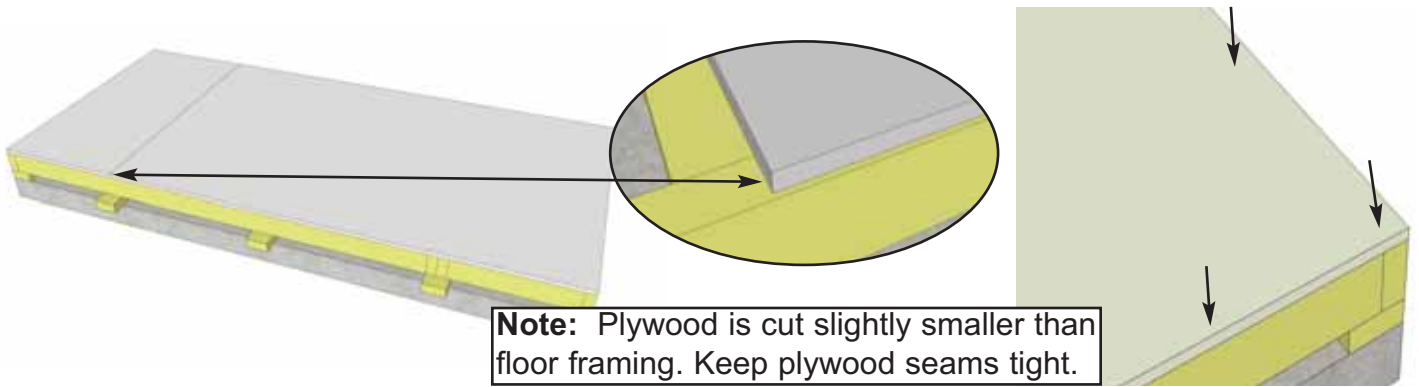

8. Position Plywood so it sits almost flush with outside of floor joist framing (see **Note**). When correctly positioned, attach to all floor joists with approximately **24 - 1 1/4" Screws**. Use screws every 16".

B. Wall Section

Exploded view of all parts necessary to complete the Wall Section. Identify all parts prior to starting.

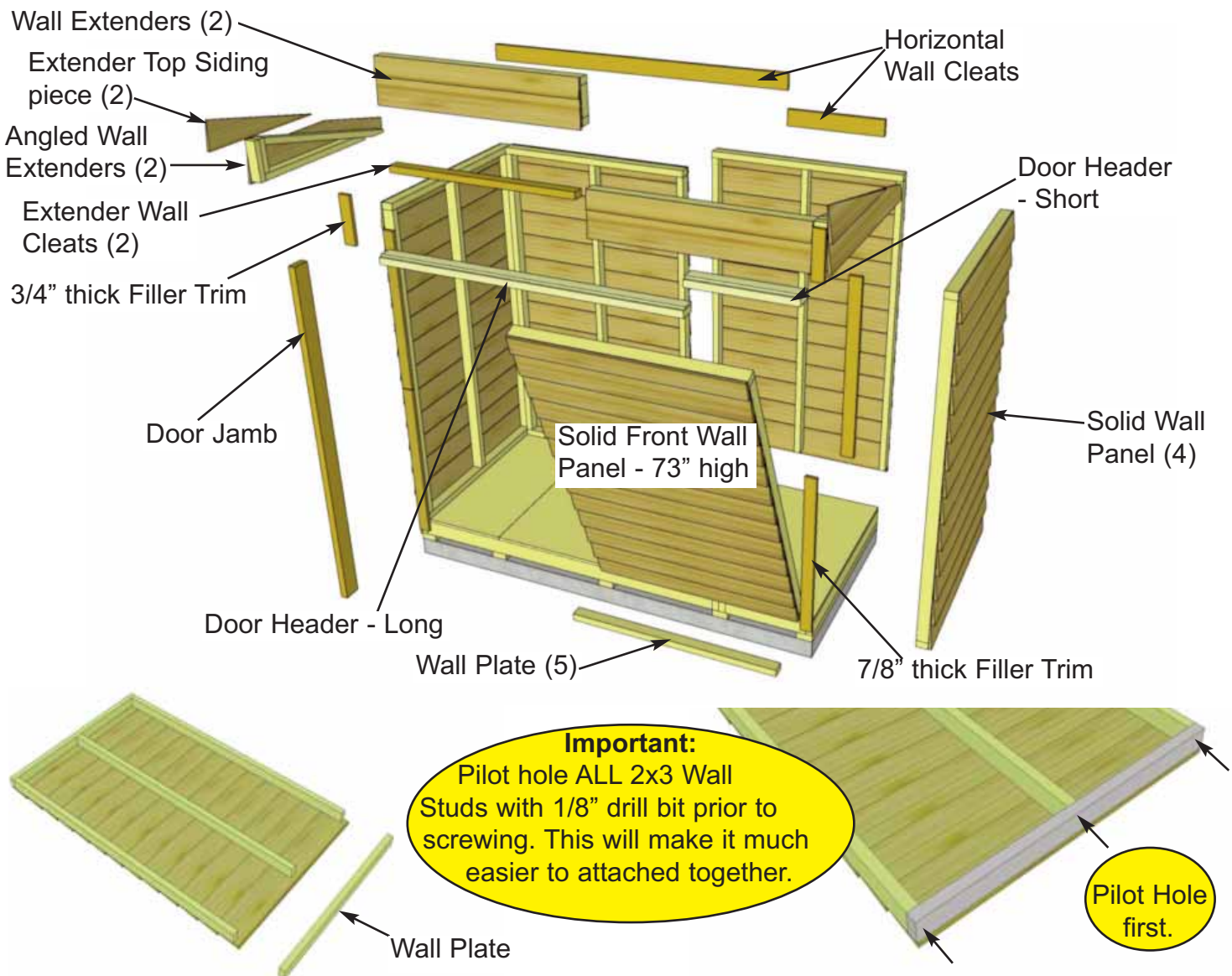

9. Locate 5 **Solid Wall Panels** and 5 **Wall Plates** (1 1/2" x 2 1/2" x 45 1/2"). Attach Plates to bottom of studs of each wall panel with **3 - 2 1/2" Screws**. Position so plates are flush with framing.

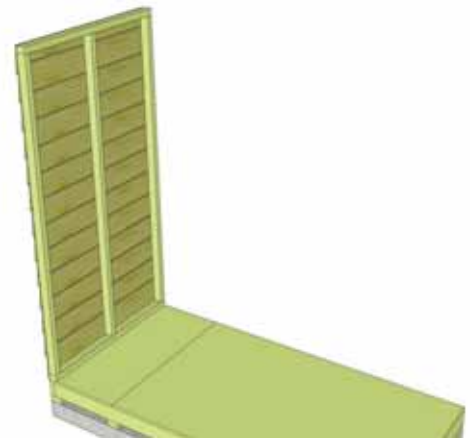

10. Starting on side, position a **Solid Wall Panel** on top of plywood floor. The Wall Panel bottom framing will sit flush with floor framing. Wall siding will overhang the floor. **Important:** Make sure all walls are aligned in their upright position. If not, water may leak into your shed. Unsure if panel is facing up or down? Recently attached Bottom Plate is on bottom of panel.

Do not align wall siding to floor. Align wall plate to outside of floor frame.

Wall Plate Flush with floor frame.

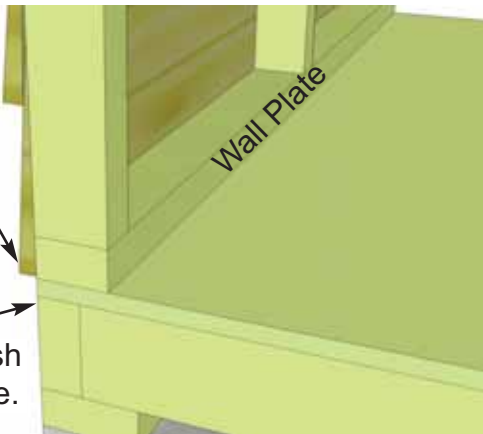

11. Outside 2x3 framing of wall panel should be flush with outside of floor framing when properly aligned. **Note:** Do not align wall siding to floor. Align wall plate to outside of plywood floor. When positioned correctly, locate 2nd Solid Wall Panel and place in corner.

Do Not Attach Walls To Floor until Step 30.

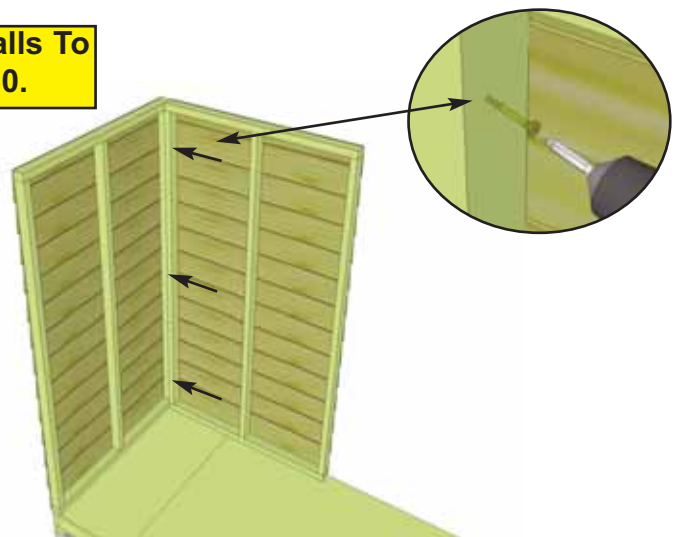
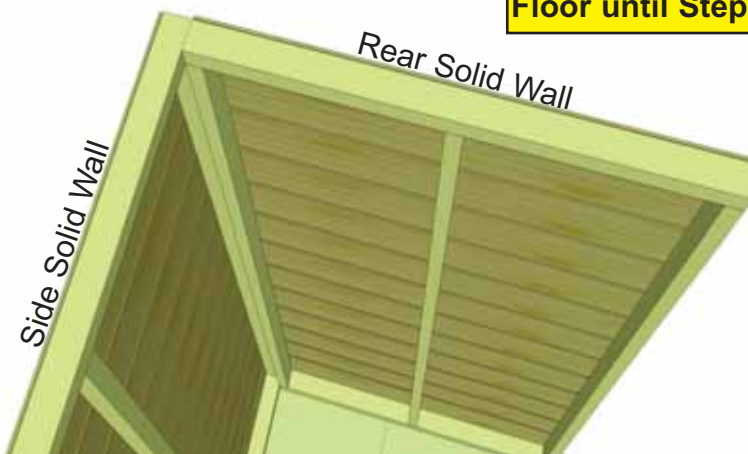

12. Butt both vertical wall studs of side and rear walls together and attach with **3 - 2 1/2" Screws**. Screw at the bottom, middle and top of stud to secure properly. Have helper push wall framing together while securing to ensure tight fit.



13. With the corner wall attachment complete, position the second rear wall panel in place so bottom 2x3 wall framing is sitting flush with outside floor framing. Wall siding should overhang floor by approximately 3/4". When positioned correctly, attach both wall panel studs together as per **Step 12** with **3 - 2 1/2"** Screws.

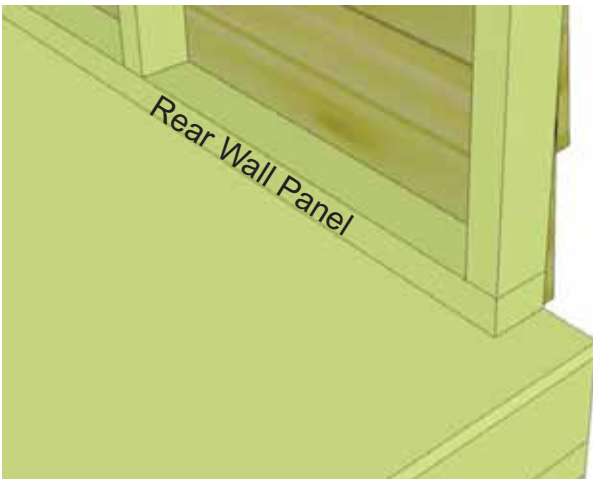

14. With Rear Wall Panel in place, position other side wall panel on floor as per **Step 10 & 11**.

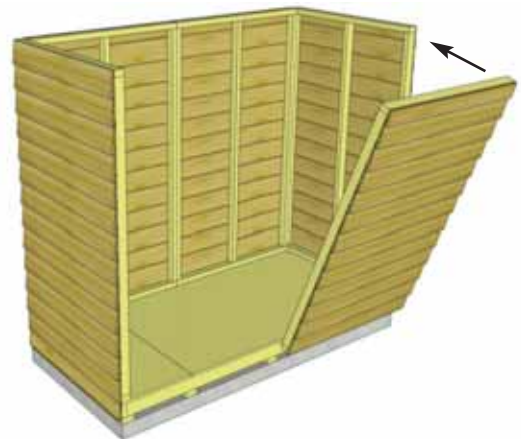

15. Secure side wall panel to rear wall panel as per **Step 12**. Next, locate the **Front Wall Panel** (73" high) and position in front right corner.

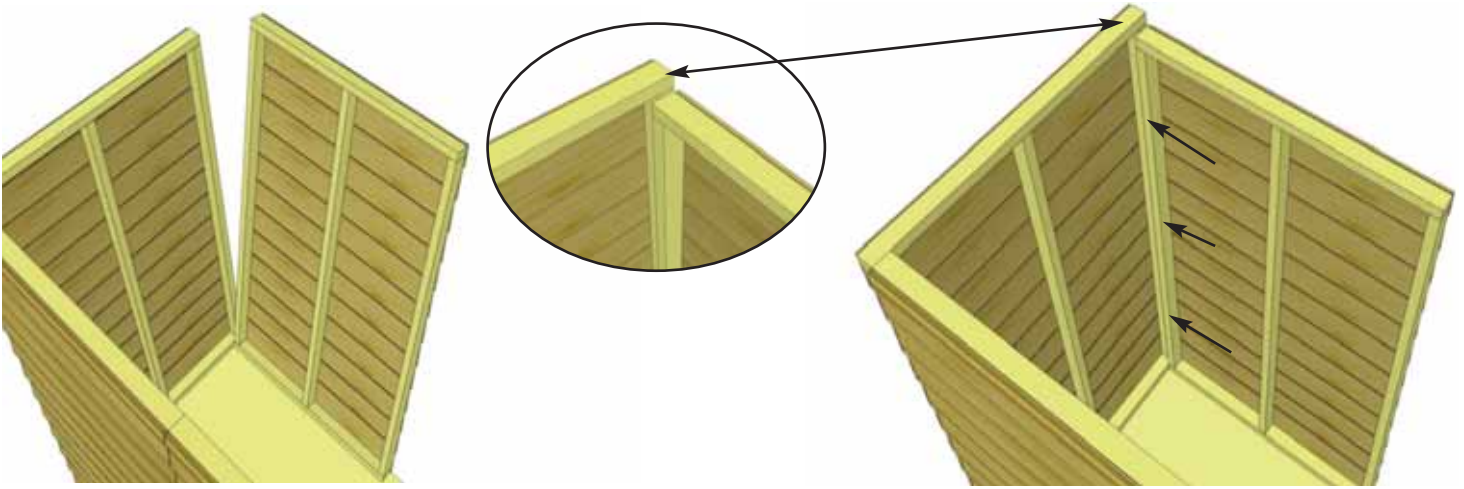

16. Once again position the 2x3 wall plate so it sits flush on floor and siding overhangs.
Note: Front Wall Panel is only 73" high.

17. When correctly positioned, secure Front Wall Stud to Side Wall Stud with **3 - 2 1/2" Screws**.

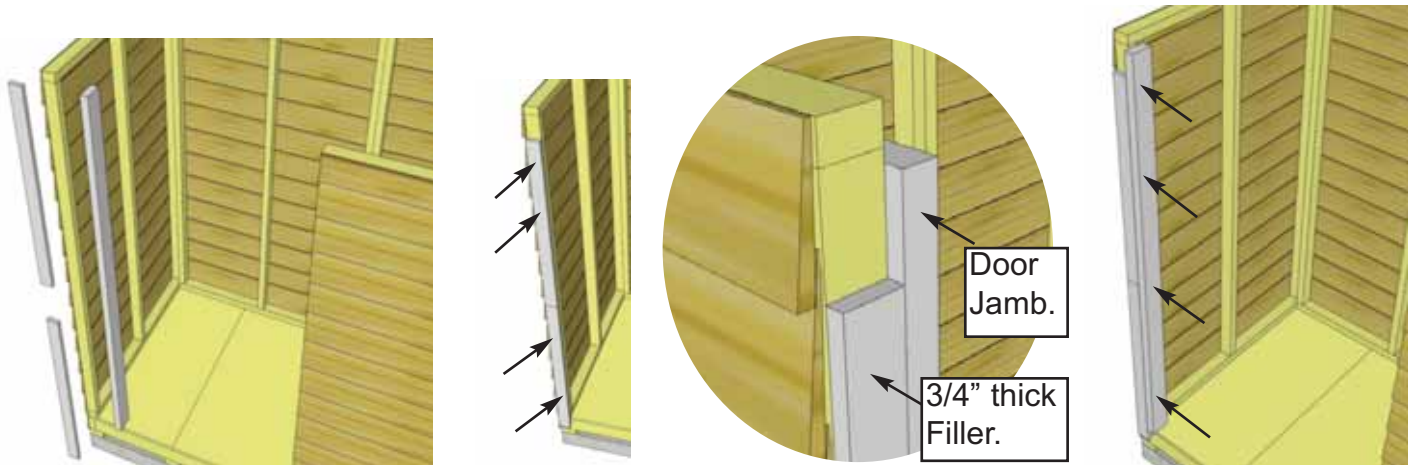

18. Locate **Front Left Corner Filler Trims** (2 @ 3/4" x 2 1/2" x 36") and **Door Jamb** (1 1/2" x 3 1/2" x 73"). Attach both Fillers with **4 - 1 1/2" Finishing Nails** as shown above. Place Door Jamb against inside wall stud and align with edge of filler. Attach Jamb with **4 - 2 1/2" Screws**.

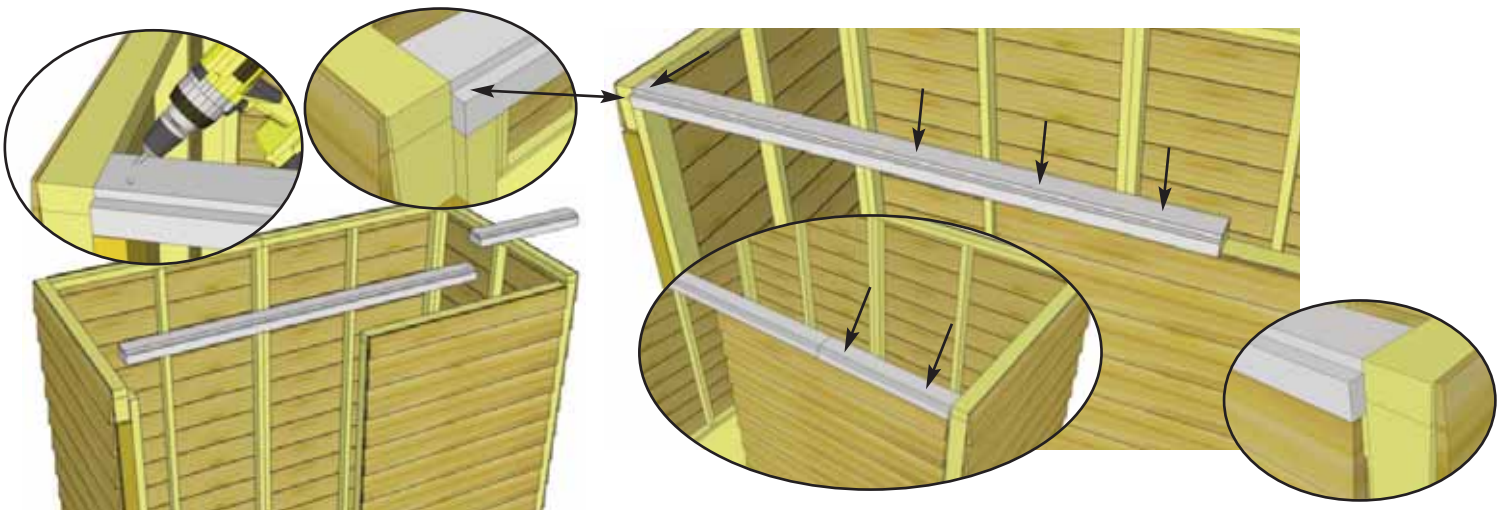

19. Locate both **Door Headers - Long and Short** (step facing up and out). Attach long header using **5 - 2 1/2" Screws**. Pre-drill left side and angle screw down. Line up header/filler/wall stud as shown above. Position and attach short header using **2 - 2 1/2" Screws** as shown above.

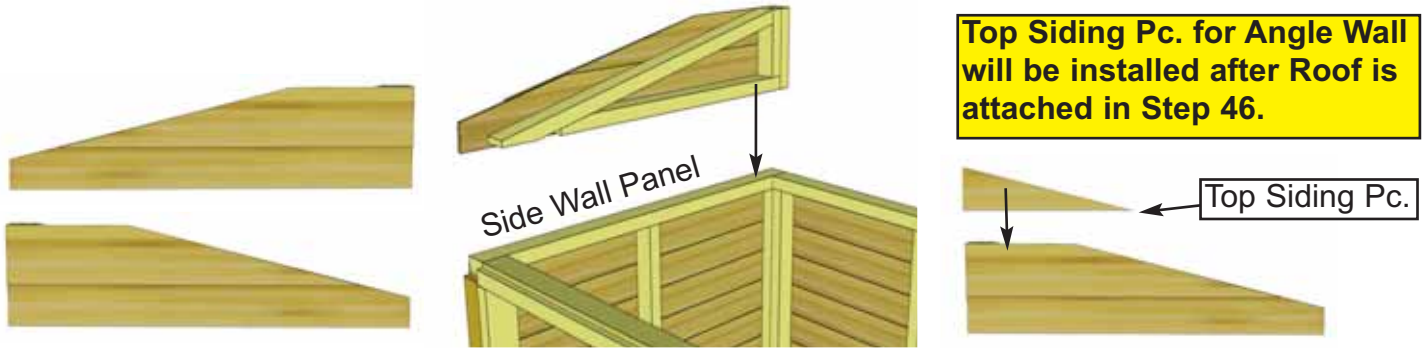

20. Locate both **Angled Wall Extenders (L/R)**. Place first wall extender on side wall panel frame.
Note: Bottom siding of wall extender will overhang and cover siding of side wall.

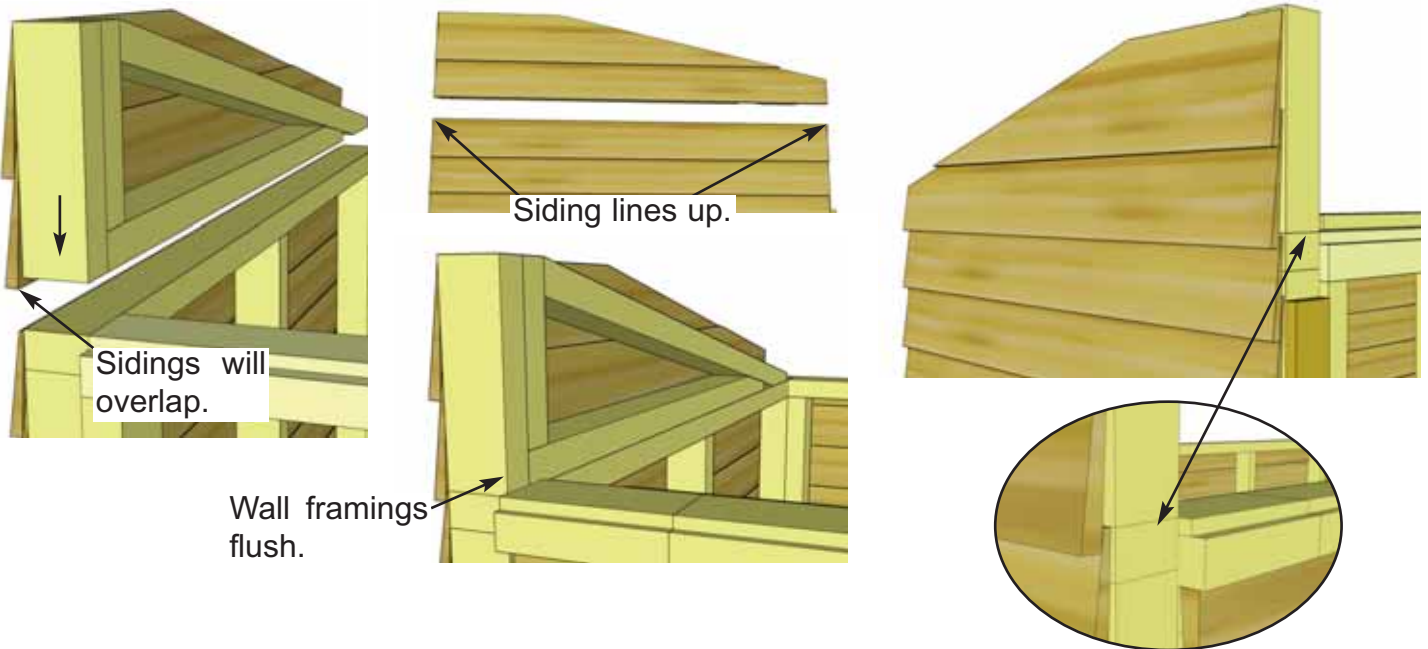

21. Align wall framing of Angled Wall Extender and Side Wall so they are flush at the front. The siding for both walls should also align evenly from front to back.

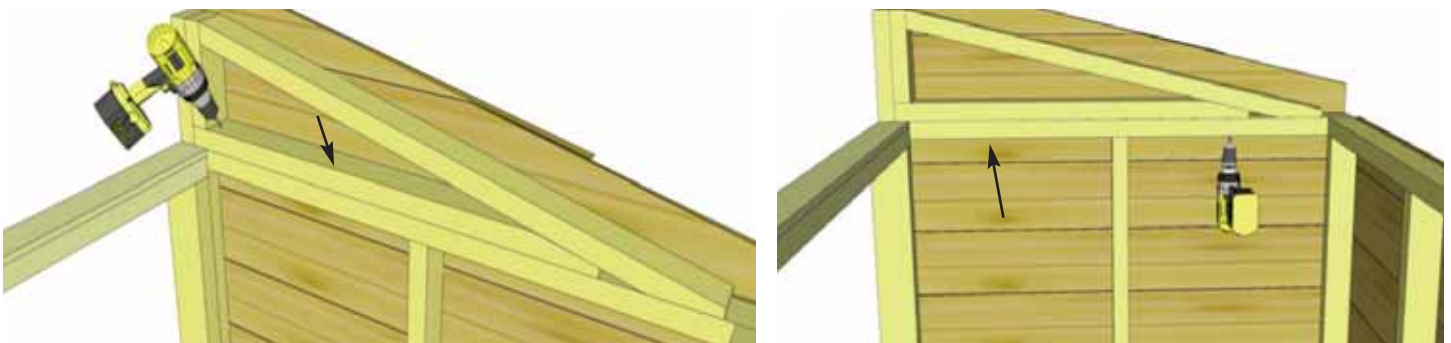

22. With Angled Wall Extender and Side Wall aligned correctly, secure together from the inside with **4 - 2 1/2" Screws**.

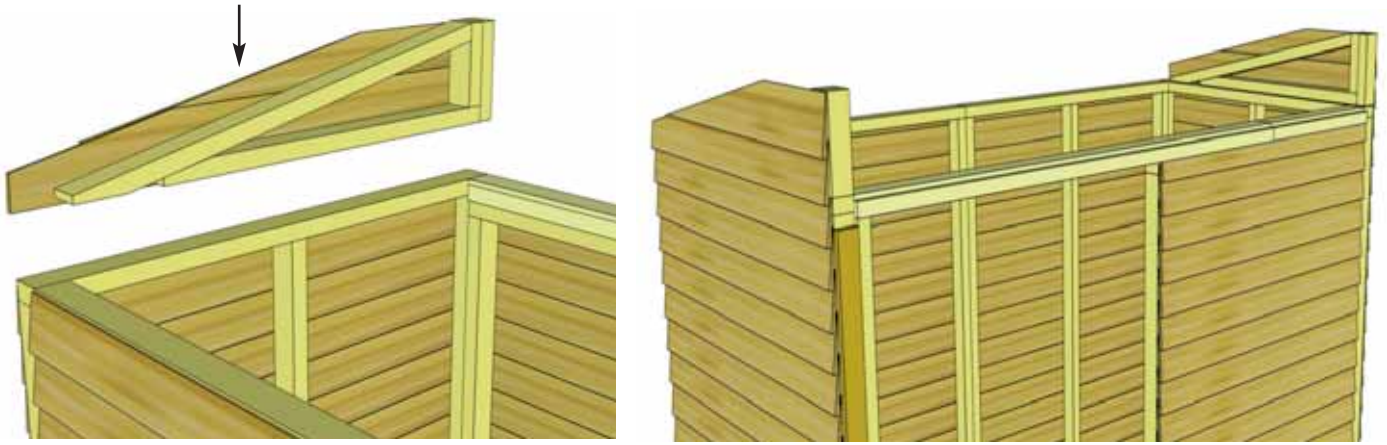

23. Complete opposite Angled Wall Extender positioning and attachment as per **Steps 21 & 22.**

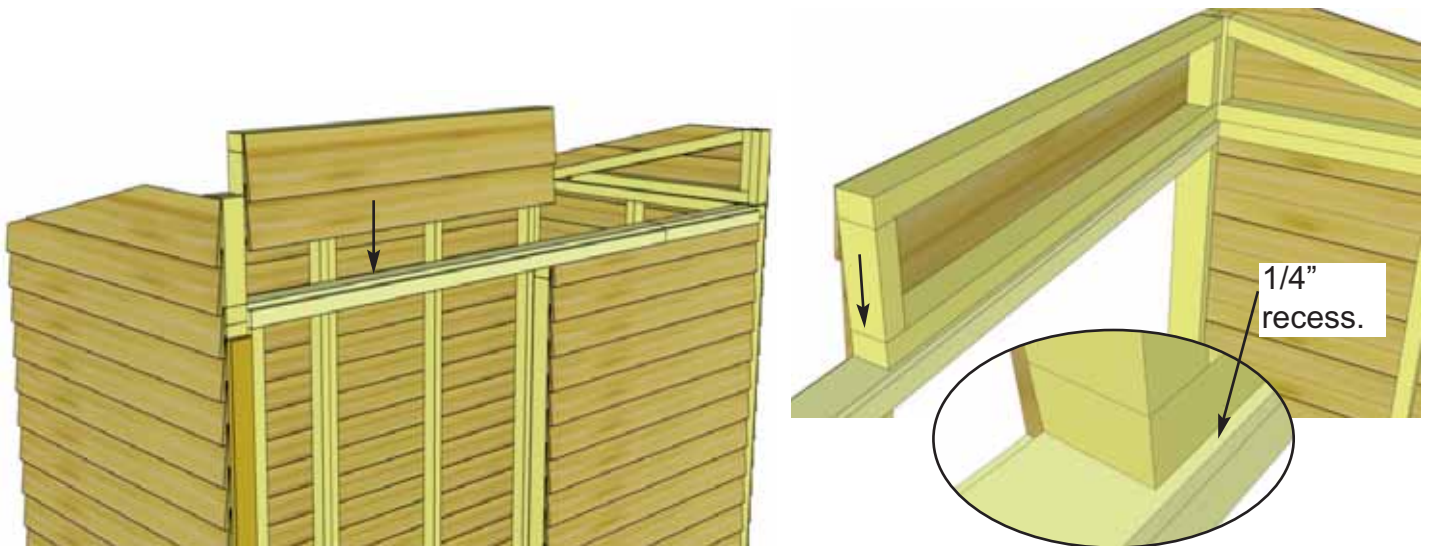

24. Locate one **Wall Extender** and place on Door Header with extender framing flush with inside edge of Header. Overhanging siding on front of extender will rest in notch of Header.

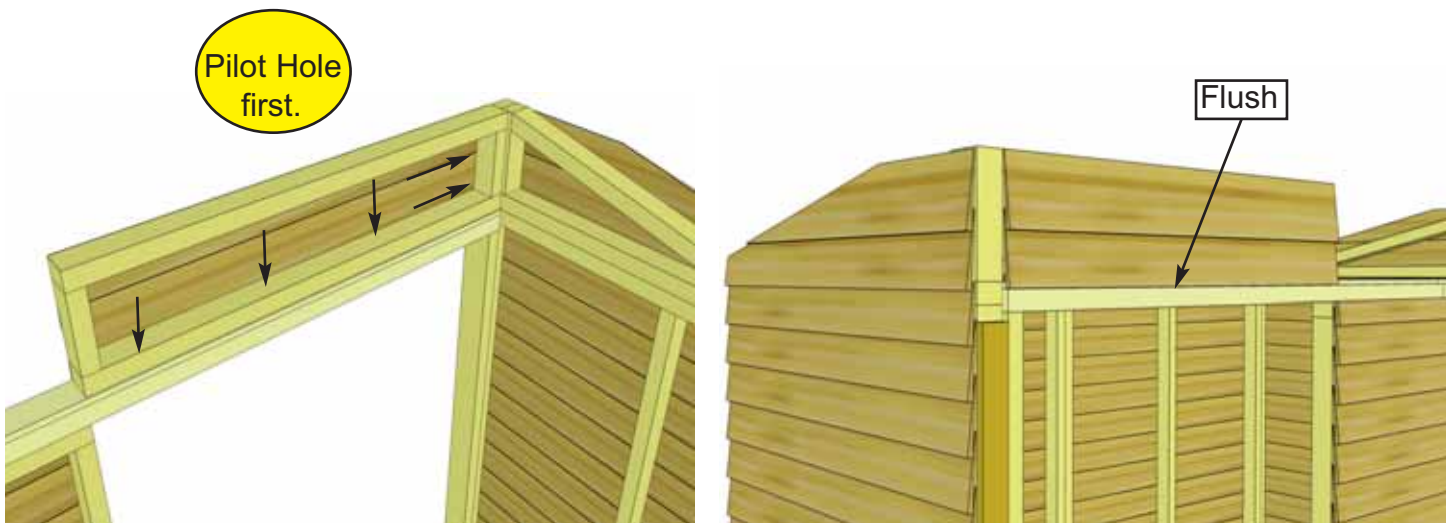

25. Attach Wall Extender to both the Angled Wall Extender framing and the Door Header with **5 - 2 1/2" Screws.**

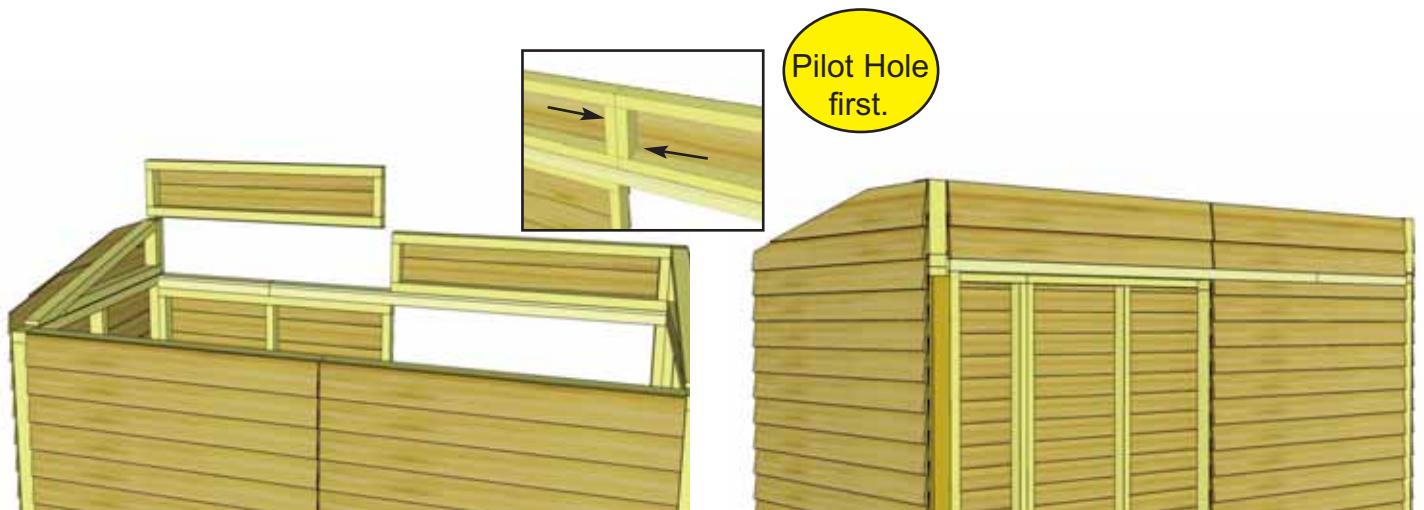

26. Position and secure 2nd Wall Extender Panel as per **Steps 24 & 25**. Additionally, attach to first Extender with **2 - 2 1/2" Screws**.

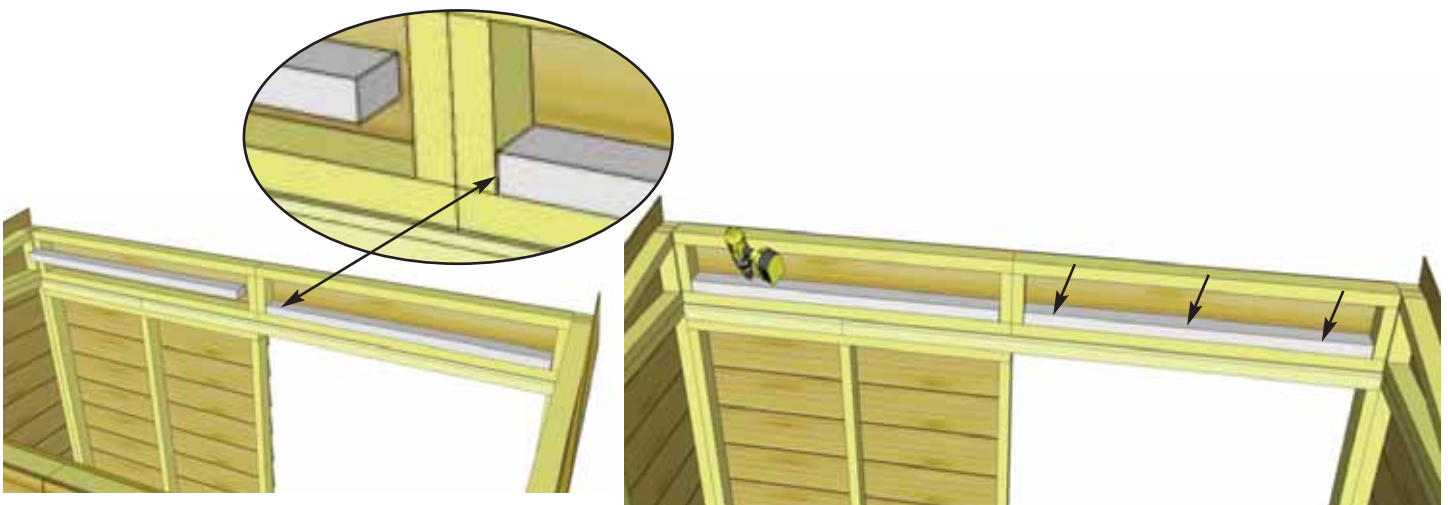

27. With Extender Walls attached, position **Extender Wall Cleats** (2 @ 1 1/2" x 2 1/2" x 42 3/8") in the lower section of each Extender Wall. Attach with **3 - 2 1/2" Screws** per cleat.



28. Align **Horizontal Wall Cleats** (1 @ 3/4" x 3 1/2" x 70", 1 @ 3/4" x 3 1/2" x 21") flush with top of Rear Wall framing. To help strengthen the Rear Walls, there is a short and a long wall cleat which meet off-center from the seam between walls. Attach Cleats with **8 - 1 1/4" Screws**.

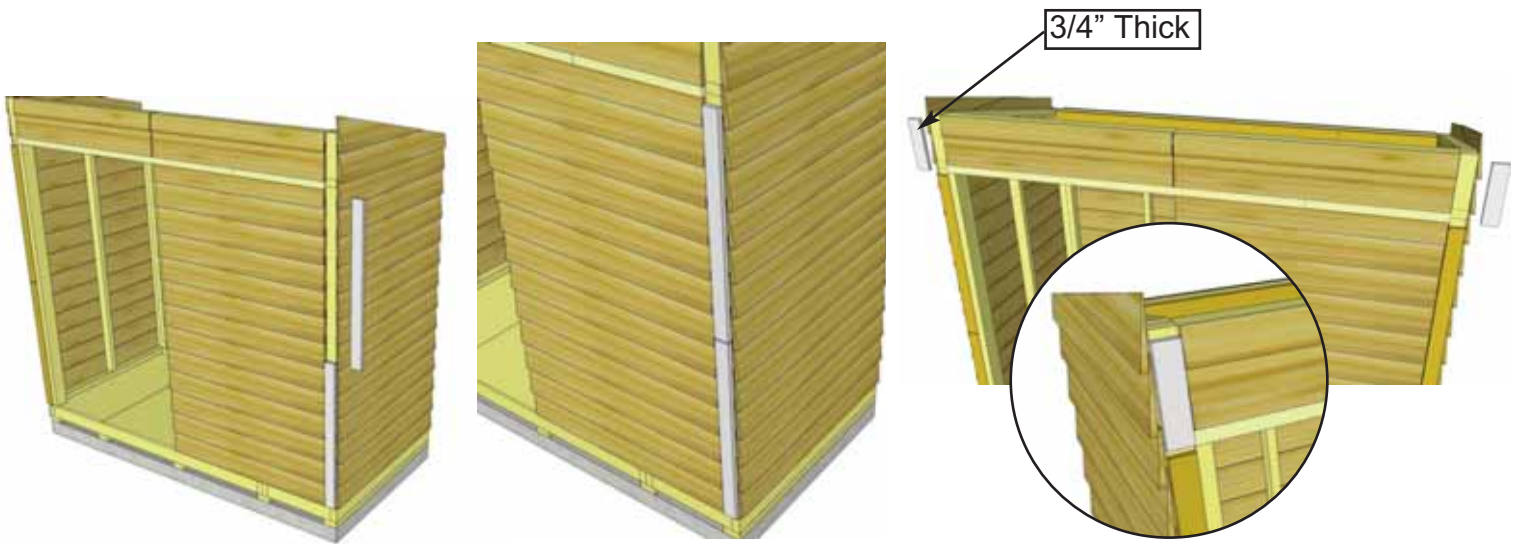

29. Position and attach **Front Right Corner Filler Trims** (2 @ 7/8" x 2 1/2" x 36") with **4 - 1 1/2" Finishing Nails** per piece.

Attach **Front Top Corner Filler Trim** (2 @ 3/4" x 2 1/2" x 10") to both sides as shown above. Use **2 - 1 1/2" Finishing Nails** per piece. Filler trims won't be visible because they serve as nailing strips for the Corner Trims which will be attached later.

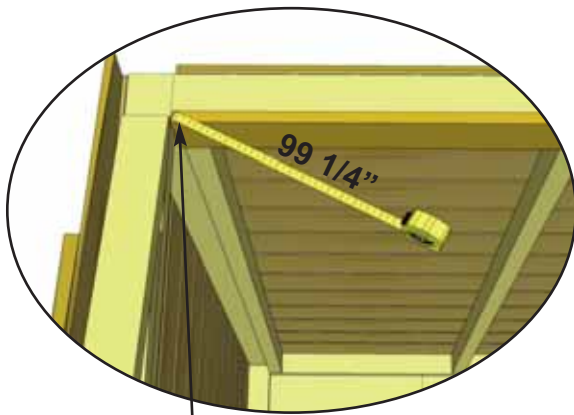

Advice: Prior to fastening walls and installing rafters, take time to confirm your walls are level, square and plumb.

Measure diagonal at top and bottom of walls corner-to-corner. This should be approximately 99 1/4". More importantly, if measurements are not within 1/4", your walls are not square. Adjusting now will make it easier to install roof section.

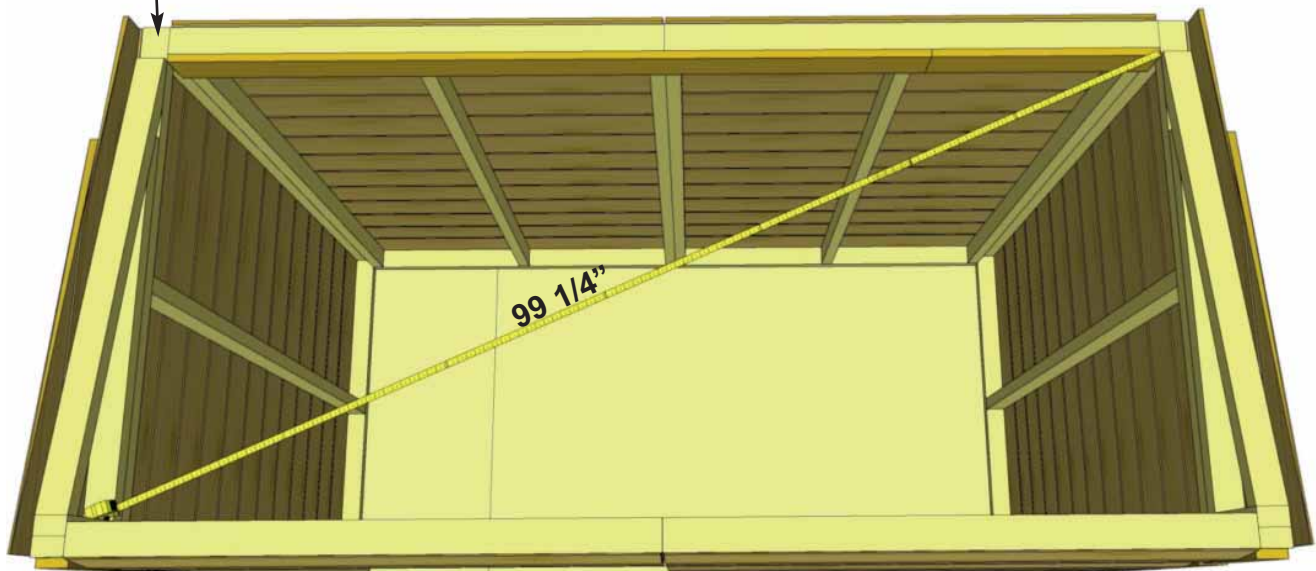

30. To complete Wall Section, attach bottom 2x3 wall plates to plywood floor with **20 - 2 1/2" Screws**. Confirm Doorway opening is 44" wide. Prior to securing, make sure wall panels are aligned correctly on the floor. Refer to **Step 11**. Wall siding should overhang floor while 2x3 wall plates should sit flush with floor.

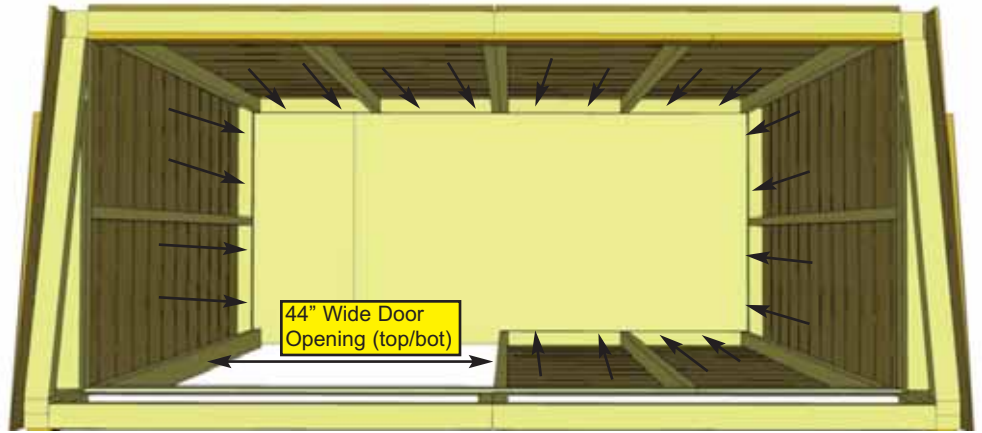

Optional - Caulking seams will help prevent moisture from entering at seam. Caulking not included in kit.

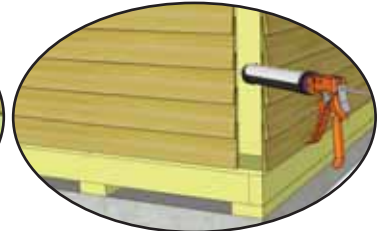

C. Rafter and Roof Section

Exploded view of all parts necessary to complete the Rafter and Roof Section. Identify all parts prior to starting.

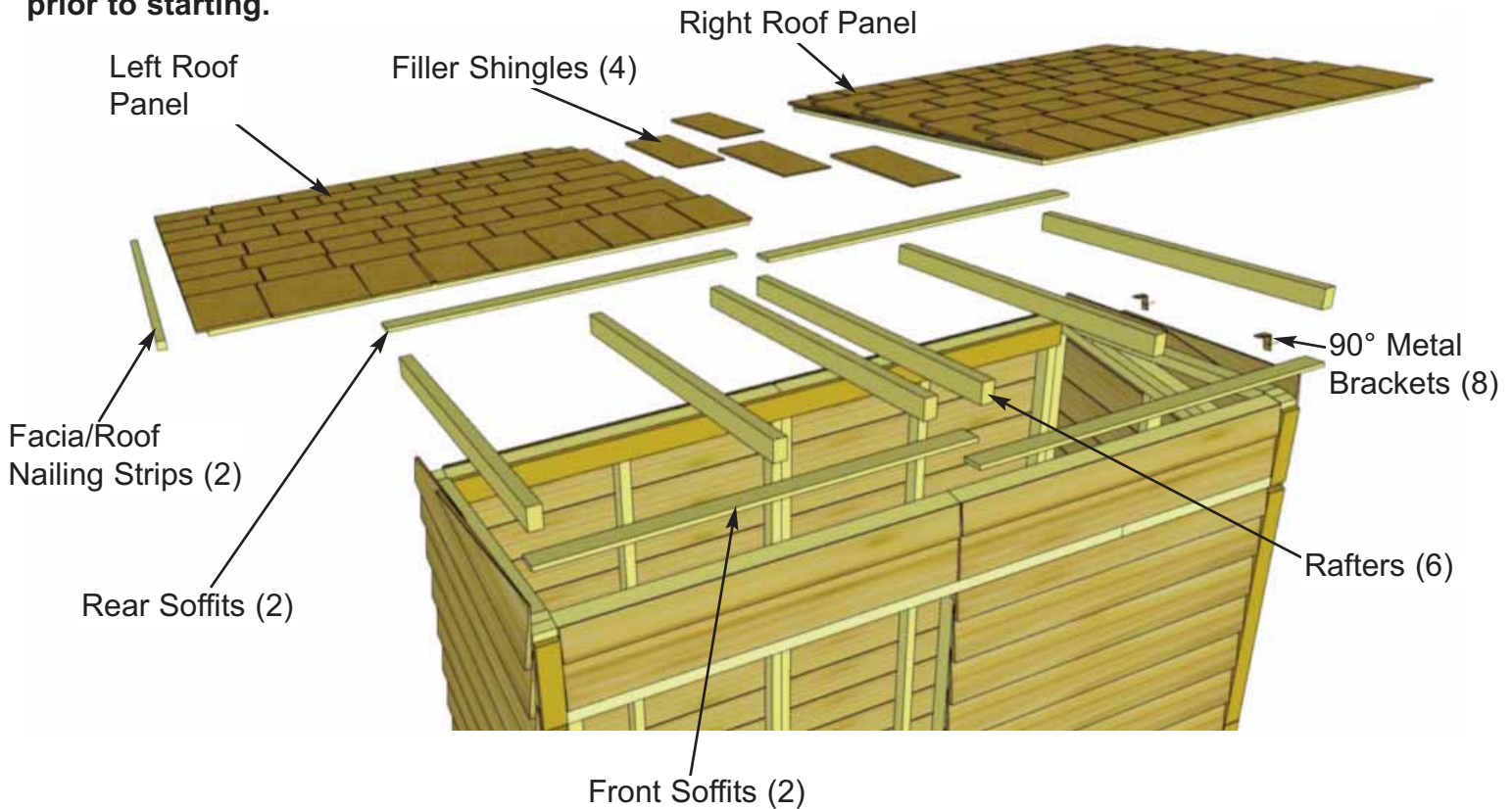

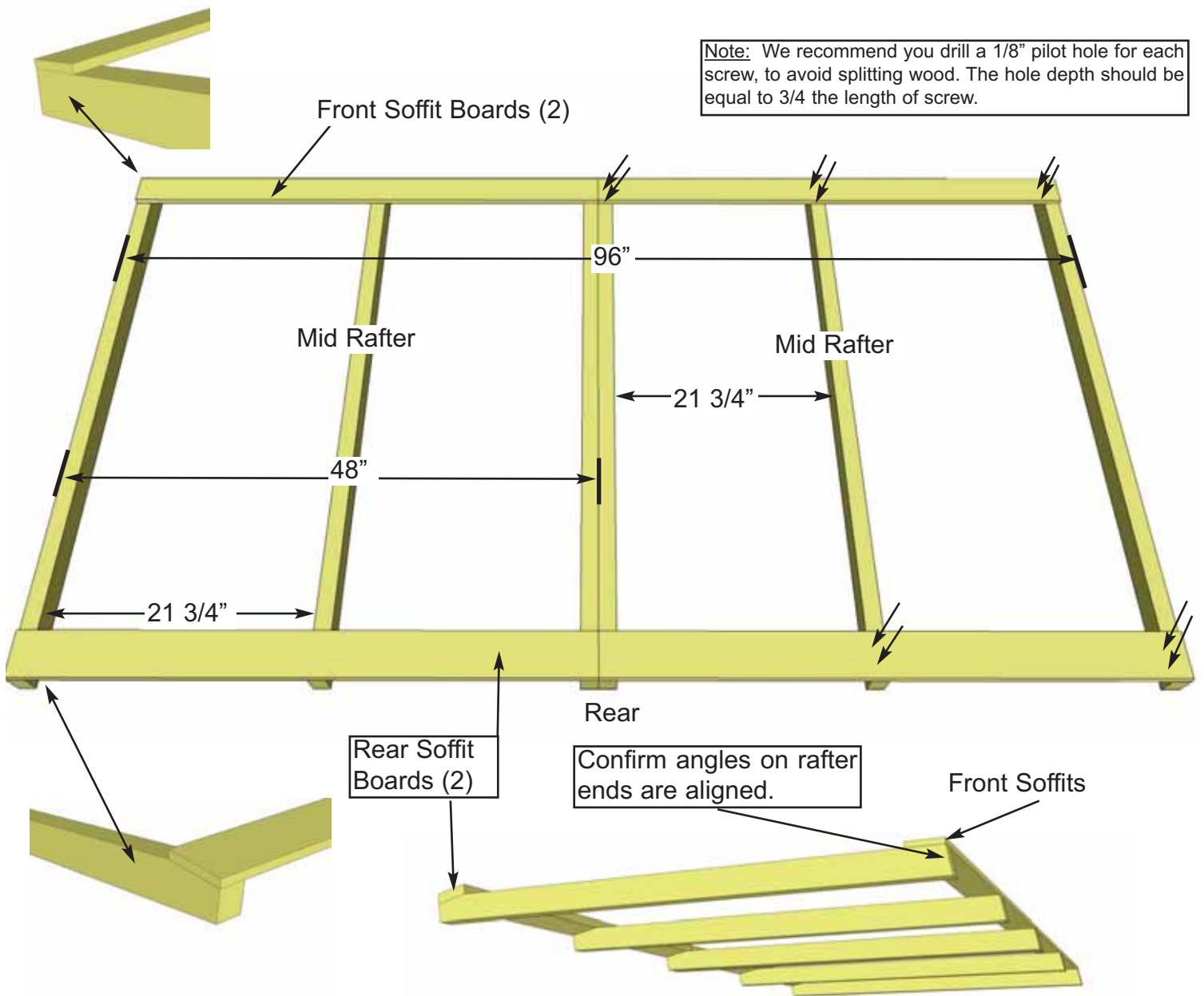

31. Locate 6 **Rafters**, 2 **Rear Soffits** and 2 **Front Soffits**. Lay out on level ground and assemble as shown in Illustrations **A** through **C** below. Attach Soffit Boards flush to end of outside rafters with 2 - 1 1/4" screws per rafter end. **Important:** Drill pilot holes in Soffit ends to prevent splitting. Measure and attach interior Rafters as illustrated above. Measure and attach remaining Soffit/Rafter connections using 2 - 1 1/4" screws per rafter/soffit.

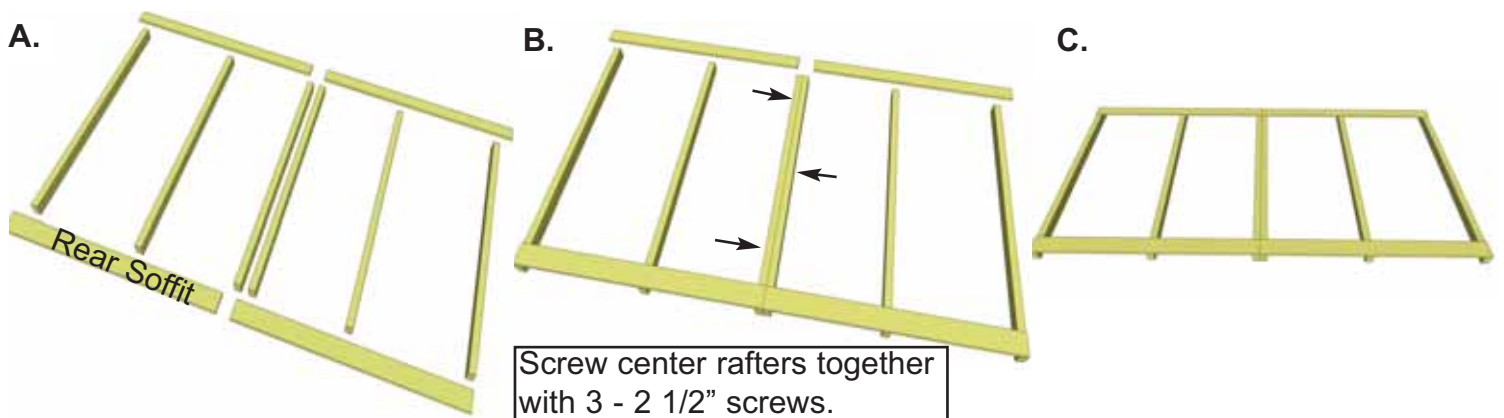

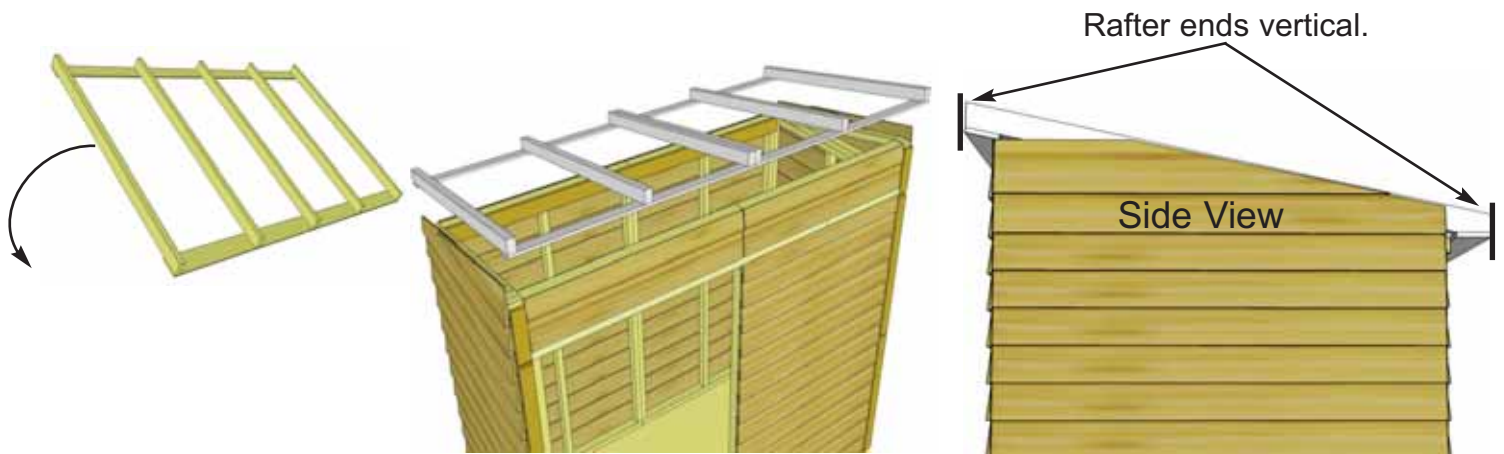

32. Carefully flip completed Rafter Section over so Front Soffit is facing the front and place on GardenSaver walls. **Note:** Double check that your Rafter Section is positioned correctly by ensuring the ends of the Rafters are sloped vertically as shown above.

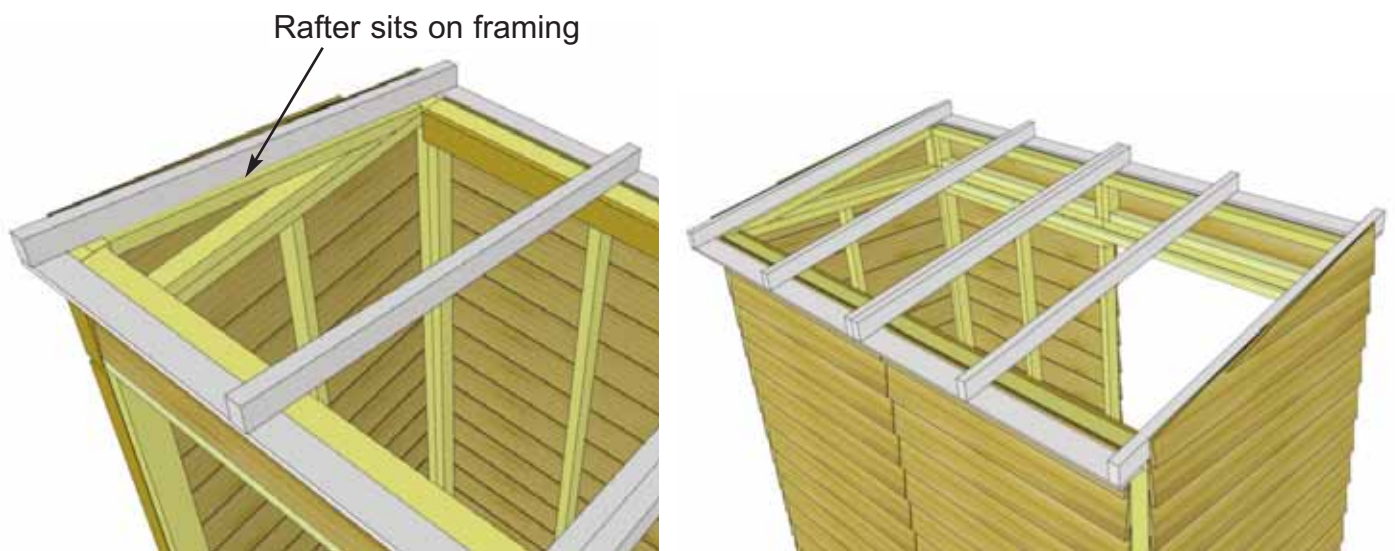

33. Position completed Rafter Section on top of walls. Outside Rafters will sit on Extension Wall framing and be positioned equally from side to side.



34. When Rafter Section is positioned correctly, both Front and Rear Soffits will sit approximately 1/8" away from wall siding. This can vary slightly.

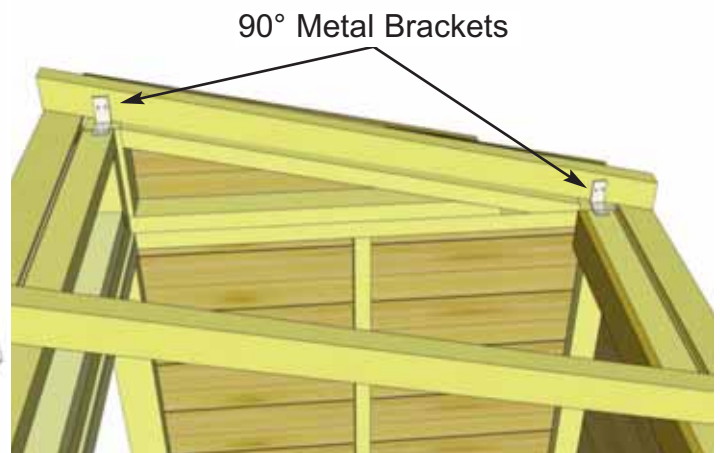
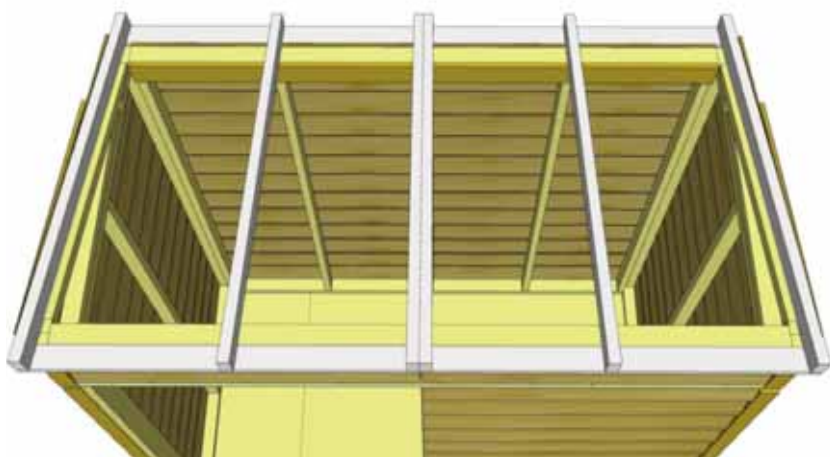

35. With Rafter Section correctly aligned, secure rafters to walls using **90° Metal Brackets**. Start with outside rafters and secure 2 Brackets with **4 - 1 1/4" Screws** per bracket. Screw into Wall Extension Framing at the front, and Wall Panel top framing at the rear. Complete both sides.

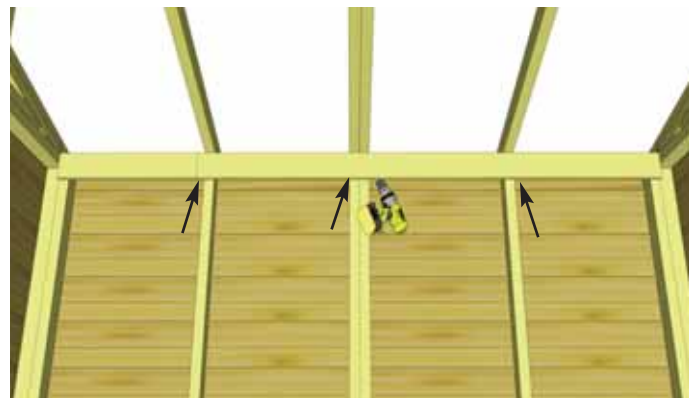
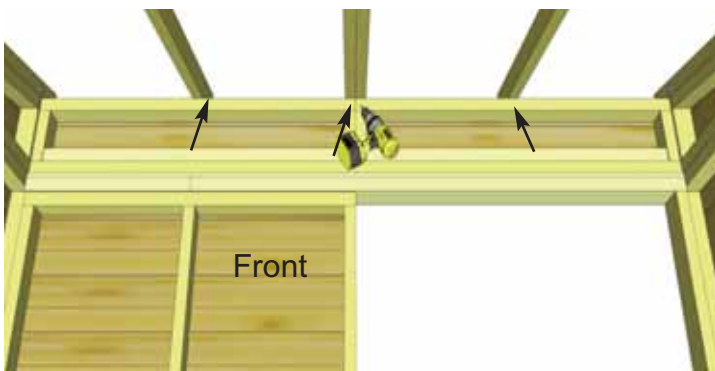

36. With outside rafters properly secured, completely secure remaining interior rafters using **8 - 3" Screws**. Screw into rafters from inside of Extension Wall framing at front of shed and inside Rear Wall framing at rear of shed, behind Horizontal Wall Cleats.

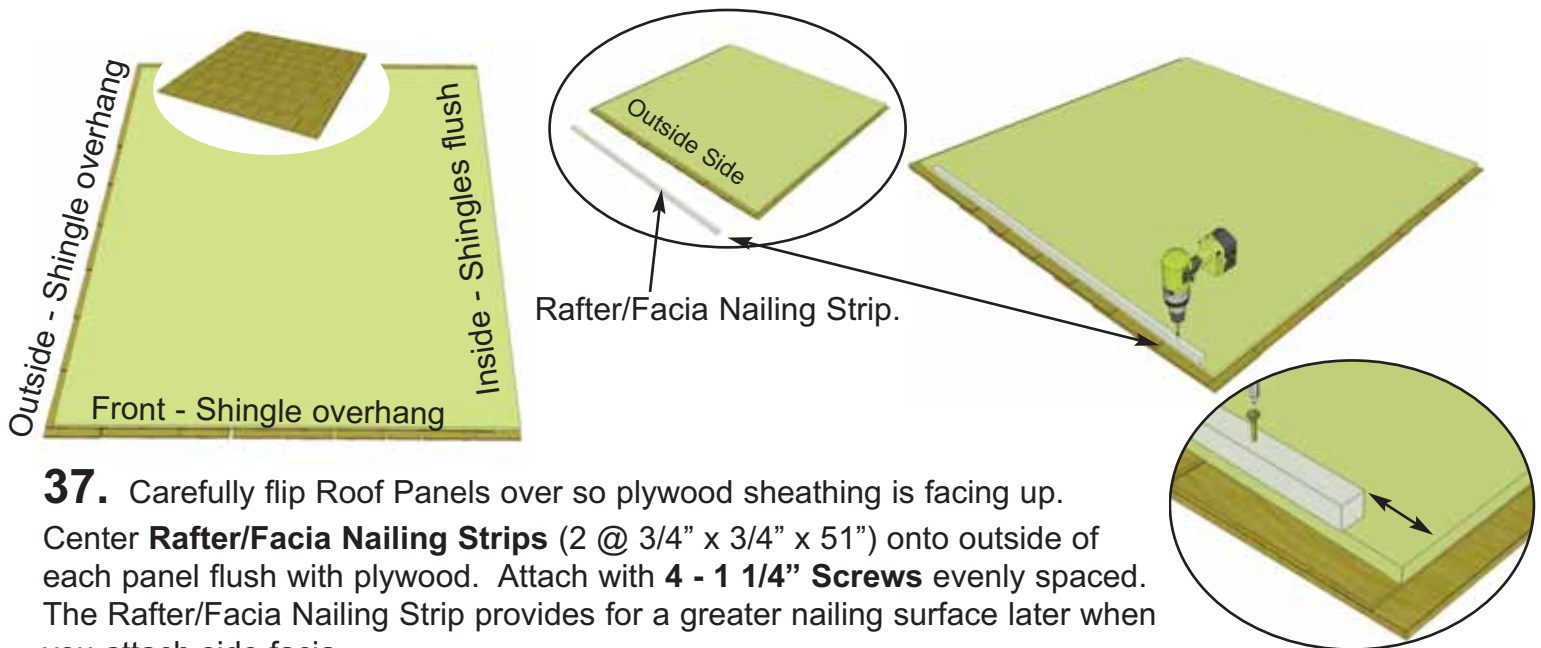

37. Carefully flip Roof Panels over so plywood sheathing is facing up. Center **Rafter/Facia Nailing Strips** (2 @ 3/4" x 3/4" x 51") onto outside of each panel flush with plywood. Attach with **4 - 1 1/4" Screws** evenly spaced. The Rafter/Facia Nailing Strip provides for a greater nailing surface later when you attach side fascia.

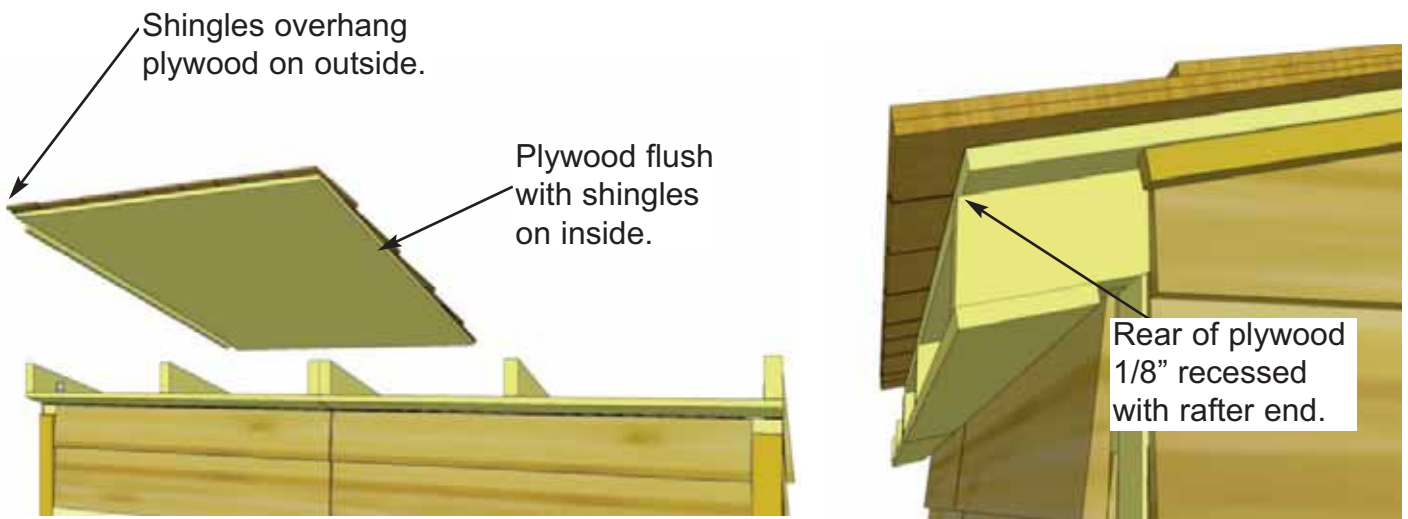

38. Correctly orientate Left Side Roof Panel, with shingles overhanging plywood on the side of the shed and flush with plywood to the middle. Place on rafters with rear of plywood just about flush with rafter ends but just slightly recessed. Doing so allows Rear Fascia to sit better.

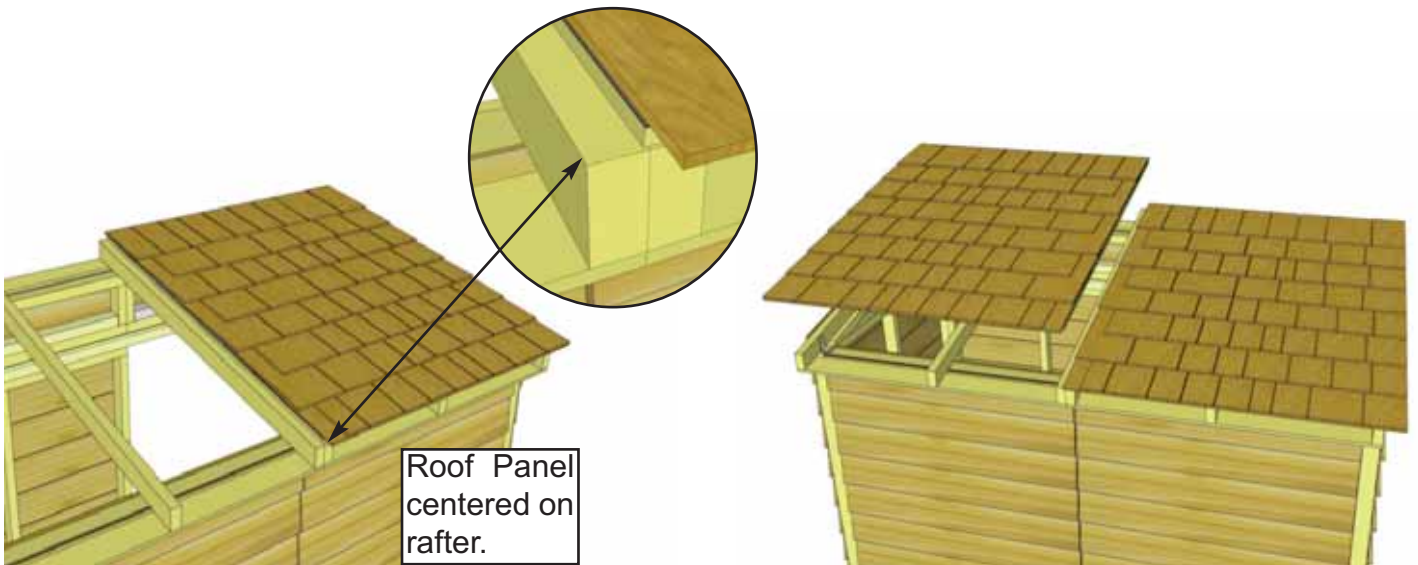

39. For correct Roof Panel position, align panel so plywood sits evenly on Center Rafters. Complete both roof Panels.

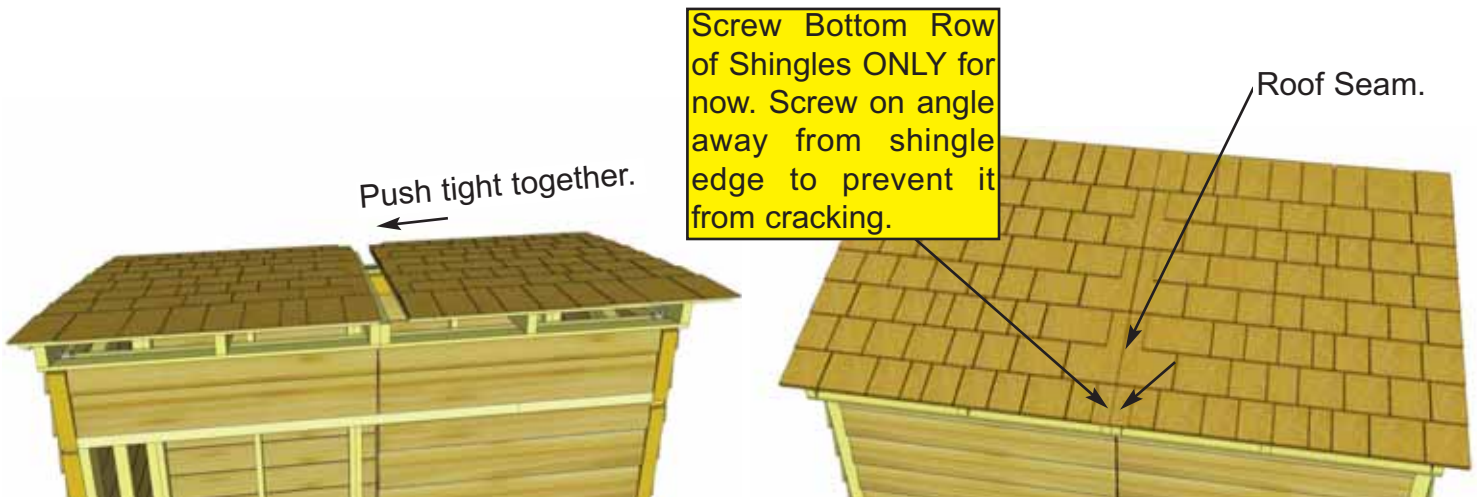

40. With Roof Panels aligned, screw panels down to center rafters with **2 - 2 1/2" Screws** in **Bottom Row of Shingles Only** (1 screw per panel).

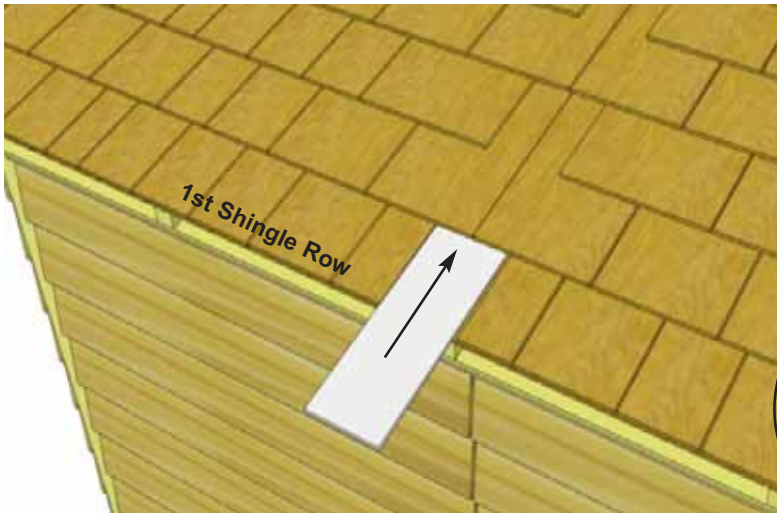

41. To cover roof seam, slide one **Filler Shingle** (5 1/2" wide) up and underneath second shingle row. Push or bang filler carefully with a hammer until evenly spaced and butt is even with other 1st row of shingles.

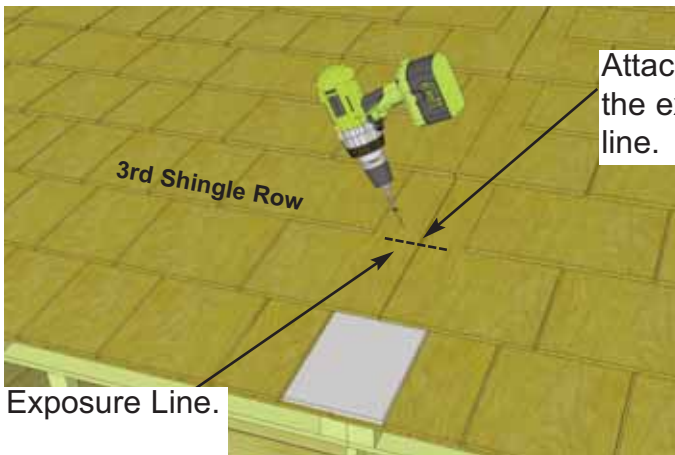
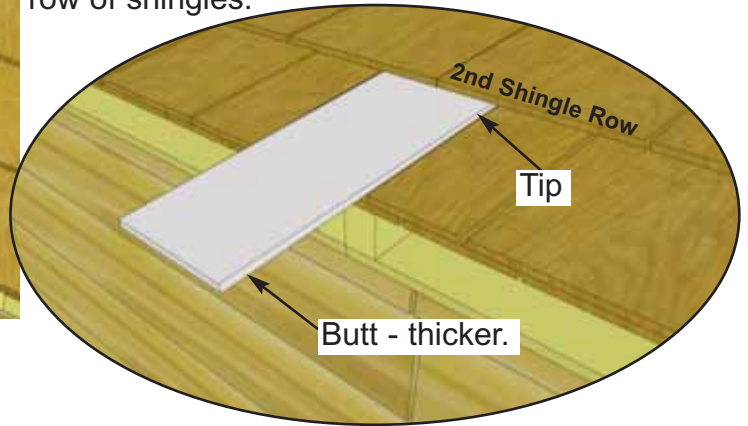

Exposure Line.

Attach above the exposure line.

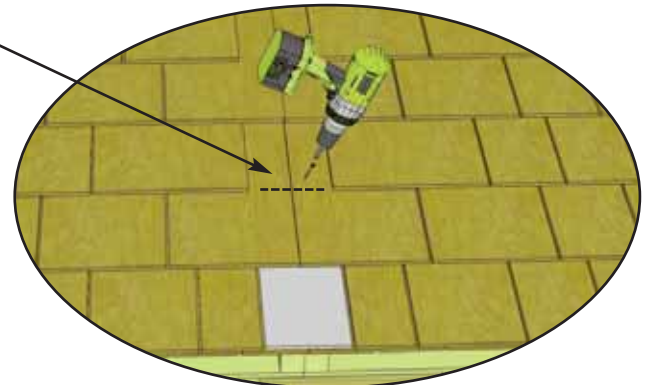

42. Screw first filler shingle down to rafters using 1 - 2 1/2" **Screw** per panel (2 in total). Screw on slight angle and make sure to screw into rafter. Screw slightly above 3rd row of shingles (exposure line). This way, the screw will get covered up when you install your 2nd Filler Shingle and will prevent leaking.

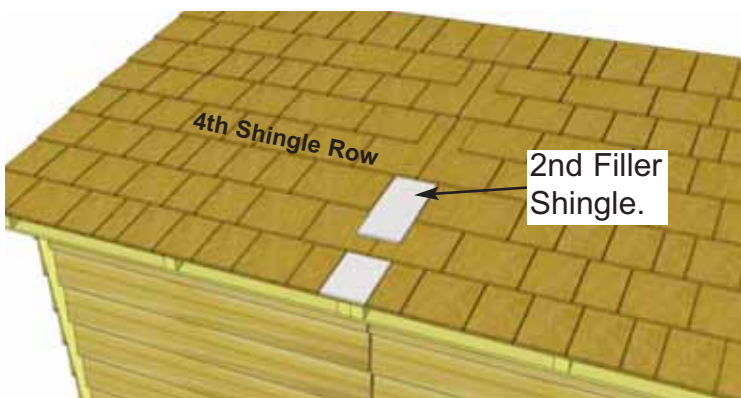

43. Slide 2nd **Filler Shingle** up and underneath fourth shingle row. Follow **Steps 41 - 42** to align and attach.

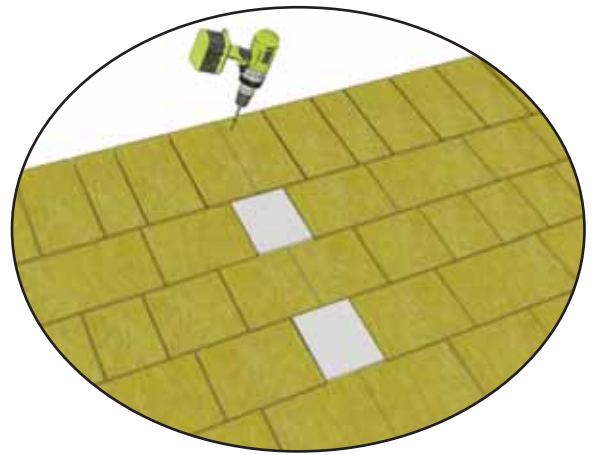
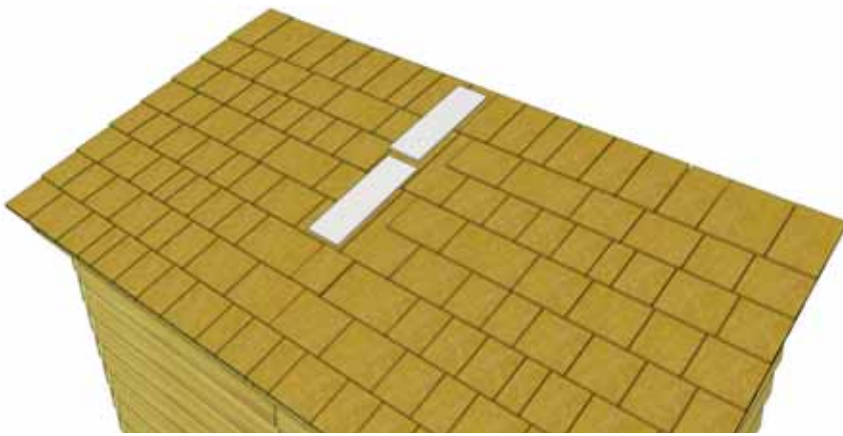

44. Slide 3rd and 4th **Filler Shingles** up and underneath appropriate shingle rows and follow **Steps 41 - 42** to align and attach. On last filler, screws will get covered by Roof Ridge Board (4 1/2" wide).

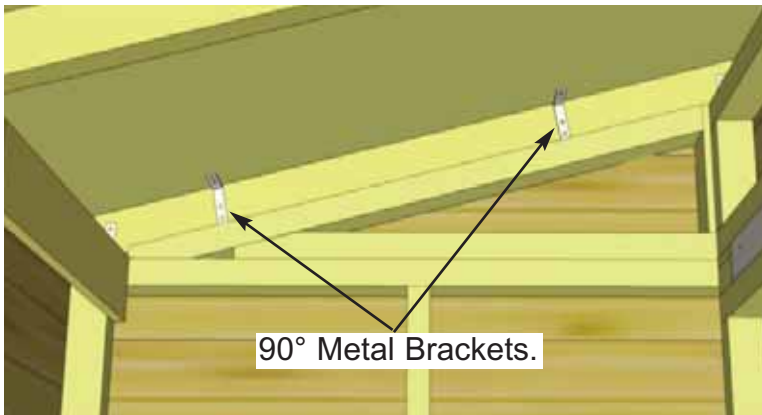

90° Metal Brackets.



45. Secure roof panels to walls at both ends by positioning **2 - 90° Metal Brackets** on plywood and outside rafters. Secure with **4 - 1 1/4" Screws** per Bracket, complete both sides.

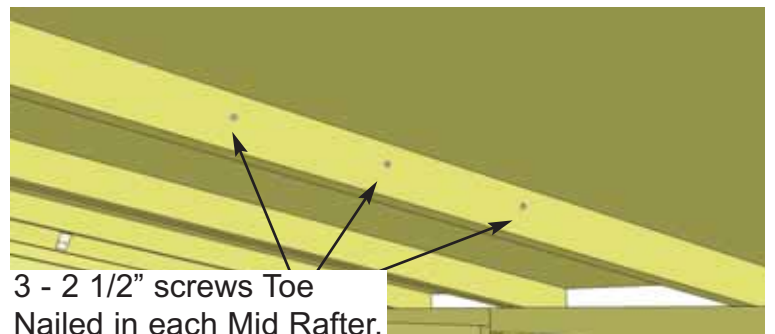
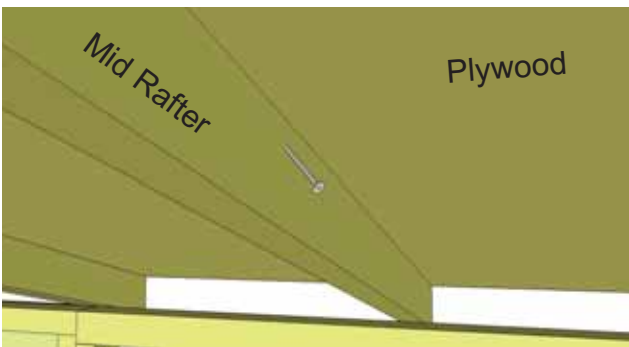

3 - 2 1/2" screws Toe Nailed in each Mid Rafter.

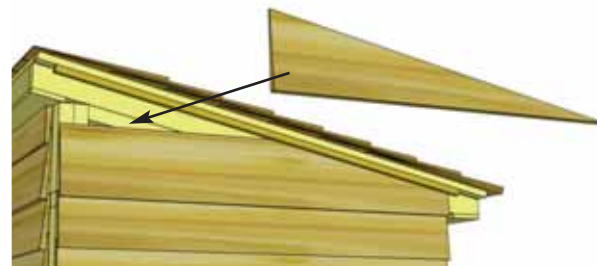
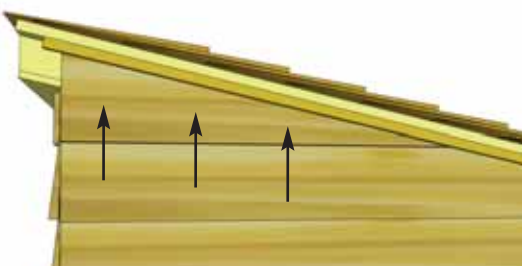

46. To further secure roof panels from the inside, drill pilot holes on an angle in each panel's Mid Rafter (3 per Rafter). Using **3 - 2 1/2" Screws**, secure rafters to plywood. **Note:** from outside if possible, have a helper push roof panel down so plywood sits flush against rafter while securing. Locate **Top Siding Piece for Angled Wall Extender (L/R)**. Position top siding on wall extender and align as shown above. Attach with 3 - 1 1/2" finishing nails to top wall framing. There are left/right top siding pieces. Use rough surface side out.

D. Trim & Miscellaneous Section

Exploded view of all parts necessary to complete the Skirting, Trim, Facia and Miscellaneous Pieces. Identify all parts prior to starting.

(Not Shown: Rear Facia, Rear Middle Trim, Interior Door Header)

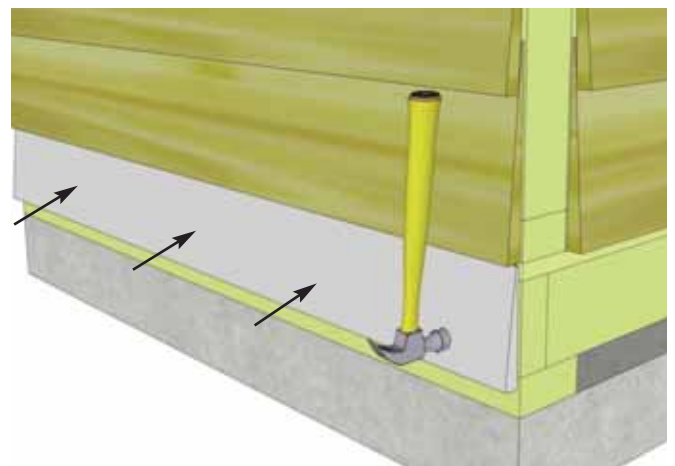
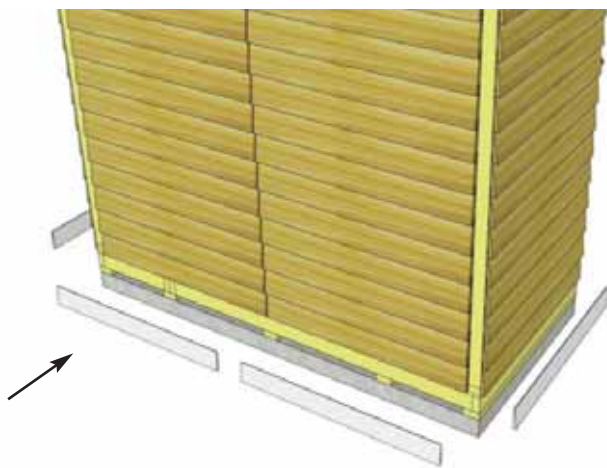
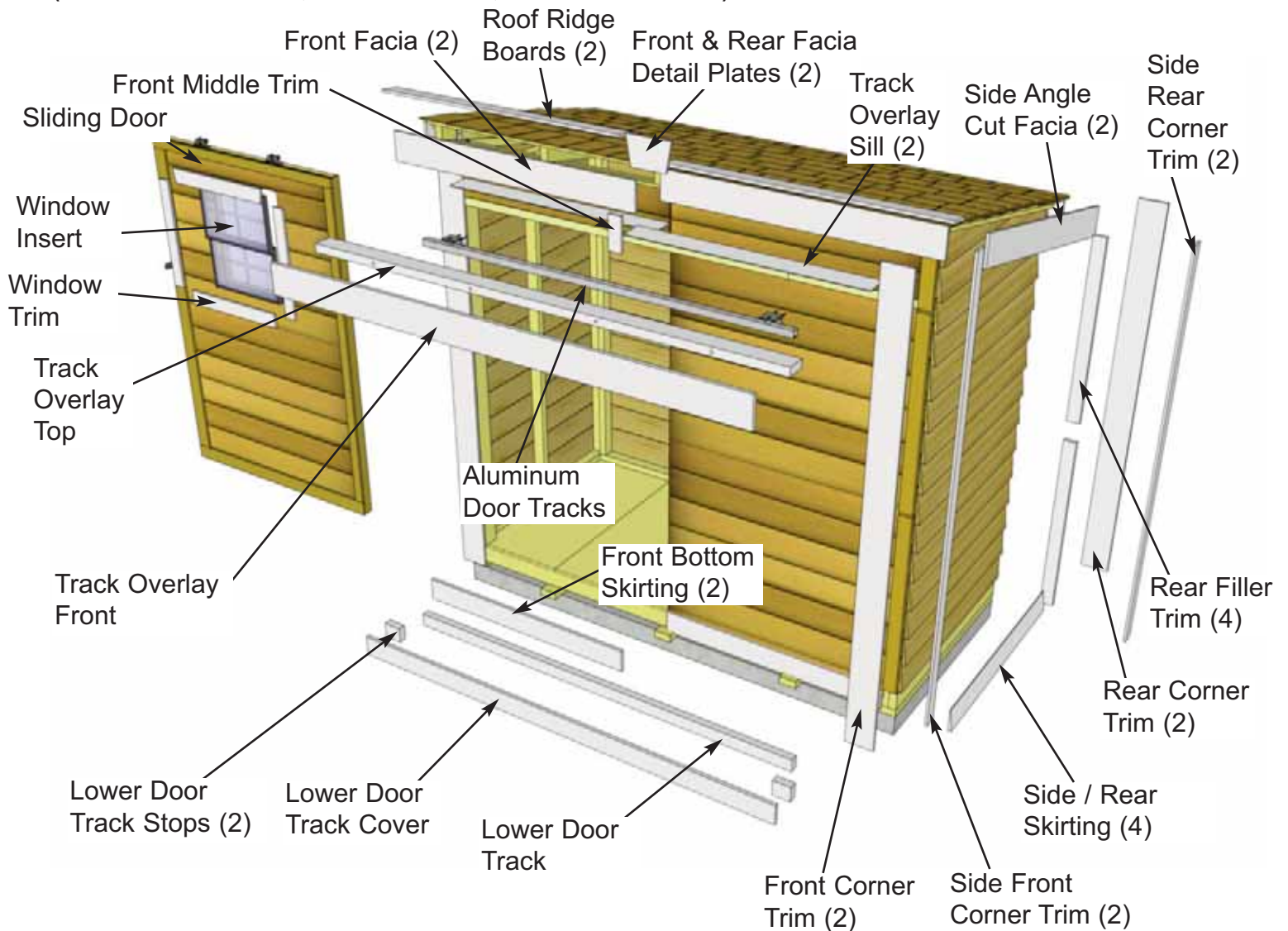

47. Attach **Bottom Skirting** (4 @ 3/4" x 4 1/2" x 45 1/4" - bevel) around the base of the shed. Skirting will hide floor framing. Start with side skirting pieces first and attach with **4 - 1 1/2" Finishing Nails** per piece.

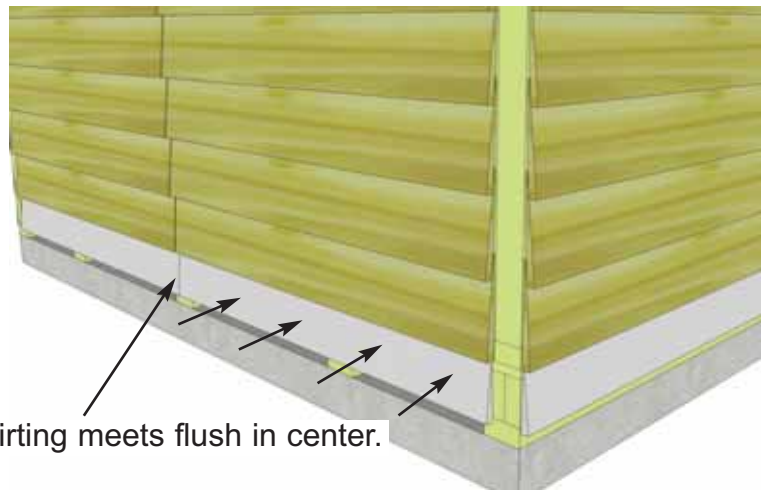

Skirting meets flush in center.

48. Rear skirting pieces will meet together in the center. Secure with **4 - 1 1/2" Finishing Nails** per piece.

Skirting meets flush in center.

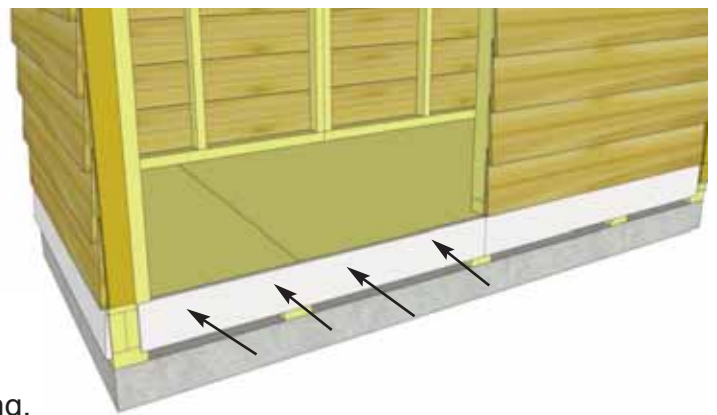

49. Attach **Front Skirting** (2 @ 1/2" x 4" x 45 1/4") with **4 - 1 1/4" Screws** per piece. Front Skirting does not have a bevel cut. Align as per side and rear skirting.

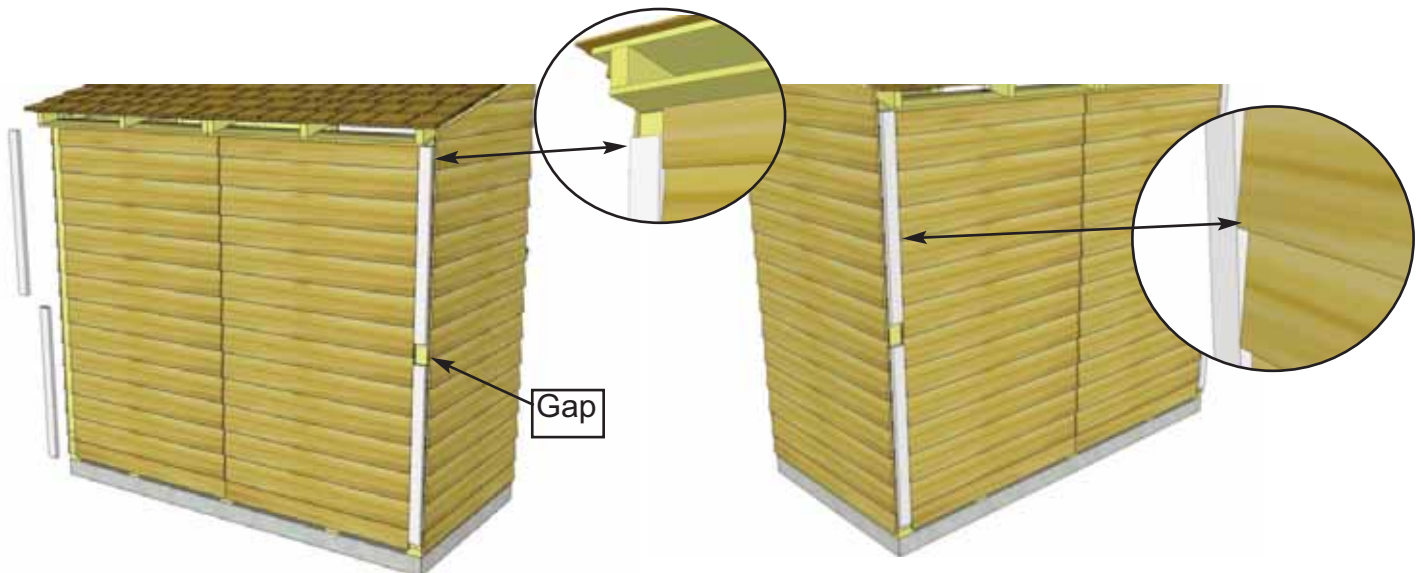

50. Locate **Rear Corner Filler Trims** (4 @ 7/8" x 2 1/2" x 36"). Fillers are essentially nailing strips and will not be visible once additional corner trims are attached later. There will be two 36" long fillers per corner. Position with a slight gap in the middle and attach with **4 - 1 1/2" Finishing Nails** per piece.

See Step 60 to confirm Lower Door Track and Track Stops fit between Wide Front Corner Trim

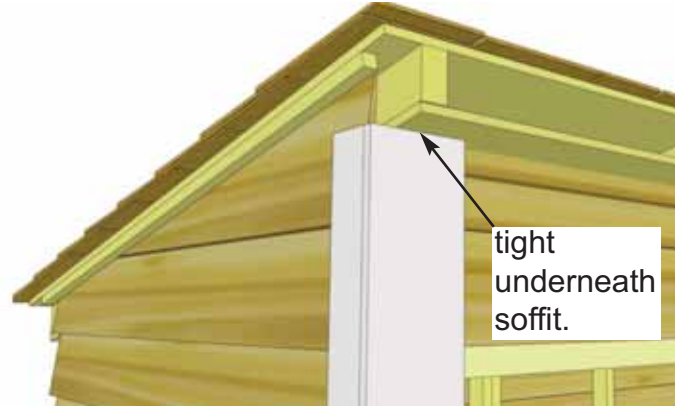
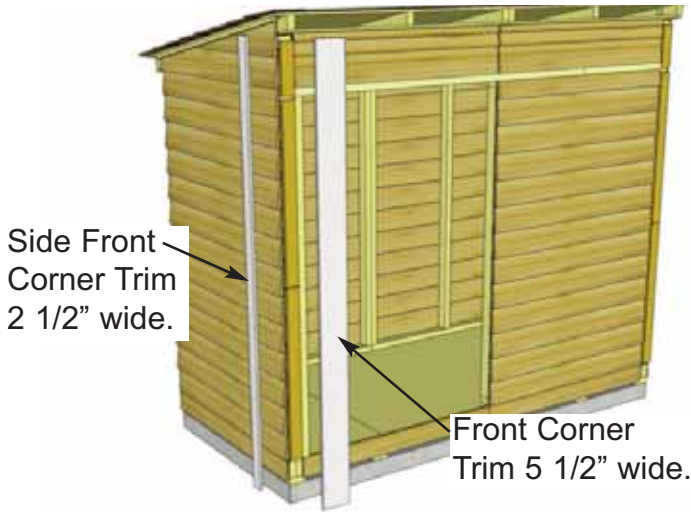

51. To Trim out front corners, locate a **Side Front Corner Trim** (1/2" x 2 1/2" x 88 3/4") and a **Front Corner Trim** (1/2" x 5 1/2" x 88 3/4").

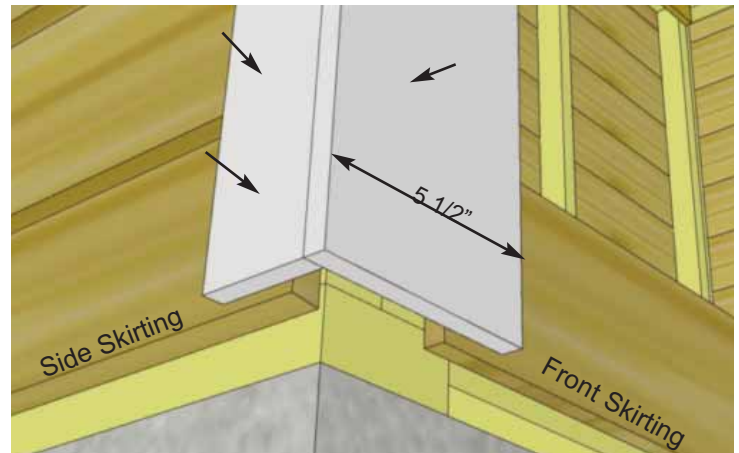

52. Place both trims in front corner and align as illustrated above. Do a dry run prior to attaching to achieve best fit. Start with 5 1/2" wide Front Corner Trim and align tight underneath soffit to determine vertical height. Attach with **8 - 1 1/2" Finishing Nails** per piece. Position and attach Side Front Corner Trim (2 1/2" wide) using **8 - 1 1/2" Finishing Nails**, aligning at bottom with wide trim. Complete other front corner the same.

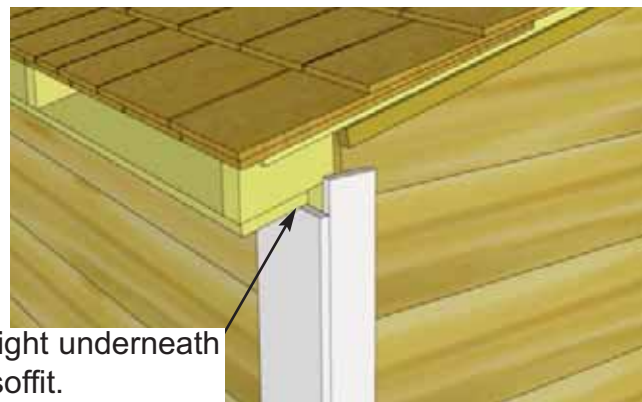

53. To completely trim out rear corners, locate **Side Rear Corner Trims** (1/2" x 2 1/2" x 80") and **Rear Corner Trims** (1/2" x 5 1/2" x 79"). Align and attach as per **Step 52**.

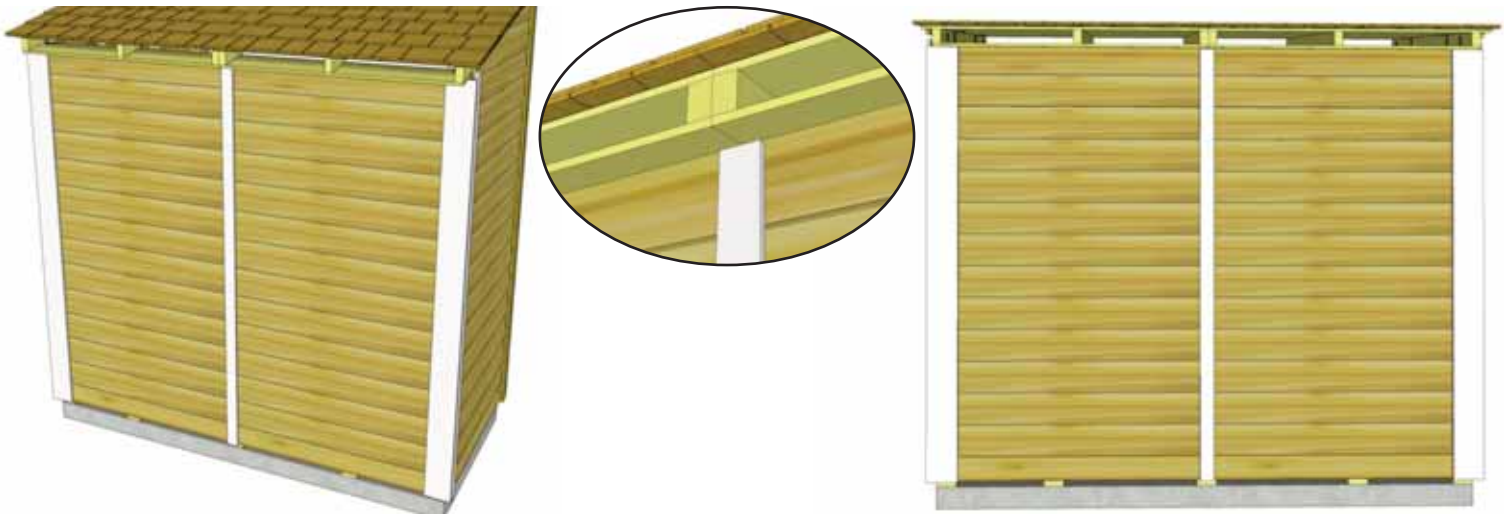

54. Attach **Rear Middle Trim** (1/2" x 2 1/2" x 79") where wall panels come together at rear seam. Attach with **8 - 1 1/2" Finishing Nails** aligning tight underneath soffit and center on seam.

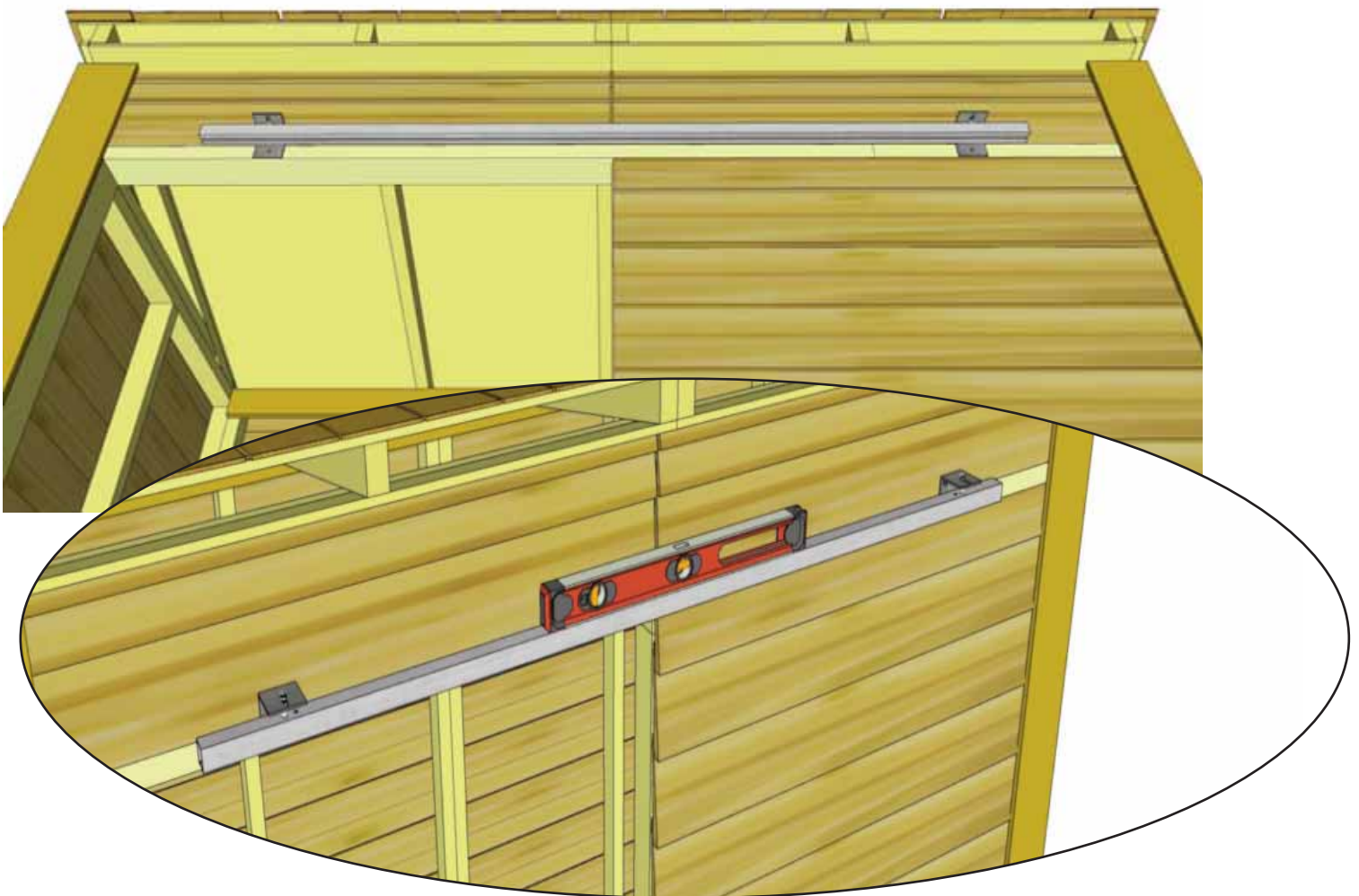

55. Locate **Aluminum Door Track** and position above doorway evenly spaced between wide front corner trim. Ensure Track is level.

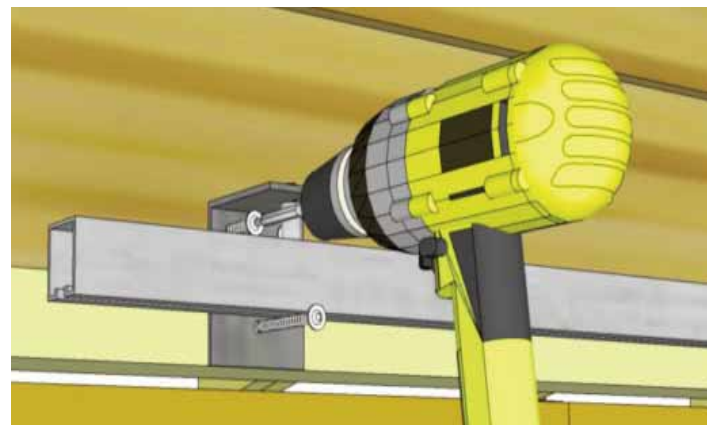
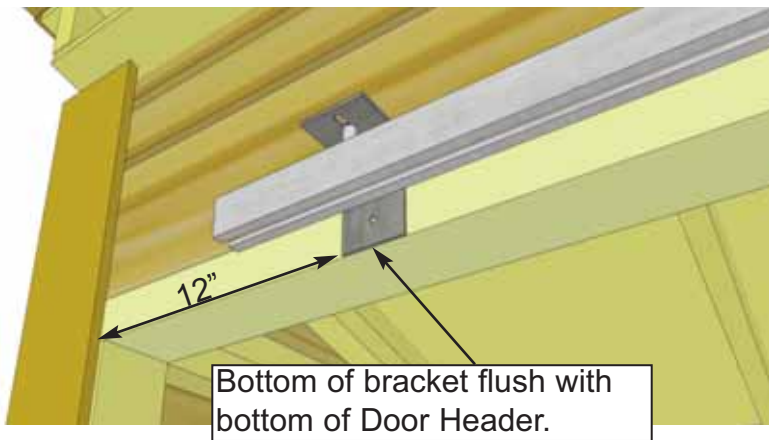

Attach 1 Torx Screw per bracket to hold in place while aligning track.



56. Once track is evenly spaced from side-to-side (approximately 12" from bracket to wide trim on both sides) and bottom of bracket is flush with bottom of header, attach with **1 - 1 1/2" Torx Screw** per bracket to hold in place. Attach 2nd bracket with another **1 1/2" Torx Screw**. Check level once again. Complete attachment of remaining Torx Screws on brackets of Track.

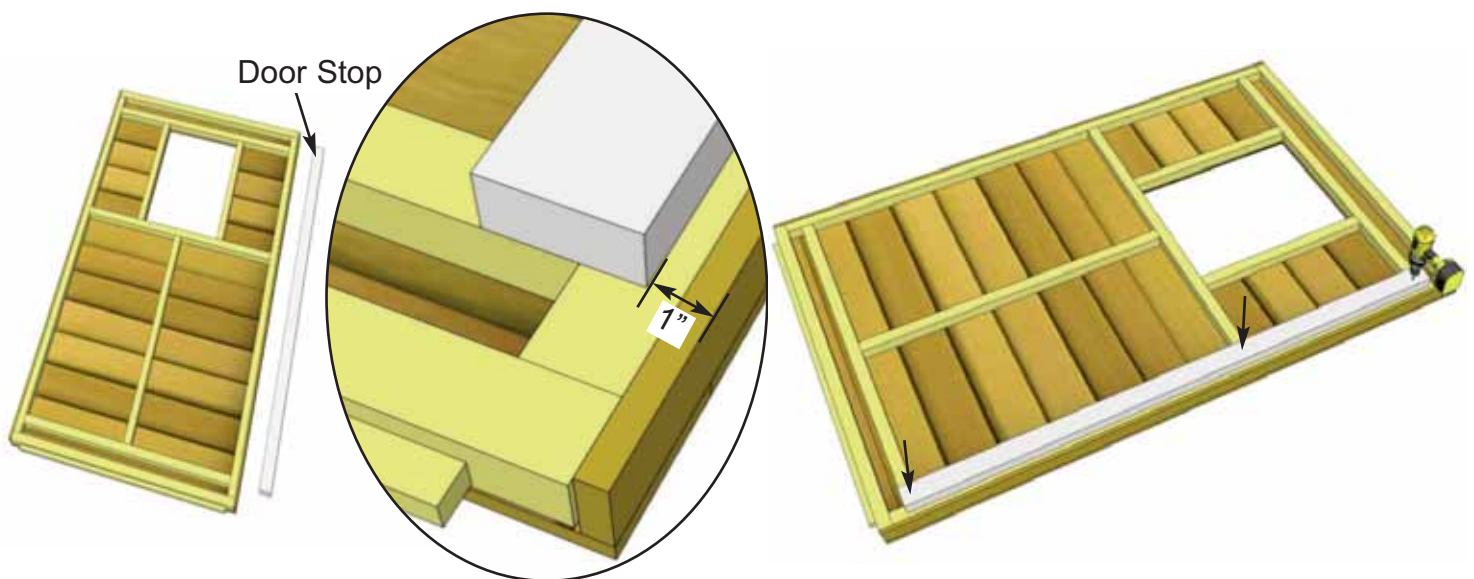

57. Locate Sliding Door and flip over onto a clean, dry and level spot. Position **Door Stop** (1 1/2" x 2 1/2" x 66 7/8") on left inside frame of door as shown above. Position 1" from outside trim of door as shown above. Attach with **3 - 2 1/2" Screws** into horizontal door framing.

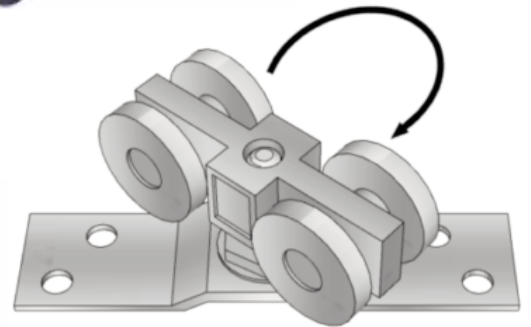
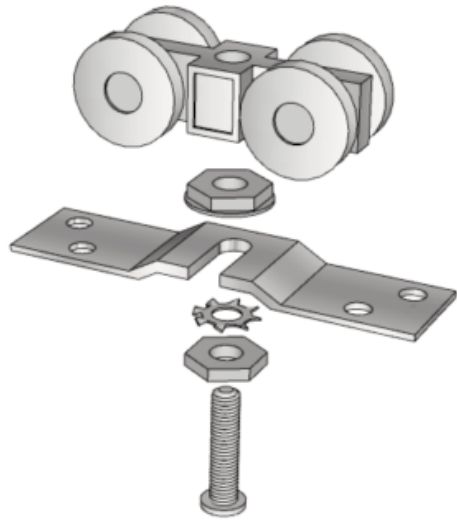

Twist Roller Cart onto bolt.
After door is hung, you may need to
adjust this until door hangs straight
up and down at desired height.



12 1/2"

12 1/2"

58. Locate **Roller Assemblies**. Before attaching to top of doors, assemble the units as shown above. Attach two Roller Assemblies onto door with **4 - 1 1/4" Screws** per Assembly, center on the door framing **12 1/2"** from each end as shown above.

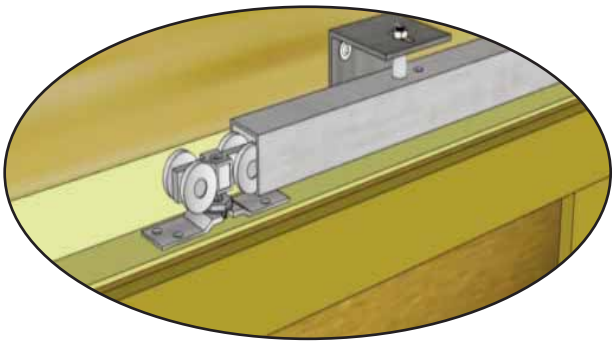

59. Pick up Sliding Door and carefully slide Rollers into the Aluminum Door Track.

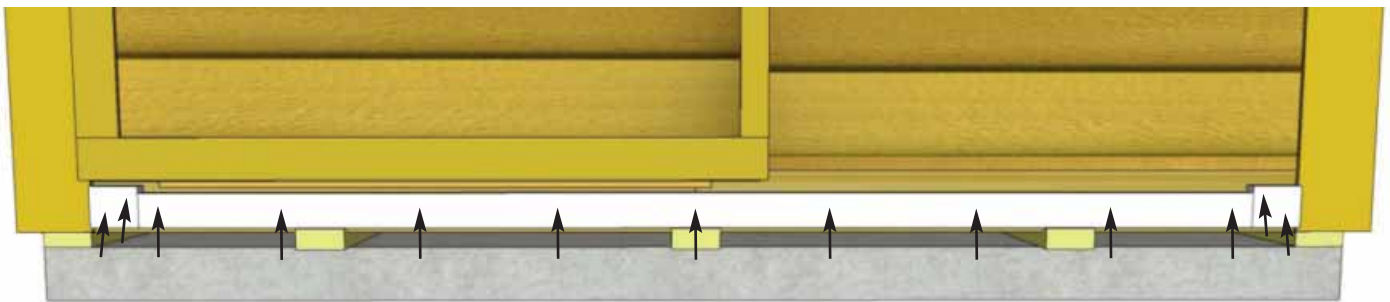
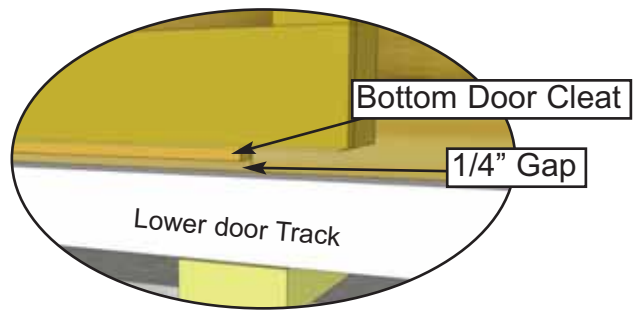
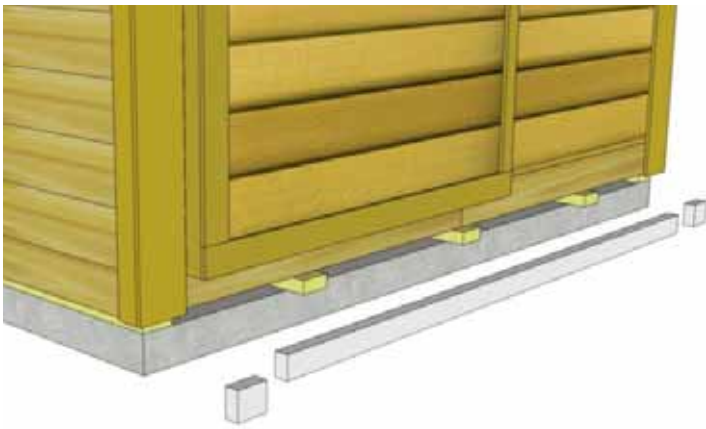

60. Locate **Lower Door Tracks** and **Door Stops**. Center Door Track side-to-side and resting on Long Floor Runners. Bottom of Door Stops and Door Tracks should be flush with each other. Secure Door Tracks to shed with **9 - 3" screws**. Secure Door Stops with **2 - 3" screws** per piece.

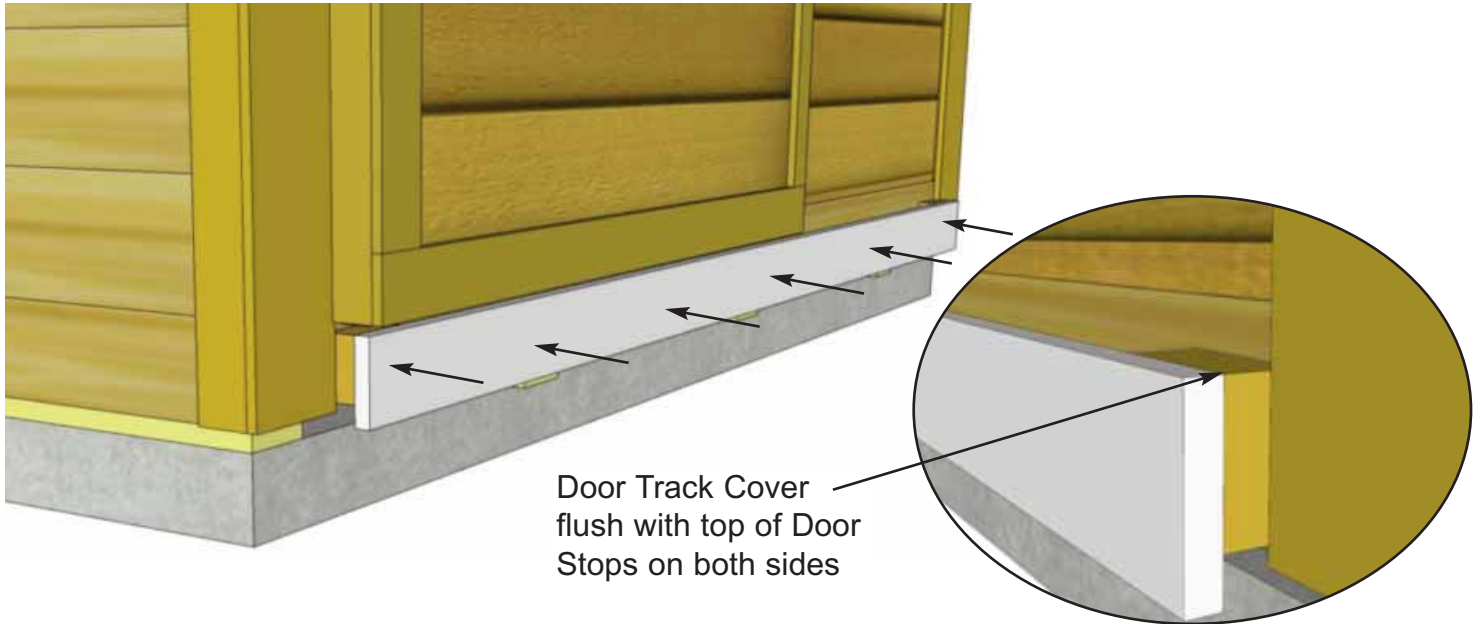
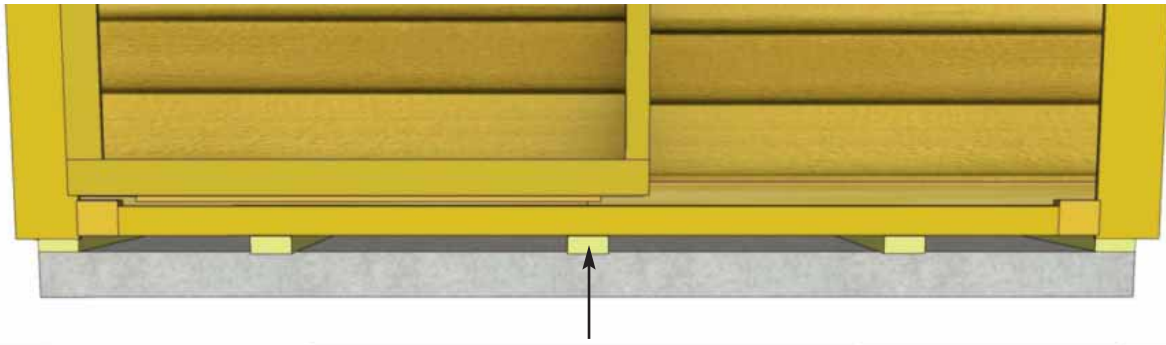

61. Locate **Door Track Cover**. Line up so Track Cover is flush with outside edges of Door Stops. This creates an enclosure so the door can not slide out of the track. Track Cover with **6 - 2 1/2"** screws.

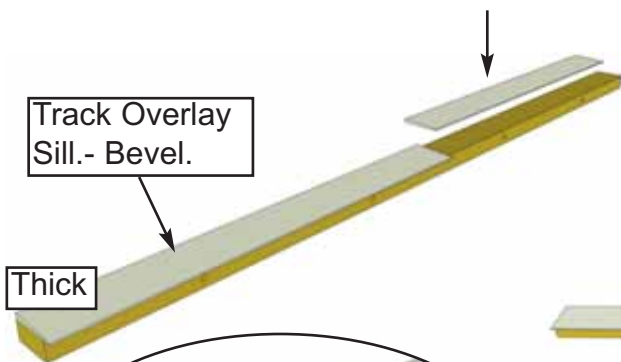

IMPORTANT -
Slide door back and forth to confirm door slides freely prior to attaching Top Track Overlay. Track Brackets are slotted so door position can be adjusted horizontally, as well as vertical position with Roller Assemblies.

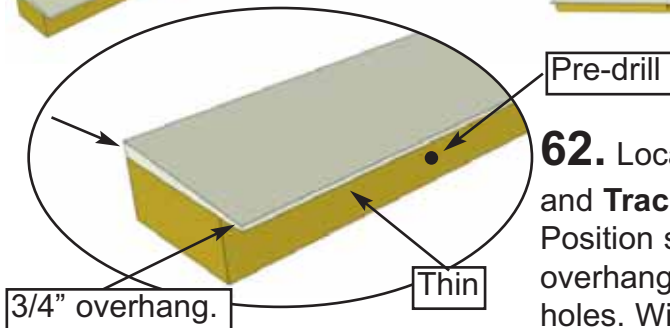
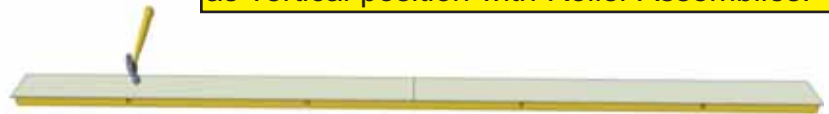

62. Locate **Top Track Overlay** (1 1/2" x 3 1/2" x 87 3/4") and **Track Overlay Sill** (2 @ 1/2" x 4 1/4" x 43 7/8" - Bevel). Position sill on top face of track overlay. Tip of bevel sill will overhang by 3/4" on the track overlay edge with the pre-drill holes. With sill properly positioned, nail sill down with **4 - 1 1/2" Finishing Nails**. Complete both sill attachments.

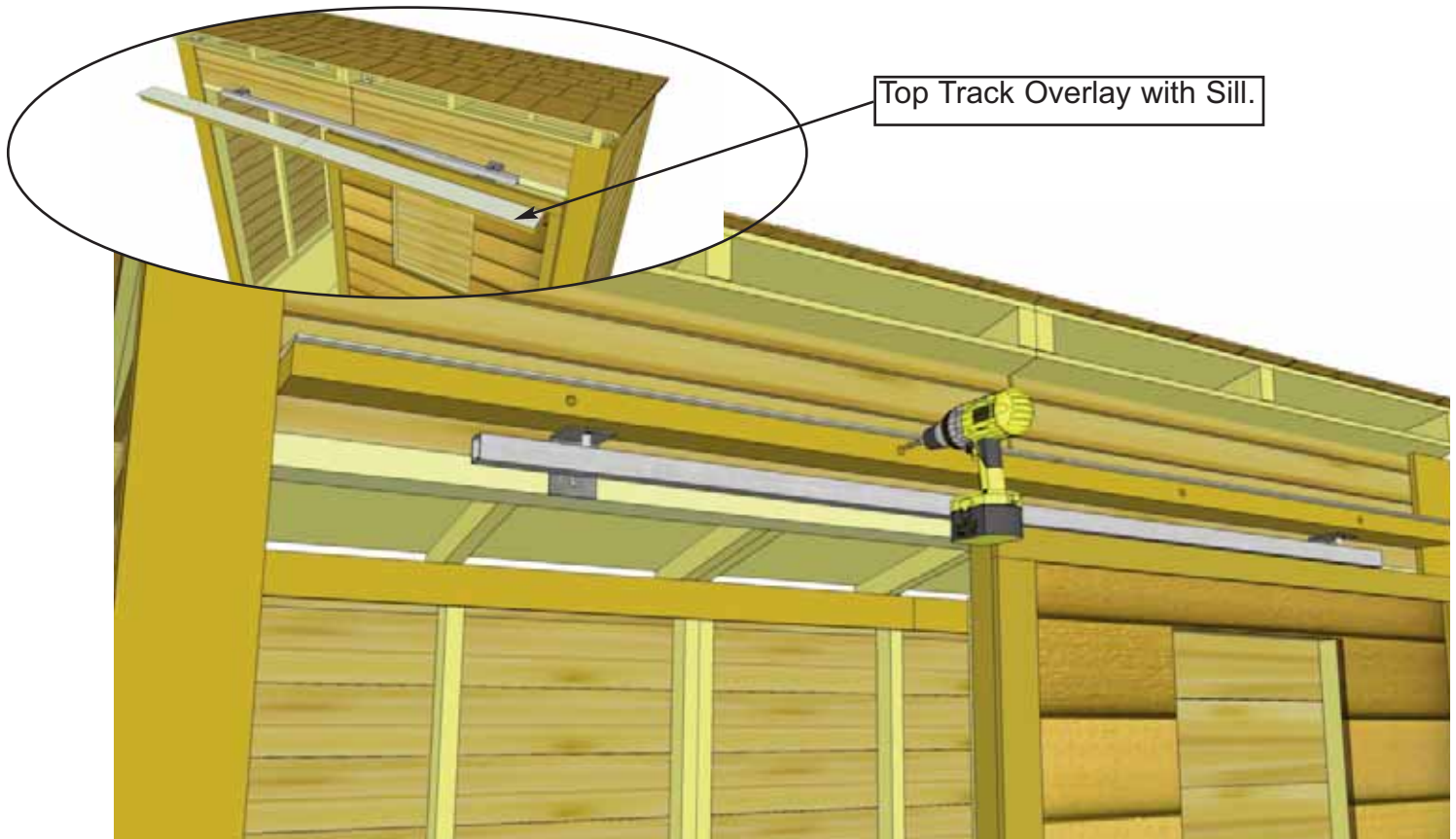

Top Track Overlay with Sill.

63. Position Top Track Overlay directly above Aluminum Door Track. Check level before securing with **6 - 4" Screws**. Edge of overlay has been pre-drilled for screws.

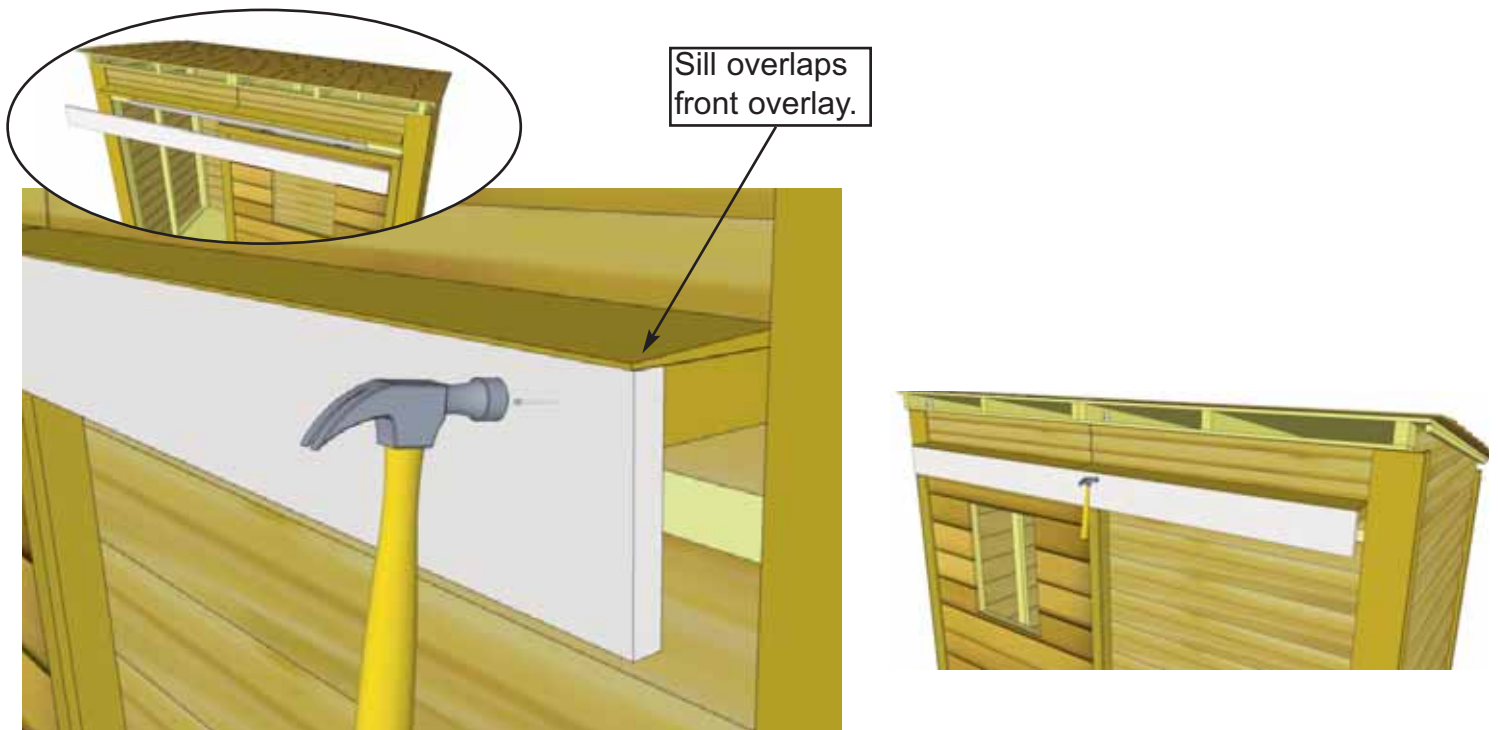

Sill overlaps front overlay.

64. Locate **Top Track Overlay - Front** (3/4" x 5 1/2" x 87 3/4"). Position front overlay underneath sill. Attach with **12 - 1 1/2" Finishing Nails**.

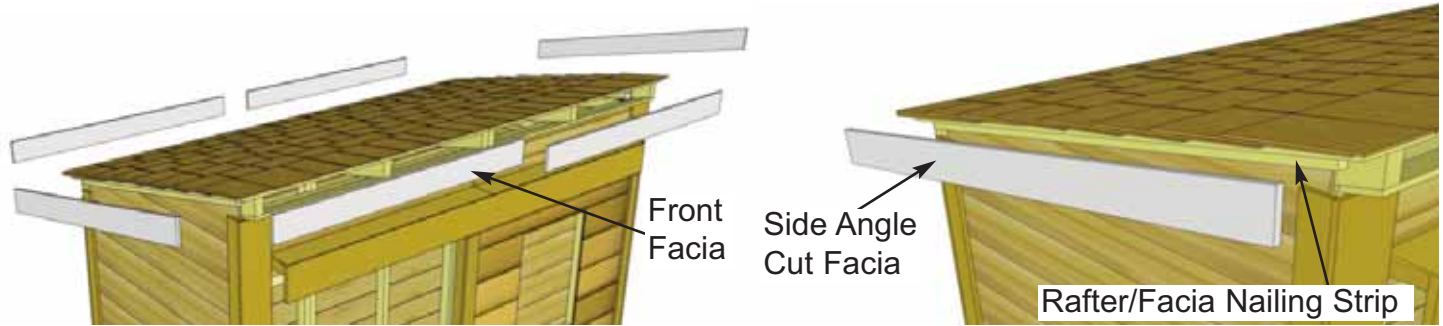

65. Locate and identify all Facia pieces: **Front & Rear Facia** (4 @ 1/2" x 4" x 50 1/2").
Side Angle Cut Facia (2 @ 1/2" x 4" x 54 1/8"). In front corner, align side and front Facia together. Front facia will cap side facia.

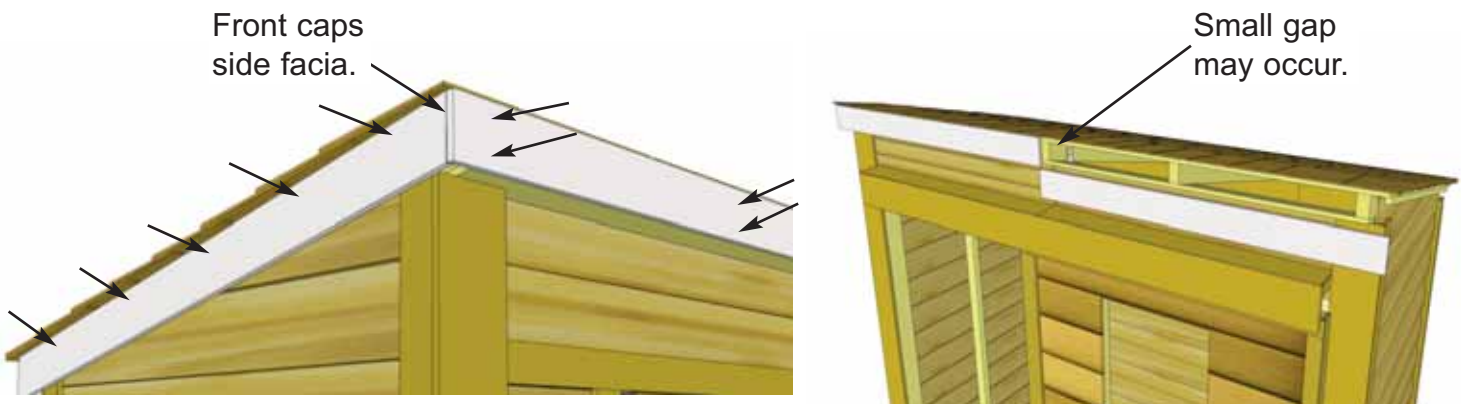

66. Do a dry run first before securing. Position Front Facia up underneath roof panel and against rafter ends. Have your helper hold in position. Place angle cut Side Facia underneath roof panel against Rafter/Facia Nailing Strip. Align so Front Facia caps Side Facia and then attach the front with **6 - 1 1/2" Finishing Nails**. Attach side with **5 - 1 1/2" Finishing Nails** securing them into the nailing strip (closer to the top of the side facia board). Attach next piece of Front Facia. **Note:** With Front Facia correctly aligned at corners, a small gap may occur at center seam. This will be covered by Facia Detail Plate in **Step 70**.



67. Place and align rear and side facia for best possible fit with rear capping side facia. Attach facia to rafter ends with **6 - 1 1/2" Finishing Nails** per piece. Complete both rear facia pieces.

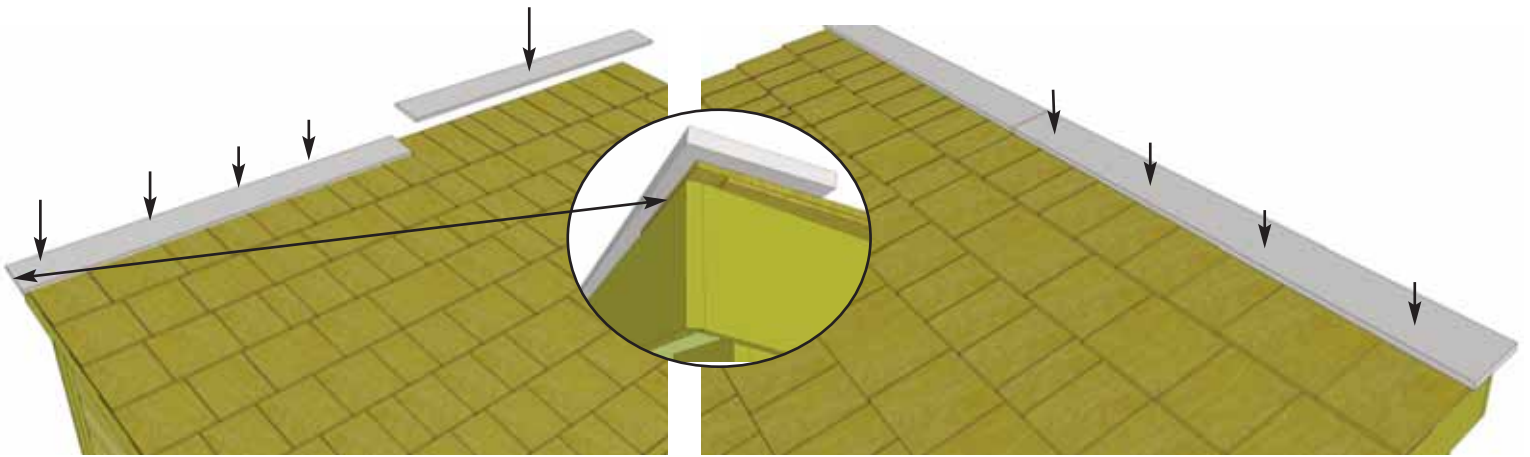

68. Position first **Roof Ridge Board** (2 @ 1/2" x 4 1/2" x 51 5/8") at the front of roof to cap off shingles and fascia. Ridge Boards should meet on seam of roof panels. When aligned correctly, attach with **4 - 1 1/2" Finishing Nails** per piece.

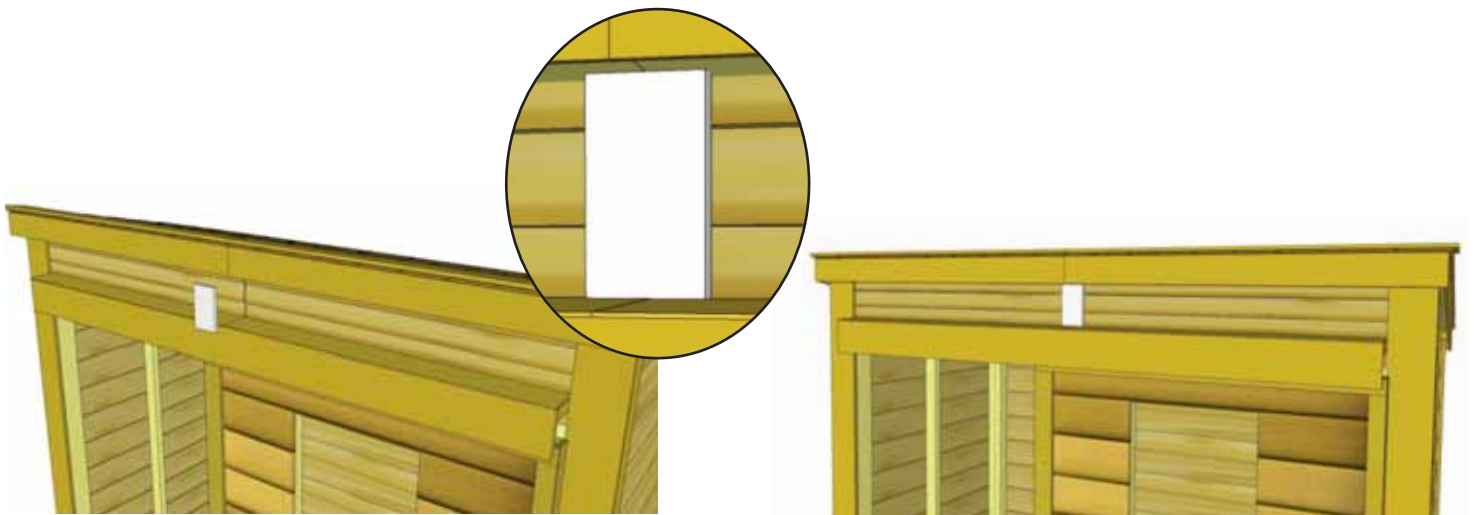

69. Position **Front Middle Trim** (1/2" x 2 1/2" x 6 1/4") on wall seam in top front. Position as shown above and attach with **3 - 1 1/2" Finishing Nails**.

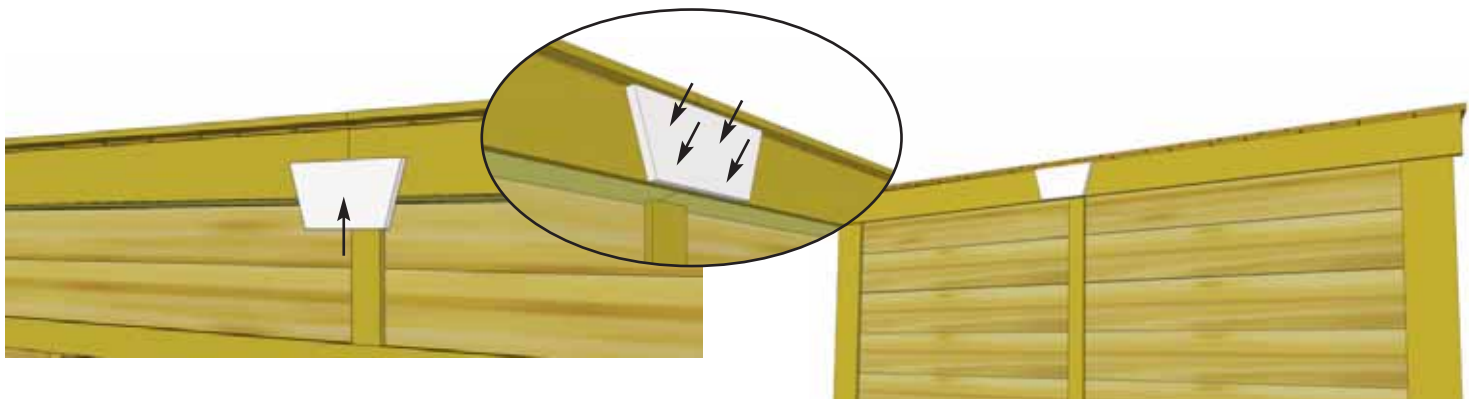

70. Attach **Fascia / Detail Plates** to cover seams where Front and Rear Fascia pieces come together. Secure with **4 - 1 1/2" Finishing Nails** per piece.

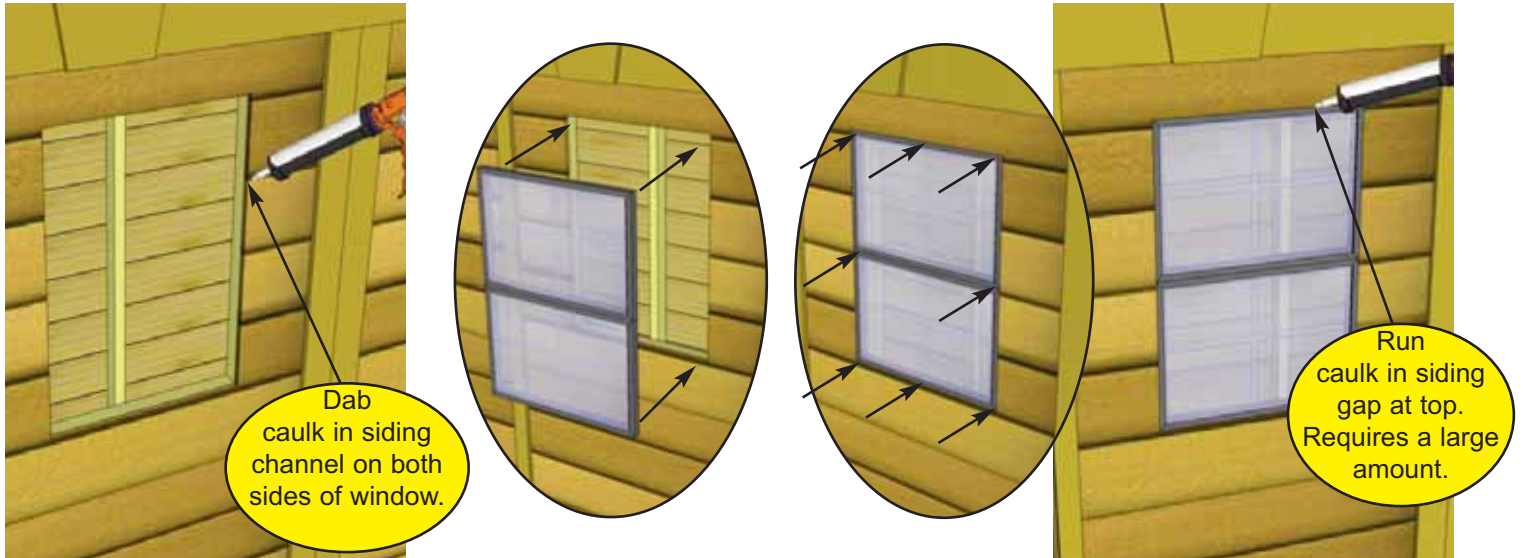

71. Locate **Window Insert**. Before installing, dab caulk in siding channel on both sides of window opening. This will prevent water from getting in behind window. Position window in cavity and secure with **8 - 1 1/4" Screws**. Caulk gap between siding and window at top. This requires a large amount of caulking but is important to fill. Later, Window Trims will be installed to hide caulking.

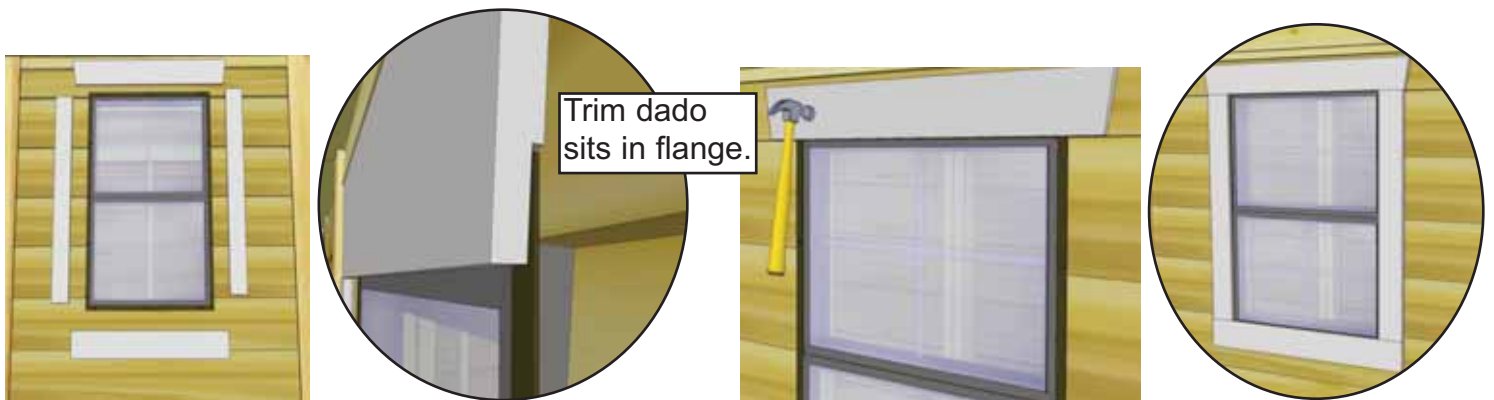

72. Position **Window Trim** around window doing a dry run first and attach with **4 - 1 1/2" Finishing Nails** per piece. Window trim has a small dado on reverse face. Outside flange of window will roughly sit in the dado to give a better fit.



73. Attach **Door Handles** and **Black Hasp** as shown above. Handles and Hasp mounted with **3/4" Black Screws**.



74. After opening the sliding door all the way, position **Interior Door Header** (1 @ 1 1/2" x 2 1/2" x 44") underneath door header such that it is aligned with the front of the door header. Attach with **3 - 2 1/2"** screws.

**Thanks for reviewing the
8x4 Garden Saver**
please email us with any and all questions

Made with North American Western Red Cedar

www.CedarShedAndGardenKits.com info@CedarShedAndGardenKits.com

Note: Our Sheds are shipped as unfinished products. If exposed to the elements, the western red cedar lumber will weather to a silvery-gray color. If you prefer to keep the cedar lumber looking closer to the original color, we suggest that you treat the wood with a good oil base wood stain. You may also wish to paint your new shed rather than stain it. In both cases we recommend that you consult with a paint and stain dealer in your area for their recommendations.



We value your feedback and would like to hear back from you on how well we are doing in the following areas:

- 1. Customer Service**
- 2. On Time Shipping**
- 3. Motor Freight Delivery**
- 4. Quality of Materials**
- 5. Assembly Manual**
- 6. Overall Satisfaction.**

**Please email John and Pat Motley at
info@CedarShedAndGardenKits.com**

The materials contained in this Assembly Manual may be downloaded or copied provided that ALL copies retain the copyright and any other proprietary notices contained on the materials. No material may be modified, edited or taken out of context such that its use creates a false or misleading statement or impression as to the positions, statements or actions.